



AQUACULTURE



FOOD & BEVERAGE



IRRIGATION



POOLS & SPAS



WATER TREATMENT

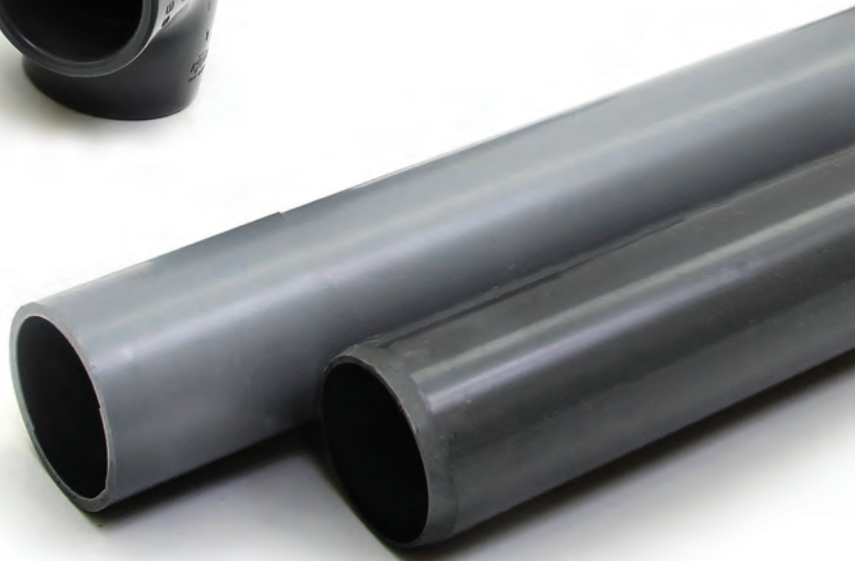

Technical Catalogue

ASTORE OFFER TWO DIFFERENT PVC-U PIPE OPTIONS...
Can you spot the difference?



Optima

Standard PVC-U pipe

Approvals:

- WRAS Approved

Applications:

- Typical PVC-U applications



Premium

Fully approved PVC-U pipe

Approvals:

- WRAS Approved
- BSI Kitemark licensed
- Regulation 31, 'List of approved products' published by the DWI

Applications:

- Drinking water supply
- Water treatment



> INDEX

> INTRODUCTION	4-5
> TECHNICAL INFORMATION	6-18
> ABS PVC-U	19-69
> IMPERIAL	20
PVC-U Premium	20
PVC-U Optima	21
ABS Pipe	22
Fittings Plain	23-26
Fittings Plan/Threaded	27-29
Fittings Threaded	30-33
Flanges	34-37
Valves	38-44
Accessories	45-46
> METRIC	47
PVC-U Premium	47
PVC-U Optima	47
Fittings Plain.	48-52
Fittings Plain / Threaded	53-57
Flanges	58-60
Backing Rings	60-61
Valves	61-65
Actuated Valves	66-67
Accessories	68-69
> CLAMP SADDLES	70-75
> COMPRESSION FITTINGS	76-86
> TERMS AND CONDITIONS	87

>INTRODUCTION

Founded in 1970, Astore continues to offer cost effective thermoplastic pipe, fittings and valves in both ABS and PVC-U to a wide range of market sectors.

Our range of fully matched systems are ideally suited for a variety of applications where lightweight, high quality and durable pipework is required.

As an indication of commitment to quality manufacture, Astore PVC-U and ABS are UK Water Regulations Advisory Scheme (WRAS) approved. Furthermore, the Italian Institute of Plastics (IIP) has granted certificates of conformity in compliance with UNI EN ISO 9002 (Certificate No 354).

Astore PVC-U Premium pipe is listed within 'List of Approved products published by the DWI' Astore manufactures two ranges of PVC-U pipe (Optima & Premium). Only Premium pipe is fully approved by Regulation 31.

Astore products are available via a network of approved stockists across the UK.

Astore products have been used for the conveyance of a range of fluids in the following market sectors for many years;

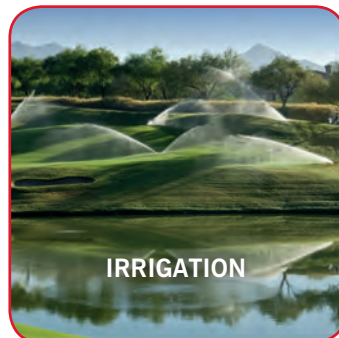

>INTRODUCTION

STANDARDS AND APPROVALS

Astore products are manufactured in accordance with the following standards:

Astore is an ISO 14001 certified company.

Astore PVC-U pipe:

Imperial BS EN 1452-2

Metric DIN 8061-2 KIWA 49 (REV.1)

Astore PVC-U is listed in the 'list of approved products' published by the DWI.

Astore PVC-U fittings:

Imperial BS 4346 Part 1

Threaded BS 21, ISO R7 DIN 2999, ISO UNI 228/1

Metric ISO 727, EN 1452, KIWA 54

PVC-U fittings are UK Water Regulations Advisory Scheme approved and listed (Certificate 1403092).

Astore ABS pipe: BS 5391 Part 1

Astore ABS fittings: BS 5392 Part 1

Astore ABS fittings are UK Water Regulations Advisory Scheme approved and listed (Certificate 1212154).

Unrivalled Third Party Standards and Approvals



ISTITUTO ITALIANO DEI PLASTICI
CERTIFICATO n. 354
CERTIFICATE no. 354
UNI EN ISO 9001

Fast, Simple and High Integrity Jointing

Solvent welding is a simple process which produces a permanent joint of strength equal to, or exceeding, the pipe itself. No special tools, equipment or hot works permits are required.

- No electricity required
- No flame or combustible gas bottles required on-site
- No site downtime due to electricity shut down
- No hot works permits or need for site segregation
- Permanent, secure jointing
- No special tools needed
- Easy transition to other systems
- Reduced installation time
- Reduced installation costs
- Light and easy to handle



Lightweight

Astore is approximately one-sixth of the weight of steel pipework. Therefore, Astore is much easier to handle, especially during installation on-site.



Copper pipe vs ABS pipe



Copper vs ABS

Corrosion and Limescale Resistant

Both limescale and corrosion can become a problematic feature of any metal-based pipework system. However, the smooth bore lining of Astore pipework prohibits any limescale build-up throughout the life of the system, maintaining consistent flow rates.

Furthermore, Astore is extremely corrosion resistant even with a range of moderate chemicals which can mean less maintenance costs and no costly system replacement.



Steel pipe

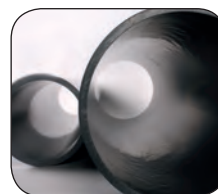

Plastic pipe

> TECHNICAL INFORMATION

Maximum pressure/temperature relationship

When temperature of contents exceeds 20°C the working pressure of the system must be reduced accordingly (see table below).

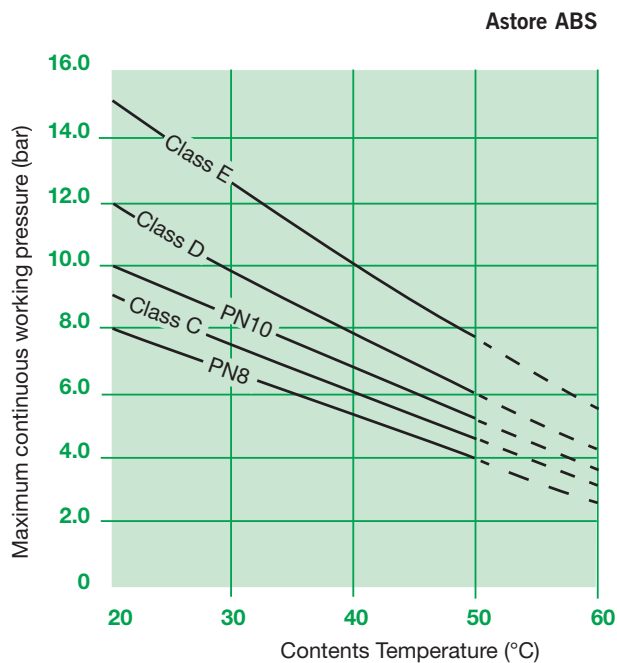

Fittings

The calculation of pressure drop in fittings is more complex but calculations can be made for equivalent lengths of straight pipe using the formula $E = F \times D$ where:

E = equivalent pipe length (metres)

F = fittings constant (see table below)

D = fitting internal diameter (mm)

To calculate the total pressure drop in the system, the equivalent straight pipe lengths for fittings is then added to the total straight pipe length to obtain the total drop.

Fittings constant

90° elbow	0.03
45° elbow	0.01
90° tee - straight through	0.01
90° tee - side branch	0.06
90° bend	0.01
45° bend	0.01
Reducing bush (per size reduction)	0.015
Butterfly valves	0.13
Diaphragm valves	0.23
Check valves	0.05

The values are included as a guide to aid calculation of overall system performance and should not be used in isolation.

Flow calculations

Pressure drop due to friction in pipes conveying water can be determined using the Flow Nomogram on page 7.

The pressure drop at a given flow rate can be determined as follows:

1. Obtain the internal diameter of the pipe to be used (Can be found in the pipe dimensional section on Page 21-22):
2. Mark this diameter on Scale A.
3. Mark the required flow rate in litres per second on Scale B.
4. Draw a straight line connecting the points on Scales A and B and extend this to Scales C and D.
5. The velocity of flow in metres per second is determined from the intersection with Scale C.
6. The frictional head loss in metres per 100 metres of pipe can then be read off Scale D.

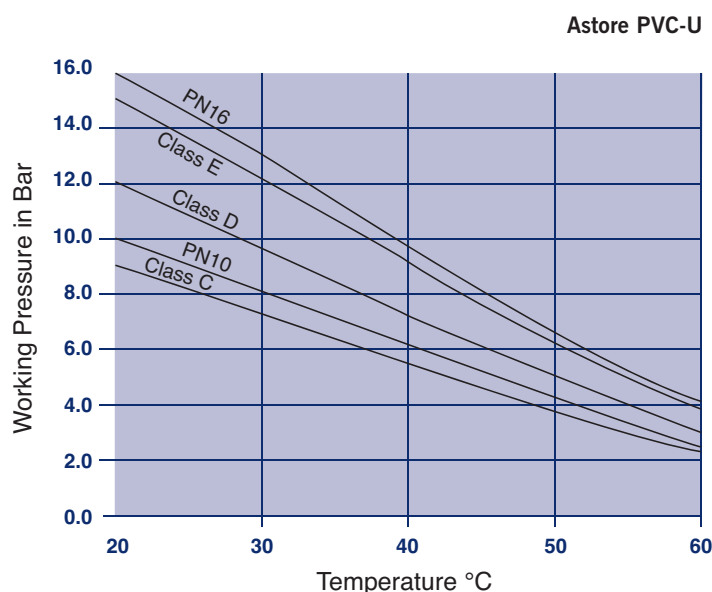

> TECHNICAL INFORMATION

FLOW NOMOGRAM

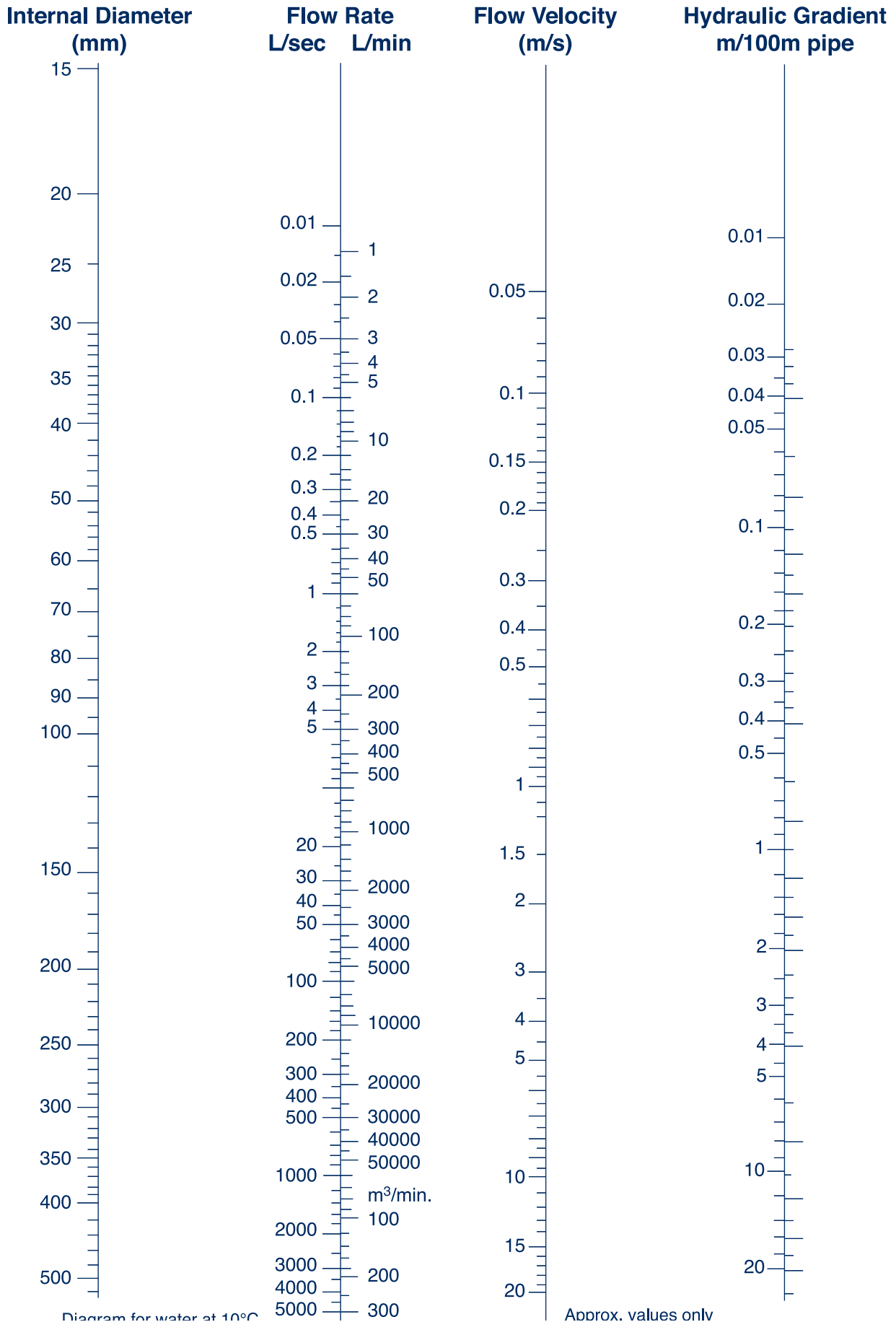

> TECHNICAL INFORMATION

Pipe routing

Systems installed above ground should be designed such that there are sufficient changes in direction to accommodate expansion or contraction. The support method described below will ensure that the pipework can move axially, without snaking. Utilise all available pipe flexibility. Do not place clips too close to changes in direction.

Calculating expansion and contraction

Temperature variations in a pipework system will increase or decrease the length of each pipe. This is the result of temperature changes in the fluid carried and also from ambient temperature variations. The rate of expansion or contraction of pipework is dependent on its length, its coefficient of expansion and the temperature difference.

Increase/decrease in pipe length is given by the formula:

$$\text{Expansion} = L \times \alpha \times \Delta T$$

where: L = length (mm)
 α = coefficient of linear expansion
 ΔT = temperature difference of the pipe (°C)

The coefficient of linear expansion for ABS:
 10×10^{-5} per °C

Rule of thumb: ABS expands/contracts 1mm/metre/10°C temperature change

The coefficient of linear expansion for PVC-U:
 7×10^{-5} per °C

Rule of thumb PVC-U expands/contracts: 0.7mm/m/10°C

Example:

What is the expansion/contraction of an insulated, 30m long, ABS Condenser water main, installed at 15°C, operating at a maximum temperature of 35°C and a minimum temperature of 5°C?

Expansion:

$$\begin{aligned} L &= 30,000 \text{ mm} \\ \alpha &= 10 \times 10^{-5} \\ \Delta T &= 35 - 15 = 20^\circ\text{C} \end{aligned}$$

$$\begin{aligned} \text{Expansion} &= 30,000 \times 10 \times 10^{-5} \times 20^\circ\text{C} \\ &= 60\text{mm} \end{aligned}$$

Contraction:

$$\begin{aligned} L &= 30,000 \text{ mm} \\ \alpha &= 10 \times 10^{-5} \\ \Delta T &= 15 - 5 = 10^\circ\text{C} \end{aligned}$$

$$\begin{aligned} \text{Contraction} &= 30,000\text{mm} \times 10 \times 10^{-5} \times 10^\circ\text{C} \\ &= 30\text{mm} \end{aligned}$$

Hence the system must be designed, using expansion loops, the natural flexibility of pipe, or expansion bellows, to cater for a differential movement, with an expansion of 60mm and a contraction of 30mm.

The system should be designed to cater for the greater amount of movement of either expansion or contraction.

Catering for pipe movement

Systems installed above ground should be designed to ensure that there are sufficient changes in direction to accommodate expansion and contraction. The support method described later will ensure that the pipework can move axially without snaking. If sufficient changes in direction are not available within the design of the system, alternative methods of catering for pipe movement can be considered such as expansion loops or flexible rubber bellows.

Expansion loops

The length of unrestrained pipe (free leg length) required to accommodate expansion can be calculated from the graph overleaf.

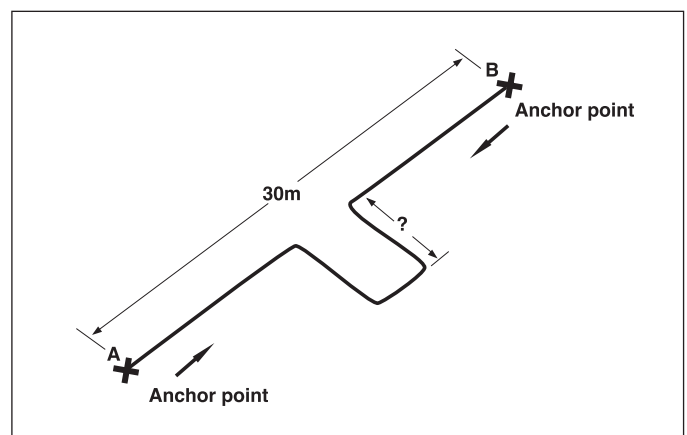
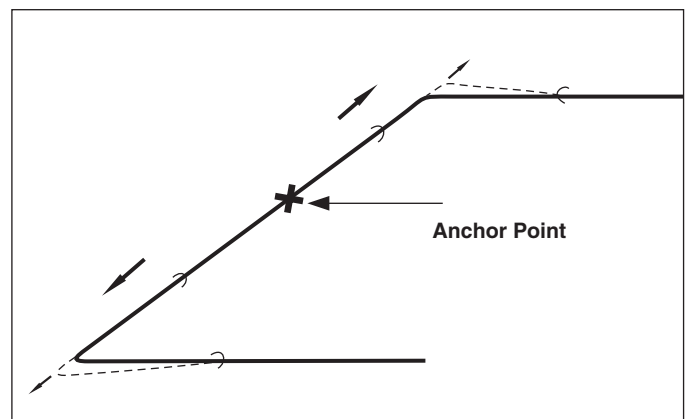
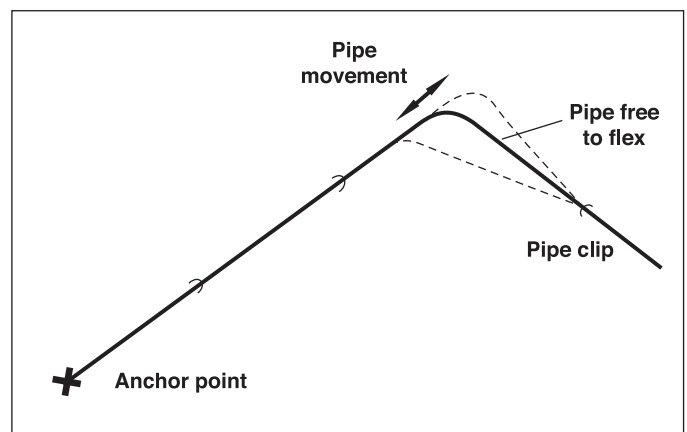

> TECHNICAL INFORMATION

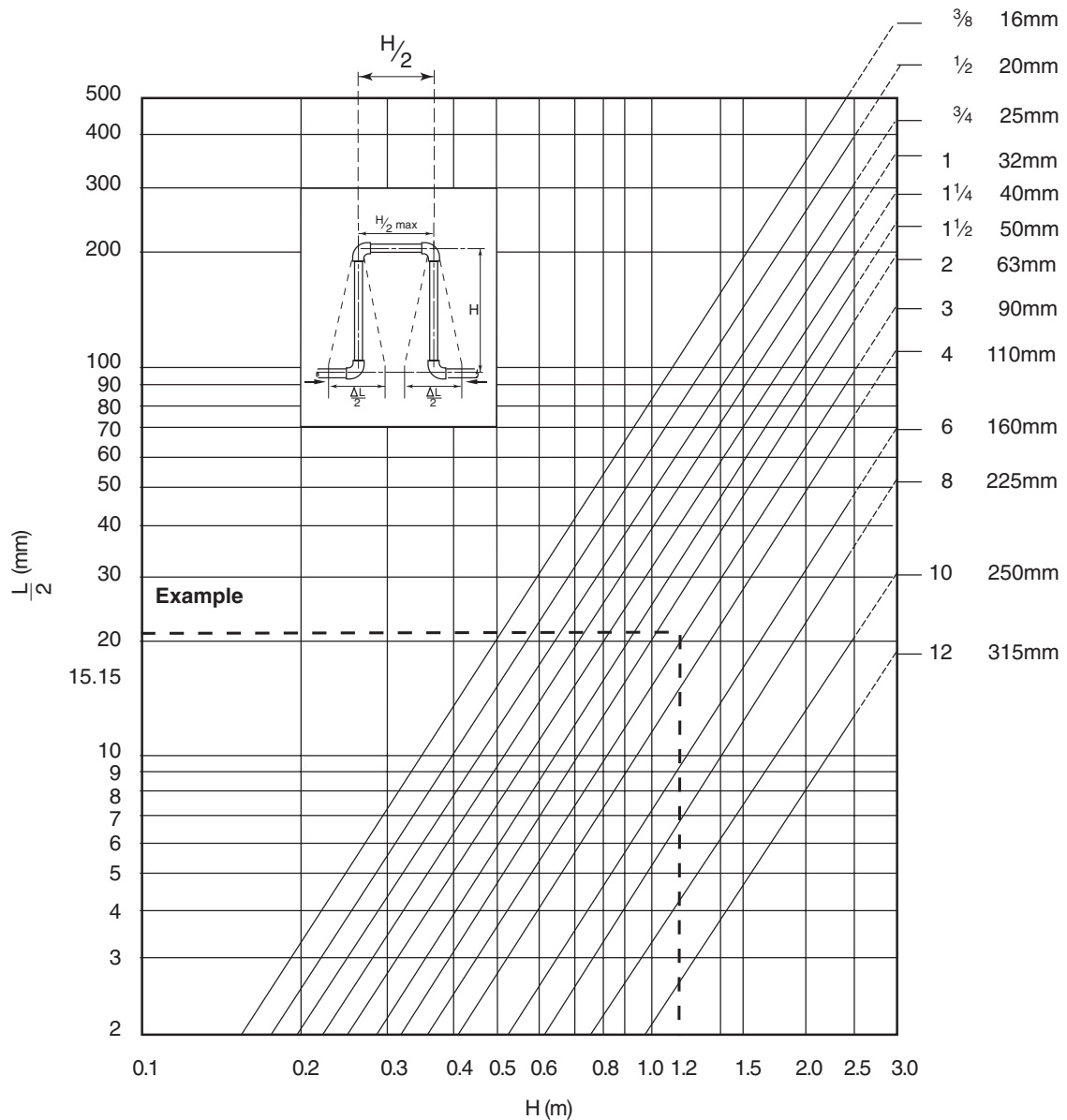

Example:

Calculate the size of expansion loop required for a 3" diameter pipe expanding 42mm and contracting 21mm:

Based on the worst case ie. 42mm expansion, $\frac{\Delta L}{2} = 21\text{mm}$

Draw a horizontal line from the vertical section to meet the 90mm pipe gradient line.

Drop a perpendicular from the intersection point to the horizontal scale. The figure obtained is the free leg length of the loop required.

Hence, in this instance a loop measuring 1200mm long x 600mm wide will cater for $\pm 21\text{mm}$ movement i.e. the loop will cater for both the expansion and contraction of the pipe.

> TECHNICAL INFORMATION

Expansion bellows

Axial expansion bellows may also be used in place of utilising the natural flexibility of the pipework. These must be of a suitable design to ensure correct operation with the pipework.

Typical bellows arrangement

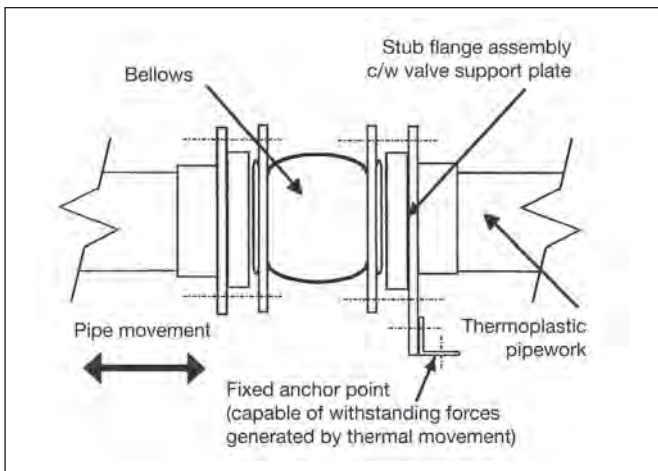

Anchor points

The direction of pipe movement can be controlled by the use of anchor points at strategic positions. There are a number of methods of securely anchoring plastic pipes, some of which are detailed below. However it should be noted that tight fitting pipe supports or U bolts should not be used since damage to the pipe could occur.

Construction of typical anchor points

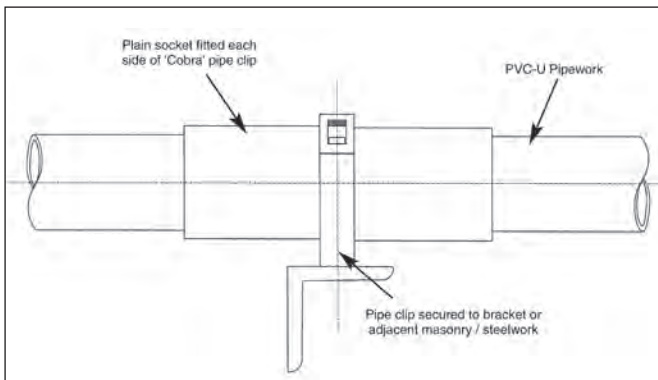

1. Small Bore (up to 4" Pipework)

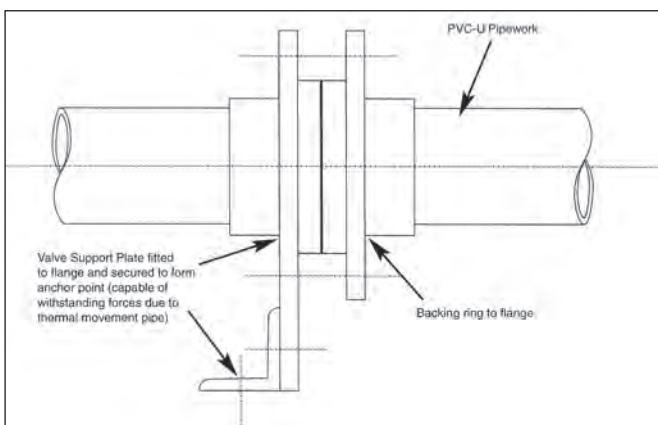

2. Larger pipe (above 4" Pipework)

Pipe supports and clips

Pipe supports and clips should provide lateral restraint and allow free, unrestricted, axial pipe movement. Standard 'drop rods' may not provide sufficient lateral restraint and the pipe could start to 'snake'.

Support centres

The recommended distance between supports for pipes filled with water is given in the table below. Where the contents have a specific gravity greater than 1 the distance must be decreased by dividing the recommended centre distance by the specific gravity. For vertical pipes, support centres may be increased by 50%.

PVC-U Support distances

metric	imperial	20°C	30°C	40°C	50°C
20	½	0.90	0.85	0.85	0.80
25	¾	1.00	0.95	0.90	0.90
32	1	1.10	1.05	1.00	1.00
40	1¼	1.30	1.25	1.20	1.15
50	1½	1.50	1.45	1.40	1.35
63	2	1.60	1.55	1.50	1.45
75	2½	1.80	1.75	1.70	1.60
90	3	2.10	2.05	1.95	1.90
110	4	2.40	2.30	2.25	2.10
125		2.50	2.40	2.35	2.20
140	5	2.70	2.60	2.55	2.40
160	6	2.90	2.80	2.70	2.60
200		3.20	3.10	3.00	2.90
225	8	3.45	3.30	3.25	3.10
250		3.60	3.45	3.40	3.25
280	10	3.80	3.65	3.55	3.40
315	12	4.10	3.95	3.85	3.70

ABS Support distances

imperial	20°C	50°C	60°C
3/8"	0.8	0.5	0.4
1/2"	0.9	0.6	0.5
3/4"	1.0	0.7	0.6
1"	1.1	0.8	0.7
1¼"	1.2	0.9	0.7
1½"	1.3	1.0	0.7
2"	1.4	1.1	0.8
2½"	1.5	1.2	0.8
3"	1.6	1.2	0.9
4"	1.8	1.3	1.0
5"	2.0	1.5	1.1
6"	2.1	1.6	1.2
8"	2.3	1.8	1.5

> TECHNICAL INFORMATION

Support of heavy equipment

Large valves, strainers and other heavy equipment should always be independently supported to prevent undue loading onto the system. Valve support plates have been designed for this purpose and may be used in place of flange backing rings.

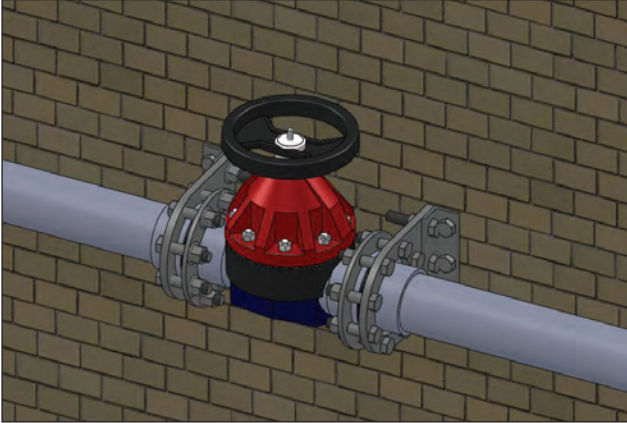

Anchor blocks

For wholly solvent welded systems the pipework is pressure balanced and anchor thrust blocks are not required. When rubber ring joints are used it is necessary to provide concrete anchor blocks of changes in direction such as elbows, bends, tees etc. This is necessary to withstand the forces generated by system pressurisation.

For greater detail, users in the U.K. are recommended to study the Code of Practice CP 312 published by the Pipe and Fittings Group of the British Standards Institute covering installations above and below ground.

Buried pipes

Recommendations covering essential requirements for installations below ground may be summarised as follows:

In general, trenches should not be less than a metre deep. Trenches should be straight sided, approximately 300mm wider than the pipe diameter to allow proper consolidation of packing materials. Trench bottoms should be as level as is practical.

Large pieces of rock, debris and sharp objects should be removed.

Alternatively gravel can be laid approximately 100mm deep on the floor of the trench. (Sand may be used but subterranean water is liable to wash sand away and leave the pipe unsupported.)

If pipes are jointed above ground, they should remain undisturbed for 2 hours before being lowered into the trench.

After laying, pipes should be covered with gravel or similar material to a depth of 100mm above the crown of the pipe. The gravel should be extended sideways to both trench walls and compacted. This should be done prior to testing, with joints left exposed.

Care should be taken to ensure that sharp objects, stones, etc, are prevented from falling into the trench before covering the pipe.

After pressure testing, joints should be covered with gravel or similar material, and back filling completed.

A section of pipe installed below ground to the above recommendations is shown in the illustration.

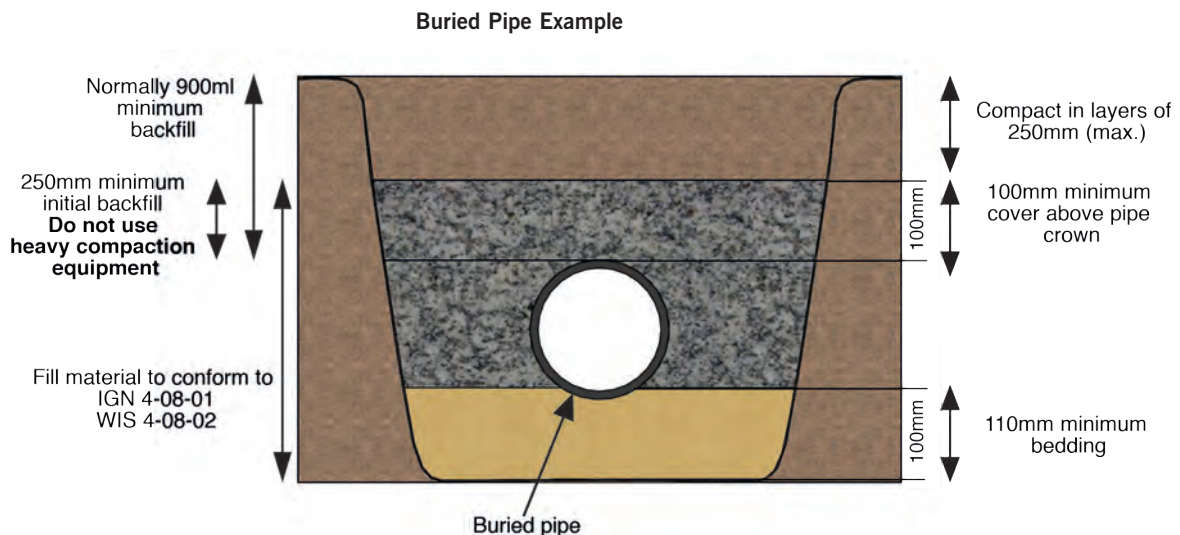

> TECHNICAL INFORMATION

THREADED CONNECTIONS

Connections - plastics to metal

There are several recommended methods to connect metal and plastic systems:

Composite unions Flanges
Male threaded fittings Female threaded fittings

Plastics expand or contract more than metals for any given change in temperature. The practice of connecting plastic threaded fittings to metal threads is not recommended where the joint is likely to experience a temperature change of more than +/-5°C, otherwise leaks may occur.

Composite unions are available with brass male or female BSP threaded adaptors.

If it is required to cut a thread onto pipe, use a sharp die especially reserved for plastic pipes and cut full thread depth without lubricant, in one operation.

This should only be attempted on pipe sizes up to 2" NB. Class T pipe must be used. (Metric series pipe not suitable for threading).

Assembly should be carried out by hand and final tightening by a strap wrench, if necessary.

Extra care must be taken not to overtighten or damage the thread.

Pipe wrenches must not be used

It is recommended that PTFE tape or Fibreseal be used when making plastic threaded joints/connections.

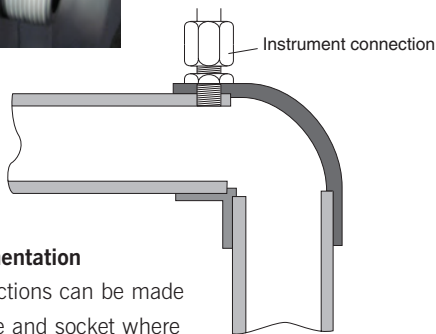

Connection to instrumentation

Instrumentation connections can be made by drilling through pipe and socket where the material is at its thickest and tapping the hole to receive a threaded fitting, as shown below:

Pipe size	Connection size
16mm-63mm/3/8"-2"	Use tees, reducing bushes and threaded fittings
75mm-110mm/2 1/2"-4"	Max. tapping 1/2" BSP
125mm-140mm/5"	Max. tapping 3/4" BSP
160mm & above/6" & above	Max. tapping 1" BSP

Such connections, if correctly drilled and tapped with full thread form, will be limited to Class C/PN10 pressures.

Flanged joints

Full face flanges are available from 1/2" to 4". Or 20mm to 110mm. Stub flanges are available from 1/2" to 12" and in metric sizes from 20mm to 315mm and provide a convenient means of converting from Imperial to Metric systems in sizes 8"/200mm and above (PVC-U only).

The correct backing ring must be used with stub flanges.

Flange bolting procedure

The following procedure is recommended for installing flanges:

1. Inspect flange faces and ensure that they are clean and undamaged.
2. Check that the correct backing ring (stub flanges only) and rubber gaskets have been supplied. Care should be taken when mixing Metric and Imperial components.
3. Loosely assemble flanges. Ensure that flanges and bolt holes align and that the flange faces are parallel. Ensure that the gasket is correctly positioned between the flanges.
4. Ensure that the appropriate sized washer is placed under both bolt heads and nuts.
5. Tighten the nuts and bolts in a diagonally opposite sequence (see below) to ensure even loading around the flange to avoid distortion. It is recommended that the nuts and bolts be tightened as uniformly as possible progressively from a finger tight start.
6. Repeat as necessary until tightness of all bolts is achieved.

Tightening torques for flange bolts in piping systems

Recommended Torque Values (Nm)

Size	Torque
16mm - 3/8"	15
20mm - 1/2"	15
25mm - 3/4"	15
32mm - 1"	15
40mm - 1 1/4"	20
50mm - 1 1/2"	30
63mm - 2"	35
75mm - 2 1/2"	40
90mm - 3"	40
110mm - 4"	40
125mm	50
140mm - 5"	50
160mm - 6"	60
200mm	70
225mm - 8"	70
250mm - 10"	80
315mm - 12"	100

The tolerance on torque is +/-10%

Tightening sequence

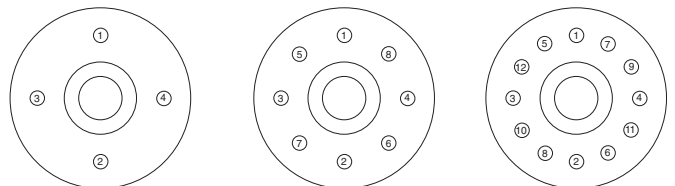

> TECHNICAL INFORMATION

JOINTING PROCEDURES

The solvent cement operates by chemically softening the outside of the pipe and the inside of the fitting. Joint integrity is greatly reduced if these surfaces are not absolutely clean and properly prepared.

1) The pipe must be cut clean and square. A suitable wheel cutter will eliminate swarf. A saw may be used, however this will create dust which may enter the pipework system.



2) Chamfer the pipe, approximately 3mm to 5mm depending upon pipe size using a chamfering tool or coarse file. This prevents the solvent cement layer being scraped from the surface of the fitting when the joint is assembled.

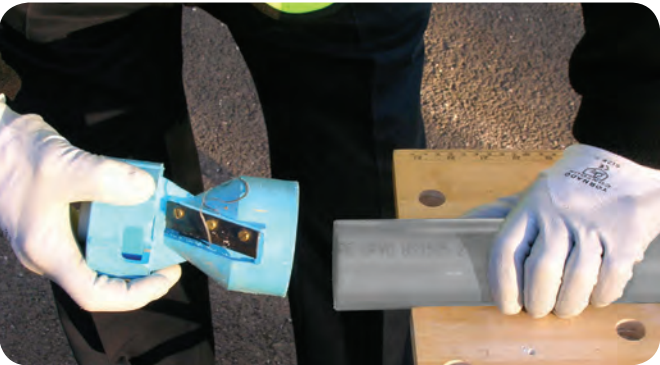

3) Mark the pipe a known distance from the end and clear of the area to be abraded. This should be used to check the pipe penetration into the socket after assembly.



4) Thoroughly abrade the end of the pipe over a length equal to depth of the fitting socket, using clean coarse emery cloth.

5) Thoroughly abrade the inside surface of the fitting socket.

6) Clean thoroughly the abraded surfaces of pipe and fittings using a clean, lint free cloth or paper towel, moistened with Astore Eco-cleaner.



7) Using a clean brush, apply the Astore solvent cement to the pipe and fitting using longitudinal strokes. The abraded areas should be completely covered with the cement. The amount required will vary with pipe diameter and the fit between pipe and fitting, but should be such in all cases that the cement is still liquid when pipe and fitting are assembled. It is important to apply cement quickly, to enable assembly without excessive force being required.



Note

The images in this demonstration show ABS pipework being jointed. The same procedure applies to PVC-U pipework.

> TECHNICAL INFORMATION

JOINTING PROCEDURES

8) Immediately after application of cement, push pipe fully home into the fitting. Do not twist. Hold the pipe and the fitting for times varying from a few seconds on sizes 3/8" to 1 minute on sizes 8" and above. Application of the correct amount of cement will result in a neat bead of cement at the edge of the fitting and the pipe. Excessive deposits inside the pipes & fittings must be avoided as these can weaken the wall, particularly on small sizes. When working under cold conditions make sure the joints are free from frost and moisture and allow extra curing time to compensate for the lower temperature.



9) Wipe off excess cement from outside of the joint.

The drying time for joints will vary with fit, amount of solvent cement applied, ambient temperature and working pressure. It is recommended that whenever possible, joints are left to cure for 24 hours before the test pressure is applied (up to 8"/225mm). However, it is recognised there will be times when joints will need to be put into service within a few hours of being made. A rough but safe working guide, where contents temperature will not exceed 20°C, is 1 hour per bar for systems up to 4". For larger sizes increase this time to 1½ hours per bar. In any event joints should be allowed to cure for a minimum of 4 hours.



10) Using the mark previously made, check that the pipe has been fully inserted.



11) Do not disturb the joint for at least 10 minutes after assembly. On larger sizes do not subject the joint to bending or twisting forces for at least 4 hours (see below). When making subsequent joints, which can be done without waiting, take care not to transmit forces to freshly made joints in the system. Allow sufficient drying time prior to pressurisation of the system (see page 15).

12) Replace lids on containers.

CAUTION

- DO NOT use near naked flames
- DO NOT smoke in the working area
- DO NOT use in confined spaces
- DO NOT joint in the rain or wet conditions
- DO NOT use dirty brushes
- DO NOT use dirty or oily cleaning cloths
- DO NOT use the same brushes for different cements
- DO NOT dilute or decant Astore solvent cement
- Follow safety instructions on Astore solvent cement and Eco-cleaner containers
- Always wear appropriate personal protective equipment

Notes

1. The integrity of Astore systems may be affected if Astore solvent cement and Astore Eco-cleaner are not used. Astore disclaims responsibility for any Astore system constructed with any other cement or not fabricated in accordance with the instructions herein.
2. To achieve the correct speed of application on sizes 5"/140mm and above, cement should be applied simultaneously to pipe and fitting, by two people.

> TECHNICAL INFORMATION

DRYING TIMES

The drying times will vary with fit, amount of solvent cement applied, ambient temperature and working pressure. It is recommended that, wherever possible, joints of sizes up to 8"/225mm are allowed to dry for at least 24 hours, and sizes 10" and 12"/250mm and 315mm for at least 48 hours for ABS or 30 hours for PVC-U. These guidelines are based on an ambient temperature of between 10°C to 40°C. Longer drying times will be required at lower and higher ambient temperatures.

It is recognised that there will be occasions when the system will need to be put into service within a few hours of being made.

A rough but safe working guide where the ambient temperature is between 10°C to 40°C and the contents temperature does not exceed 20°C is as follows:



Size Range	Up to 2½" 75mm	3" to 4" 90mm to 125mm	5" & 6" 140mm & 160mm	8" 200mm & 225mm	10" & 12" 250mm & 315mm
Drying Time ABS	0.5 hour / bar	1.0 hour / bar	1.5 hours / bar	2.0 hours / bar	48 hours minimum
Drying Time PVC-U	1.0 hour / bar	1.0 hour / bar	1.5 hours / bar	2.0 hours / bar	30 hours minimum

Note - minimum drying period should never be less than 1 hour.

An indication of the number of joints to be made per litre of cement is as follows:

mm	Size		Joints per litre	
	inch		ABS	PVC-U
16 - 32	¾ - 1		400	300
40 - 63	1¼ - 2		200	120
75 - 110	2½ - 4		70	50
125 - 140	5		20	15
160 - 225	6 - 8		10	8
250 - 315	10 - 12		5	3

CHEMICALLY RESISTANT PVC-U CEMENT

For PVC-U applications with the following chemicals we recommend the use of HCR-36 (Product code R PCO.0100) an alternative to our Astore solvent cement. Our Astore PVC-U cement. Always use the appropriate HCR-36 cleaner (Product code M CFO.0100) when using this chemical resistant cement.



Sulphuric acid	concentration higher than 70%
Nitric acid	concentration higher than 20%
Hydrochloric Acid	concentration higher than 25%
Hydrofluoric acid	each concentration
Sodium hypochlorite	active chlorine higher than 7.5%
Lyes, bases (caustic soda)	concentration higher than 35%

Maximum gap 0.3mm

20°C

50°C

60°C

Maximum pressure

12 bar

6 bar

4.5 bar

Maximum pressure depends also on the pipe system used and PN class.

Note: HCR-36 Solvent Cement & Cleaner is only suitable up to 4"/110mm.

> TECHNICAL INFORMATION

ADDITIONAL IMPORTANT INFORMATION

Thermal insulation

Some insulation products can contain substances capable of having a detrimental effect on thermoplastic pipework eg. certain types of foam rubber insulations can cause certain thermoplastics to fail at elevated temperatures.

Recommended insulation - a list of some of the common types of insulation materials known to be suitable with

ABS and PVC-U pipework are as follows:

Fibre wool, such as 'Rockwool'

Armaflex Class 1 HT

Koolphen K Phenolic foam

Polystyrene

Note - the above list is not exhaustive.

Some adhesives can also be detrimental. Do not bond insulation to thermoplastic pipework. (This comment also applies to any tapes, adhesives, or other substances used to secure the heating tape to the pipework. Contact our technical department if you have any concerns.)

Trace heating

Thermoplastic pipework can be damaged by plasticisers used in the outer coverings on some heating tapes. Tapes sheathed in plasticised PVC must be avoided, unless specifically approved by us. (This comment also applies to any tapes, adhesives, or other substances used to secure the heating tape to the pipework.)

Recommended heating tapes

The selection of heating tapes with silicone rubber, woven wire, or woven polyester outer sheaths will eliminate the risk of plasticiser migration. These tapes are therefore preferred for use on thermoplastic systems. For specific advice please refer to heating tape manufacturers.

Pipe contents identification

Do not put self-adhesive labels directly on to pipe surfaces as this may be detrimental to pipe performance. It is recommended that some sort of barrier, such as aluminium foil, is placed between pipe and identification label.

Intumescent mastic and mastic sealants

Certain mastic sealants are formulated with phthalates. Phthalates are known to be extremely aggressive toward ABS and PVC-U materials, and therefore confirmation of the suitability of any mastic sealant should be determined before being used in conjunction with ABS and PVC-U pipework.

Pipe clips

It is important that the composition of pipe clips and their linings do not include substances which might have a detrimental effect upon the ABS & PVC-U pipe. Please check for suitability before use. We strongly recommend the use of Astore pipe brackets for pipe sizes up to and including 110mm OD/4" NB, wherever circumstances allow.

Pneumatic testing

Pneumatic testing not recommended because of the risk to personnel or property if, for example, a joint has been temporarily assembled without solvent cement and has then been mistakenly left in that condition. Such joints could separate suddenly and violently during the test.

Also, leak detection sprays designed to detect air leaks on steel pipework can damage thermoplastics. Care should be taken to ensure only compatible types are used.

Contact with synthetic oils

Some synthetic oils are unsuitable for use with thermoplastic pipe systems. The main types of synthetic oils identified as being incompatible with thermoplastic pipe systems includes Esters, Polyalkylene Glycols, and Organic Phosphates.

It should be noted that some metal coil manufacturers use these oils in their manufacturing process. This is normally drained from the coil. If it is suspected that residues of oil may remain in the coil it should be filled with methylated spirits, then thoroughly flushed with water.

Freezing conditions

Precautions should be taken to prevent contents freezing, as this can cause pipework to split.

For ABS Mono-ethylene glycol can be added to the system to lower the freezing point. See opposite for advice on insulation and trace heating.

Contact with fluxes

Some fluxes can be detrimental to thermoplastic pipework. Care should be taken when soldering copper pipework directly above, or close to, pipework.

Buried pipes

Do not lay pipework in contaminated ground eg. 'brown-field' sites.

Do not lay pipework in ground where spillages of chemicals may occur.

Thread sealants

Some thread sealants can damage plastic pipework. PTFE tape or Fibre Seal should be used when making threaded connections.

Resistance to U.V. (sunlight)

Care should be taken to avoid exposure to U.V. light, eg. sunlight, particularly during storage. This will cause discoloration and deterioration of the material. Whilst this is a surface effect only it is recommended that precautions be taken to prevent this happening. If stored outdoors pipe should be covered with opaque sheeting. If installed outdoors it can be protected from the effects of U.V. by insulating or painting.

Pressure surges

Astore pipework can withstand pressure surges within the limitations detailed within CP312 Part 2:1973 and its amendment dated 1977. On no account should pressure surges be allowed to exceed the maximum continuous working pressure calculated using the graph on page 6.

> TECHNICAL INFORMATION

Health and Safety at Work Act and COSHH Regulations

Attention is drawn to the requirements in the U.K. of this Act and to the 1988 Control of Substances Hazardous to Health (COSHH) Regulations.

Astore UK cannot accept responsibility for accidents arising from the misuse of its products because of bad installation or incorrect application.

Material safety data

Material safety data sheets are available on our website www.astore.co.uk

Filling and flushing

When purchasing chemicals for either flushing or long-term system use, suppliers should be advised of the material it is for. Guidance on the suitability of various system flushing or filling fluids with the various thermoplastics can be found at www.astore.co.uk.

Testing

It is suggested that the following test procedure be followed, after joints have been allowed to dry for the appropriate minimum time.

The system should be divided conveniently into test sections.

Fill the section with cold water making sure that no air pockets remain. Do not pressurise at this stage.

Check the system for leaks. If no leaks are apparent check for and remove any remaining air. Increase pressure up to 3 bar. *Do not pressurise further at this stage.

Leave the section pressurised for 10 minutes. If the pressure decays, inspect for leaks and rectify as necessary. If the pressure remains constant, slowly increase the hydrostatic pressure to 1½ times the nominal operating pressure.

Leave the section pressurised for a period not exceeding 1 hour. During this time the pressure should not change.

Colour

Astore ABS products are a mid-grey colour, generally in accordance with BS5252 and RAL 7001.

Astore PVC-U products are a dark-grey colour, generally in accordance with BS5252 and RAL 7011.

Dimensions and Standards

Astore systems are manufactured in accordance with the following standards:

PVC-U pipe:

Imperial BS 3505 - 3506 EN1452

Metric DIN 8061/-2, KIWA 49 (Rev.1)

ABS pipe: BS 5391 Part 1

PVC-U fittings:

Imperial BS 4346 Part 1, Threaded BS 21, ISO 7 Din 2999

Metric DIN 8063 ISO277/1

Threaded & Transition ISO R7, ISO UNI 228/1, BS 21, Din 2999

ABS fittings: BS 5392 Part 1

Materials

Materials used for the manufacture of Astore pressure pipe fittings and valves are selected for their non-toxic properties and suitability for potable water as required by the appropriate international authorities.

Both ABS and PVC-U comply with ISO 727 and the requirements of the World Health Organisation for potable water transportation.

Gaskets and seals

Gaskets and O-Ring seals are made from EPDM except where stated otherwise.

Interchangeability

Components in the imperial and metric ranges are not interchangeable, except for 2½"/ 75mm and 5"/140mm.

CAUTION

Personnel must stand well clear when pressure testing systems. Similarly, under no circumstances should pressure tests be carried out using pressurised gases. Such a test could be extremely dangerous and does not serve any useful purpose.

*Note:

If extended times are required to achieve hydrostatic pressure, either leakage has occurred or air remains in the line. Inspect for leakage and if none is apparent, reduce the pressure and check for trapped air which must be removed before further pressurisation is commenced.

If a leakage source is difficult to establish it is acceptable to pressure the line using air or nitrogen to a maximum pressure of 1.5 bar. Test joints etc. with a soap solution.

> TECHNICAL INFORMATION

Handling and Storage

Care should be taken at all stages of handling, transportation and storage. Pipe must be transported by a suitable vehicle and properly loaded and unloaded, eg. wherever possible moved by hand or mechanical lifting equipment. It must not be dragged across the ground. The storage should be flat, level and free from sharp stones.

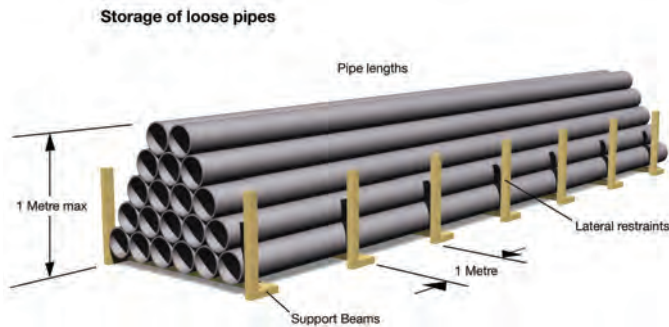

Lengths

Pipe lengths stored individually should be stacked in a pyramid not more than one metre high, with the bottom layer fully restrained by wedges. Where possible, the bottom layer of pipes should be laid on timber battens at one-metre centres.

On-site, pipes may be laid out individually in strings.

(Where appropriate, protective barriers should be placed with adequate warning signs and lamps.)

Bundles

Bundled packs of pipe should be stored on clear, level ground with the battens supported from the outside by timbers or concrete blocks. For safety, bundled packs should not be stacked more than three metres high.

Smaller pipes may be nested inside larger pipes. Side bracing should be provided to prevent stack collapse.

Similar precautions should be taken with fittings and these should be kept in protective wrappings until required for use.

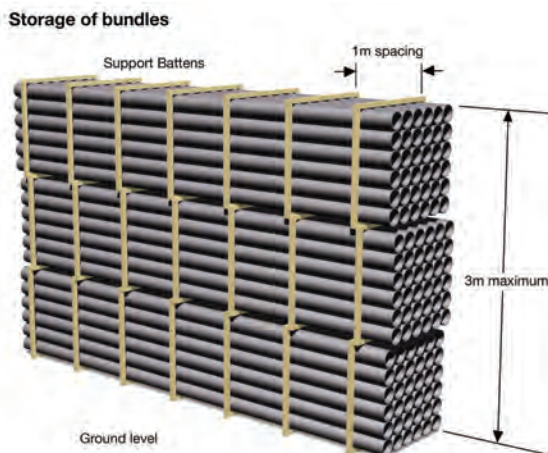

Weathering

Prolonged storage (greater than one month) or storage in areas where high temperature is anticipated, the stack height should never exceed 4 layers or 1 metre maximum height. Such stacks should be protected from the effects of weathering by placing an opaque covering over them. If fixed to the side bracing the sheets will provide protected and shaded conditions and allow a free passage of air around the pipes.

Where the pipes are to be installed in locations likely to be permanently exposed to prolonged periods of strong sunlight, such as in tropical countries, the life can be extended by painting the pipe with household gloss or emulsion. Cellulose based paints should only be used with extreme care and close attention paid to the manufacturers instructions.

Pipe Contents Identification

Do not put self-adhesive labels directly onto pipe surface as this can cause stress cracking. It is recommended that some sort of barrier such as aluminium foil, is placed between the pipe and identification label.

Approvals

Astore products are manufactured in accordance with the following standards:

Astore PVC-U: is Water Regulations Advisory Scheme (WRAS) approved and Listed (Certificate number 1403092).

Astore ABS: is Water Regulations Advisory Scheme (WRAS) approved and listed (Certificate number 1212154).

Astore PVC-U premium pipe is Approved for use within public water supplies & by the Secretary of State. Premium PVC-U pipe is Listed in the list of approved products as published by DWI.

All Astore solvent cements are fully WRAS approved. Contact our customer services team for full details.

> ABS & PVC-U

Astore offers an extensive range of ABS & PVC-U imperial pressure pipework. The full range is accompanied by a wide selection of cost-effective valve options and other accessories including compression fittings and clamp saddles.

ASTORE ABS

Key Product Information

Imperial size range:

½" to 8"

Temperature range:

-40°C to +60°C

Pressure Rating:

Up to Class E

Key Product Features

Lightweight & Easy to install

Fully solvent welded system

Tough & durable even at low temperatures

Wide temperature range



ASTORE PVC-U

Key Product Information

Imperial size range:

½" to 12"

Temperature range:

0°C to +60°C

Pressure Rating:

Up to Class E

Key Product Features

Lightweight & Easy to install

Fully solvent welded system

Corrosion & limescale resistant

Good chemical resistance properties



> PREMIUM PVC-U PIPES

**DURAPIPE UK PREMIUM
PVC-U PIPE (Fully Approved)**

PRC | PVC-U PREMIUM PRESSURE PIPE CLASS C

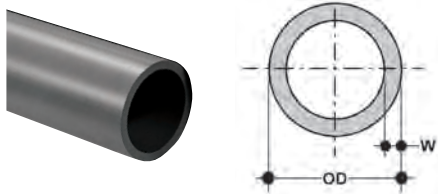

Size	OD mm	Min. Wall (w) mm	Weight kg/m	Code
2"	60.3	2.8	0.73	R PRC.0630
3"	88.9	3.8	1.05	R PRC.0900
4"	114.3	4.9	2.43	R PRC.1100
6"	168.0	7.1	4.89	R PRC.1600
8"	218.8	8.4	7.69	R PRC.2250

6 metre lengths

PRD | PVC-U PREMIUM PRESSURE PIPE CLASS D

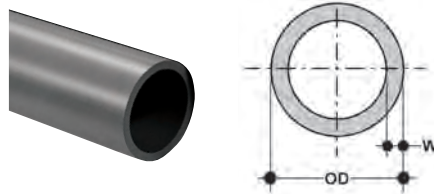

Size	OD mm	Min. Wall (w) mm	Weight kg/m	Code
1¼"	42.2	2.5	0.42	R PRD.0400
1½"	48.3	2.8	0.54	R PRD.0500
2"	60.3	3.4	0.84	R PRD.0630
3"	88.9	5.0	1.85	R PRD.0900
4"	114.3	6.5	3.12	R PRD.1100
5"	140.0	7.3	4.54	R PRD.1400
6"	168.3	9.5	6.97	R PRD.1600
8"	218.8	11.1	9.98	R PRD.2250

6 metre lengths

PRE | PVC-U PREMIUM PRESSURE PIPE CLASS E

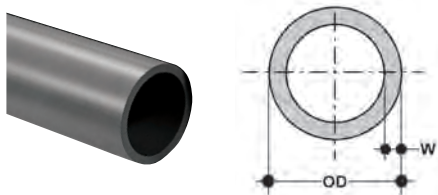

Size	OD mm	Min. Wall (w) mm	Weight kg/m	Code
½"	21.4	1.9	0.16	R PRE.0200
¾"	26.7	2.2	0.23	R PRE.0250
1"	33.6	2.5	0.32	R PRE.0320
1¼"	42.2	3.0	0.52	R PRE.0400
1½"	48.3	3.4	0.67	R PRE.0500
2"	60.3	4.2	1.00	R PRE.0630
3"	88.9	6.2	2.13	R PRE.0900
4"	114.3	7.9	3.73	R PRE.1100
6"	168.3	11.7	8.02	R PRE.1600

6 metre lengths

PR7 | PVC-U PREMIUM PRESSURE PIPE CLASS 7

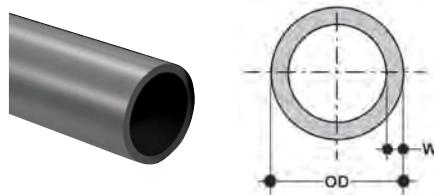

Size	OD mm	Min. Wall (w) mm	Weight kg/m	Code
½"	21.4	4.0	0.31	R PR7.0200
¾"	26.7	4.2	0.43	R PR7.0250
1"	33.6	4.8	0.62	R PR7.0320
1¼"	42.2	5.2	0.85	R PR7.0400
1½"	48.3	5.5	1.4	R PR7.0500
2"	60.3	5.9	1.43	R PR7.0630

6 metre lengths

> OPTIMA PVC-U PIPES

OPTIMA PVC-U PIPE

MRC | OPTIMA PIPE PVC-U CLASS C

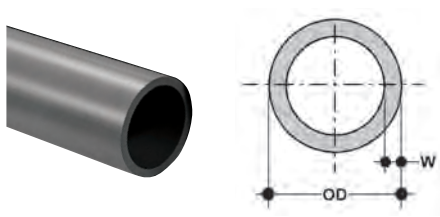

Size	OD mm	Min. Wall (w) mm	Weight kg/m	Code
2"	60.3	2.8	0.73	R MRC.0630
3"	88.9	3.8	1.05	R MRC.0900
4"	114.3	4.9	2.43	R MRC.1100
5"	140.0	5.9	3.49	R MRC.1400
6"	168.0	7.1	4.89	R MRC.1600

6 metre lengths

MRE | OPTIMA PIPE PVC-U CLASS E

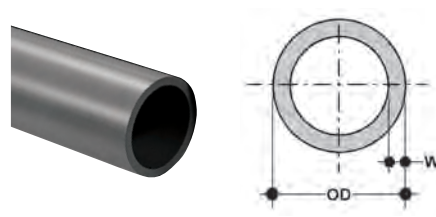

Size	OD mm	Min. Wall (w) mm	Weight kg/m	Code
1/2"	21.4	1.9	0.16	R MRE.0200
3/4"	26.7	2.2	0.23	R MRE.0250
1"	33.6	2.5	0.32	R MRE.0320
1 1/4"	42.2	3.0	0.52	R MRE.0400
1 1/2"	48.3	3.4	0.67	R MRE.0500
2"	60.3	4.2	1.00	R MRE.0630
3"	88.9	6.2	2.13	R MRE.0900
4"	114.3	7.9	3.73	R MRE.1100
6"	168.3	11.7	8.02	R MRE.1600
10"	273.1	15.1	11.90	R MRE.2800
12"	323.8	17.4	16.80	R MRE.3150

*Note - 10" & 12" pipe conforms to SCHEDULE80 specification

>ABS PIPE

PAC | ABS PRESSURE PIPE CLASS C

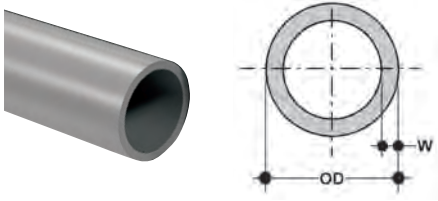

Size	OD mm	Min. Wall (w) mm	Weight kg/m	Code
1"	33.6	2.0	0.21	S PAC.0320
1¼"	42.2	2.5	0.32	S PAC.0400
1½"	48.3	2.8	0.42	S PAC.0500
2"	60.3	3.6	0.67	S PAC.0630
2½"	75.2	5.0	1.14	S PAC.0750
3"	88.9	5.2	1.40	S PAC.0900
4"	114.3	6.6	2.32	S PAC.1100
5"	140.2	9.3	3.97	S PAC.1400
6"	168.3	9.9	5.12	S PAC.1600
8"	219.1	12.7	8.57	S PAC.2250

6 metre lengths

PAD | ABS PRESSURE PIPE CLASS D

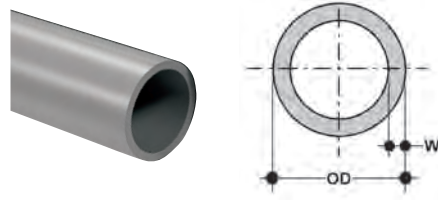

Size	OD mm	Min. Wall (w) mm	Weight kg/m	Code
6"	168.3	12.8	6.50	S PAD.1600

6 metre lengths

PAE | ABS PRESSURE PIPE CLASS E

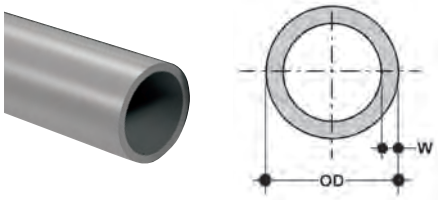

Size	OD mm	Min. Wall (w) mm	Weight kg/m	Code
½"	21.4	2.0	0.13	S PAE.0200
¾"	26.7	2.5	0.20	S PAE.0250
1"	33.6	3.1	0.31	S PAE.0320
1¼"	42.2	3.9	0.49	S PAE.0400
1½"	48.3	4.5	0.64	S PAE.0500
2"	60.3	5.6	1.00	S PAE.0630
3"	88.9	8.3	2.16	S PAE.0900
4"	114.3	10.6	3.59	S PAE.1100

6 metre lengths

PAT | ABS PRESSURE PIPE CLASS T (FOR THREADING)

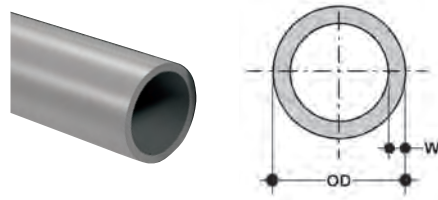

Size	OD mm	Min. Wall (w) mm	Weight kg/m	Code
½"	21.4	3.6	0.22	S PAT.0200
¾"	26.7	3.6	0.28	S PAT.0250
1"	33.6	4.3	0.43	S PAT.0320
1¼"	42.2	5.3	0.65	S PAT.0400
1½"	48.3	6.0	0.85	S PAT.0500
2"	60.3	7.2	1.28	S PAT.0630

6 metre lengths

> FITTINGS PLAIN

IMPERIAL ABS & PVC-U FITTINGS

MA4 | SOCKET PLAIN

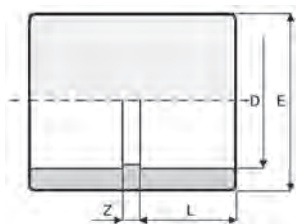
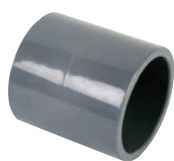

Size	L	Z	E	PVC-U		ABS	
				gms	Code	gms	Code
1/2"	16	3	28	15	R MA4.0200	11	S MA4.0200
3/4"	19	3	34	20	R MA4.0250	15	S MA4.0250
1"	22	3	42	30	R MA4.0320	23	S MA4.0320
1 1/4"	26	3	51	60	R MA4.0400	46	S MA4.0400
1 1/2"	31	3	61	85	R MA4.0500	65	S MA4.0500
2"	38	3	75	140	R MA4.0630	106	S MA4.0630
2 1/2"	44	4	89	215	R MA1.0750	163	S MA4.0750
3"	51	5	106	355	R MA4.0900	270	S MA4.0900
4"	61	6	129	605	R MA4.1100	460	S MA4.1100
5"	76	8	162	1230	R MA1.1400	935	S MA4.1400
6"	86	8	182	1380	R MA4.1600	1049	S MA4.1600
8"	115	12	195	4950	R MA4.2250	3668	S MA4.2250
MTO 10"	140	10	308	5800	R MA4.2800	-	-
MTO 12"	165	13	362	9800	R MA4.3150	-	-

G04 | ELBOW 90° PLAIN

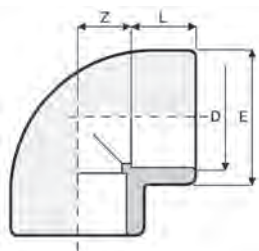

Size	L	Z	E	PVC-U		ABS	
				gms	Code	gms	Code
1/2"	16	11	28	25	R G04.0200	19	S G04.0200
3/4"	19	14	34	35	R G04.0250	27	S G04.0250
1"	22	17	42	35	R G04.0320	27	S G04.0320
1 1/4"	26	21	51	95	R G04.0400	72	S G04.0400
1 1/2"	31	26	61	145	R G04.0500	110	S G04.0500
2"	38	33	75	230	R G04.0630	175	S G04.0630
2 1/2"	44	39	89	385	R G01.0750	293	S G04.0750
3"	51	47	106	600	R G04.0900	456	S G04.0900
4"	61	57	129	1020	R G04.1100	775	S G04.1100
5"	76	72	163	2125	R G01.1400	1615	S G04.1400
6"	86	82	186	2920	R G04.1600	2219	S G04.1600
8"	115	116	257	8850	R G04.2250	6900	S G04.2250
MTO 10"	140	146	307	13300	R G04.2800	N/A	-
MTO 12"	165	175	363	20300	R G04.3150	N/A	-

GY4 | ELBOW 45° PLAIN

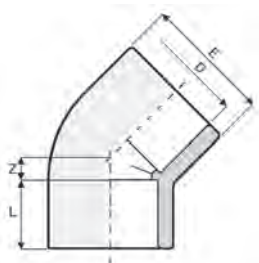

Size	L	Z	E	PVC-U		ABS	
				gms	Code	gms	Code
1/2"	16	5	28	20	R GY4.0200	15	S GY4.0200
3/4"	19	6	34	25	R GY4.0250	19	S GY4.0250
1"	22	8	42	45	R GY4.0320	34	S GY4.0320
1 1/4"	26	10	51	75	R GY4.0400	57	S GY4.0400
1 1/2"	31	12	61	110	R GY4.0500	84	S GY4.0500
2"	38	14	75	230	R GY4.0630	175	S GY4.0630
2 1/2"	44	17	89	300	R GY1.0750	228	S GY4.0750
3"	51	20	106	420	R GY4.0900	319	S GY4.0900
4"	61	24	129	835	R GY4.1100	635	S GY4.1100
5"	76	31	163	1620	R GY1.1400	1231	S GY4.1400
6"	86	35	186	2265	R GY4.1600	1721	S GY4.1600
8"	116	65	259	7250	R GY4.2250	5620	S GY4.2250
MTO 10"	140	66	307	9800	R GY4.2800	N/A	-
MTO 12"	165	78	363	15500	R GY4.3150	N/A	-

MTO = Made to Order (Please refer to our Terms & Conditions).

> FITTINGS PLAIN

IMPERIAL ABS & PVC-U FITTINGS

CU4 | BEND 90° PLAIN

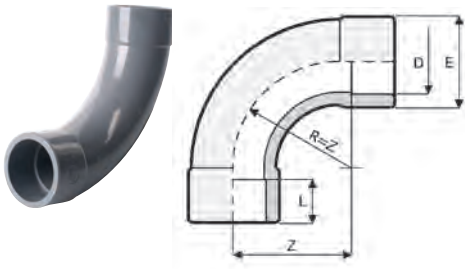

Size (D)	L	Z	E	PVC-U		ABS	
				gms	Code	gms	Code
1/2"	16	40	28	45	R CU4.0200	34	S CU4.0200
3/4"	19	50	34	75	R CU4.0250	57	S CU4.0250
1"	22	64	41	120	R CU4.0320	91	S CU4.0320
1 1/4"	26	80	51	205	R CU4.0400	156	S CU4.0400
1 1/2"	31	100	65	310	R CU4.0500	236	S CU4.0500
2"	38	126	77	510	R CU4.0630	388	S CU4.0630
2 1/2"	44	150	94	995	R CU1.0750	756	S CU4.0750
3"	51	180	113	1765	R CU4.0900	1341	S CU4.0900
4"	61	220	137	2805	R CU4.1100	2132	S CU4.1100

LU4 | BEND LONG RADIUS 90 DEGREE

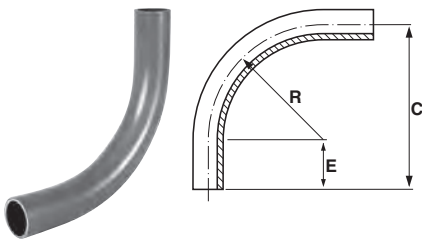

Size	C	R	E	PVC-U		ABS	
				gms	Code	gms	Code
MTO 3"	403	305	98	1510	R LU4.0900	1535	S LU4.0900
MTO 4"	545	407	138	3550	R LU4.1100	3440	S LU4.1100
MTO 6"	817	610	207	11000	R LU4.1600	9430	S LU4.1600

LY4 | BEND LONG RADIUS 45 DEGREE

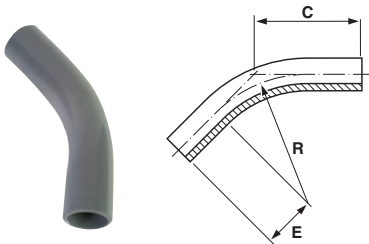

Size	C	R	E	PVC-U		ABS	
				gms	Code	gms	Code
MTO 1 1/2"	113	152	55	204	R LY4.0500	156	S LY4.0500
MTO 2"	152	203	73	316	R LY4.0630	322	S LY4.0630
MTO 3"	238	305	121	1080	R LY4.0900	1100	S LY4.0900
MTO 4"	300	407	145	2235	R LY4.1100	2290	S LY4.1100

LT4 | BEND LONG RADIUS 22 1/2 DEGREE

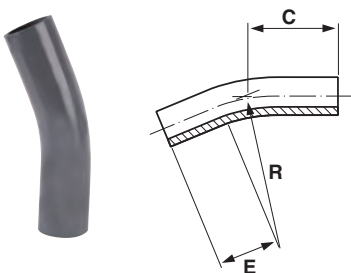

Size	C	R	E	PVC-U		ABS	
				gms	Code	gms	Code
MTO 1 1/2"	110	152	57	148	R LT4.0500	143	S LT4.0500
MTO 2"	113	203	73	285	R LT4.0630	274	S LT4.0630
MTO 3"	202	305	114	858	R LT4.0900	857	S LT4.0900
MTO 4"	262	407	152	1804	R LT4.1100	1886	S LT4.1100
MTO 6"	385	610	229	5993	R LT4.1600	5154	S LT4.1600

MTO = Made to Order (Please refer to our Terms & Conditions).

> FITTINGS PLAIN

IMPERIAL ABS & PVC-U FITTINGS

MA5 | IMPERIAL/METRIC SOCKET PLAIN

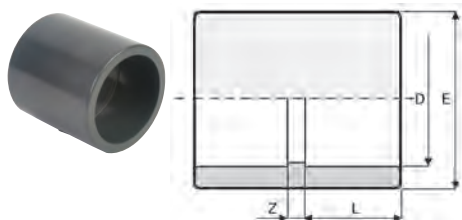

Size (D)	L	Z	E	PVC-U		ABS	
				gms	Code	gms	Code
1/2" x 20	16	2.5	27	12	R MA5.0200	7	S MA5.0200
3/4" x 25	19	2.5	33	22	R MA5.0250	12	S MA5.0250
1" x 32	22	2.5	41	44	R MA5.0320	25	S MA5.0320
1 1/4" x 40	26	2	50	65	R MA5.0400	45	S MA5.0400
1 1/2" x 50	31	4	61	125	R MA5.0500	62	S MA5.0500
2" x 63	38	5	76	210	R MA5.0630	114	S MA5.0630
3" x 90	51	5.5	108	438	R MA5.0900	355	S MA5.0900
4" x 110	61	4	132	852	R MA5.1100	690	S MA5.1100

TI4 | TEE 90° PLAIN

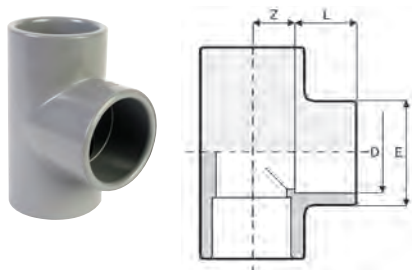

Size (D)	L	Z	E	PVC-U		ABS	
				gms	Code	gms	Code
1/2"	16	11	28	35	R TI4.0200	27	STI4.0200
3/4"	19	14	34	50	R TI4.0250	38	S TI4.0250
1"	22	17	42	70	R TI4.0320	53	S TI4.0320
1 1/4"	26	21	51	120	R TI4.0400	91	S TI4.0400
1 1/2"	31	26	61	185	R TI4.0500	141	S TI4.0500
2"	38	33	75	305	R TI4.0630	232	S TI4.0630
2 1/2"	44	39	89	505	R TI1.0750	384	S TI4.0750
3"	51	47	106	795	R TI4.0900	604	S TI4.0900
4"	61	57	129	1415	R TI4.1100	1075	S TI4.1100
5"	76	72	163	2740	R TI1.1400	2082	S TI4.1400
6"	86	82	186	3855	R TI4.1600	2930	S TI4.1600
8"	115	116	257	10500	R TI4.2250	9600	S TI4.2250
MTO 10"	139	148	306	18600	R TI4.2800	N/A	-
MTO 12"	165	175	363	27200	R TI4.3150	N/A	-

B04 | UNION PLAIN (EPDM)

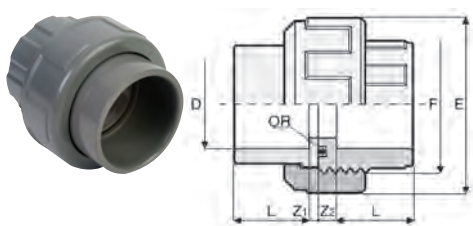

Size (D)	L	Z ₁	Z ₂	F	E	PVC-U		ABS	
						gms	Code	gms	Code
1/2"	16	3	10	1"	42	42	R B04.0200	32	S B04.0200
3/4"	19	3	10	1/4"	52	70	R B04.0250	53	S B04.0250
1"	22	3	10	1/2"	59	97	R B04.0320	74	S B04.0320
1 1/4"	26	3	12	2"	72	156	R B04.0400	119	S B04.0400
1 1/2"	31	3	14	3/4"	79	216	R B04.0500	164	S B04.0500
2"	38	3	18	3/4"	96	368	R B04.0630	280	S B04.0630
2 1/2"	44	3	20	1/2"	116.6	560	R B01.0750	426	S B04.0750
3"	51	5	20	4"	131	750	R B04.0900	570	S B04.0900
4"	61	5	20	5"	159.4	1300	R B04.1100	988	S B04.1100

Note: FPM seals available upon request.

MTO = Made to Order (Please refer to our Terms & Conditions).

> FITTINGS PLAIN

IMPERIAL ABS & PVC-U FITTINGS

CA4 | CAP PLAIN

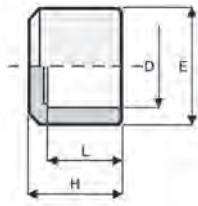
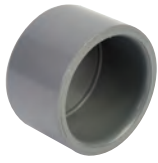

FIG A

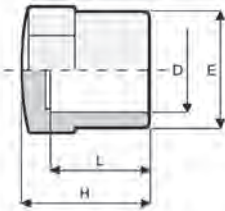

FIG B

Size (D)	L	H	E	Fig.	PVC-U		ABS	
					gms	Code	gms	Code
1/2"	16	24	28	A	49	R CA4.0200	37	S CA4.0200
3/4"	19	27	34	A	49	R CA4.0250	37	S CA4.0250
1"	22	30	42	A	33	R CA4.0320	25	S CA4.0320
1 1/4"	26	35	51	A	50	R CA4.0400	38	S CA4.0400
1 1/2"	31	40	61	A	70	R CA4.0500	53	S CA4.0500
2"	38	48	75	A	115	R CA4.0630	87	S CA4.0630
2 1/2"	44	59	89	B	228	R CA1.0750	173	S CA4.0750
3"	51	67	106	B	349	R CA4.0900	265	S CA4.0900
4"	61	77	129	B	530	R CA4.1100	403	S CA4.1100
5"	76	108	162	A	860	R CA1.1400	654	-
6"	86	126	181	A	1317	R CA4.1600	990	-

RC4 | REDUCING BUSH PLAIN

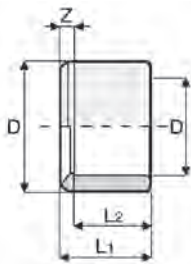
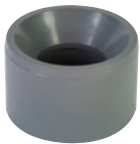

FIG A

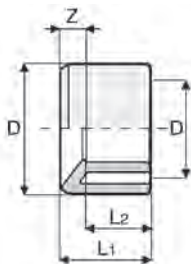

FIG B

Size (DxD)	L ₁	L ₂	Z	Fig.	PVC-U		ABS	
					gms	Code	gms	Code
3/4 x 1/2"	19.5	16.5	3	A	5.5	R RC4.025B	4	S RC4.025B
1 x 1/2"	22.5	16	6.5	A	18	R RC4.032B	14	S RC4.032B
1 x 3/4"	22.5	19.5	3	A	10	R RC4.032C	8	S RC4.032C
1 1/4 x 1"	27	23	4	A	15	R RC4.040D	11	S RC4.040D
1 1/2 x 3/4"	30	20	10	B	45	R RC4.050C	34	S RC4.050C
1 1/2 x 1"	30	22.5	7.5	A	44	R RC4.050D	33	S RC4.050D
1 1/2 x 1 1/4"	31	27	4	A	35	R RC4.050E	27	S RC4.050E
2 x 1"	36	29	7	A	80	R RC4.063D	61	S RC4.063D
2 x 1 1/4"	38	26	12	B	80	R RC4.063E	61	S RC4.063E
2 x 1 1/2"	38	32	7	B	65	R RC4.063F	49	S RC4.063F
2 1/2 x 2"	43.5	36	7.5	A	85	R RC4.075G	65	S RC4.075G
3 x 1 1/2"	50.5	30	20.5	B	220	R RC4.090F	167	S RC4.090F
3 x 2"	51	38	13	B	205	R RC4.090G	156	S RC4.090G
3 x 2 1/2"	50.5	43.5	7	A	150	R RC4.090H	114	S RC4.090H
4 x 2"	63	36	27	B	375	R RC4.110G	285	S RC4.110G
4 x 3"	63	51	12	A	280	R RC4.110I	213	S RC4.110I
5 x 4"	76	61	15	B	460	R RC4.140L	350	S RC4.140L
6 x 4"	90	63	27	B	795	R RC4.160L	604	S RC4.160L
8 x 6"	115.5	90	25.5	A	1400	R RC4.2250	1185	S RC4.2250
MTO 10 x 8"	140	115	25	A	3500	R RC4.280R	N/A	-
MTO 12 x 10"	165	140	25	A	4100	R RC4.315S	N/A	-

MTO = Made to Order (Please refer to our Terms & Conditions).

> FITTINGS PLAIN/THREADED

IMPERIAL ABS & PVC-U FITTINGS

MA6 | SOCKET PLAIN/THREADED

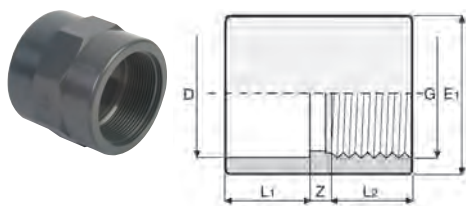

Size (DxG)	L ₁	L ₂	Z	E ₁	PVC-U		ABS	
					gms	Code	gms	Code
1/2" x 1/2"	16	15	4	27	15	R MA6.0200	11	S MA6.0200
3/4" x 3/4"	19.5	16.3	5.2	33	25	R MA6.0250	19	S MA6.0250
1" x 1"	22.5	19.1	4.5	41	45	R MA6.0320	30	S MA6.0320
1 1/4" x 1 1/4"	27	21.4	4	50	65	R MA6.0400	46	S MA6.0400
1 1/2" x 1 1/2"	30	21.4	8	61	100	R MA6.0500	76	S MA6.0500
2" x 2"	36	25.7	9	76	160	R MA6.0630	137	S MA6.0630
2 1/2" x 2 1/2"	44	30.2	17.8	90	260	R MA3.075H	-	-
3" x 3"	51	33	22.7	108	449	R MA6.0900	-	-
4" x 4"	61	39	10	129	555	R MA6.1100	-	-

G06 | ELBOW 90° PLAIN/THREADED

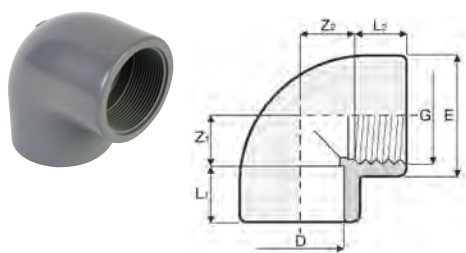

Size (DxG)	L ₁	L ₂	Z ₁	Z ₂	E	PVC-U		ABS	
						gms	Code	gms	Code
1/2" x 1/2"	16.5	15	10.5	12	27	13	R G06.0200	19	S G06.0200
3/4" x 3/4"	19.5	16.3	13.5	16.7	33	25	R G06.0250	29	S G06.0250
1" x 1"	22.5	19.1	17	20.4	41	55	R G06.0320	46	S G06.0320
1 1/4" x 1 1/4"	27	21.5	21.5	27	54	120	R G06.0400	72	S G06.0400
1 1/2" x 1 1/2"	31	21.4	27	36.6	61	170	R G06.0500	125	S G06.0500
2" x 2"	38	25.7	33.5	45.8	76	340	R G06.0630	213	S G06.0630
2 1/2" x 2 1/2"	44	30.3	40.5	54.3	90	420	R G03.075H	-	-
3" x 3"	51	33.3	48	65.7	108	750	R G06.0900	-	-

T16 | TEE PLAIN/THREADED BRANCH

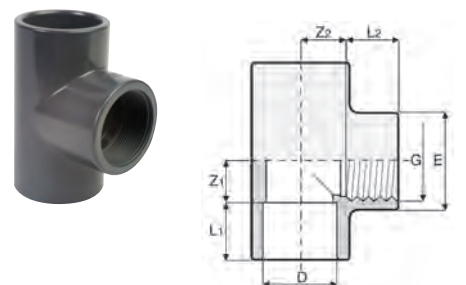

Size (DxG)	L ₁	L ₂	Z ₁	Z ₂	E	PVC-U	
						gms	Code
1/2" x 1/2"	16	15	11	12	28	49	R T16.0200
3/4" x 3/4"	19	16	14	16	34	55	R T16.0250
1" x 1"	22	19	17	20	42	75	R T16.0320
1 1/4" x 1 1/4"	26	21	21	25	51	125	R T16.0400
1 1/2" x 1 1/2"	31	21	26	35	61	200	R T16.0500
3" x 3"	38	25	33	45	75	380	R T16.0630

RC6 | REDUCING BUSH PLAIN/THREADED

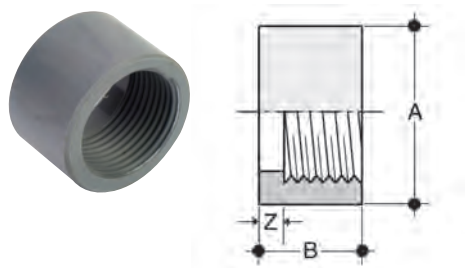

Size	B	Z	A	PVC-U		ABS	
				gms	Code	gms	Code
1/2" x 3/8"	16	6	21.4	5	R RC6.020A	4	S RC6.020A
3/4" x 1/2"	20	5	26.5	9	R RC6.025B	7	S RC6.025B
1" x 3/4"	25	6	33.6	15	R RC6.032C	12	S RC6.032C

MTO = Made to Order (Please refer to our Terms & Conditions).

> FITTINGS PLAIN/THREADED

IMPERIAL ABS & PVC-U FITTINGS

AF6 | ADAPTOR MALE PLAIN/FEMALE THREADED

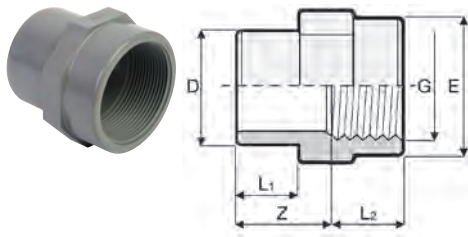

Size (DxG)	L ₁	L ₂	E	Z	PVC-U		ABS	
					gms	Code	gms	Code
1/2" x 1/2"	16	15.0	28	22	20	R AF6.0200	15	S AF6.0200
3/4" x 3/4"	19	16.3	34	29	30	R AF6.0250	23	S AF6.0250
1" x 1"	22	19.1	42	32	40	R AF6.0320	30	S AF6.0320
1 1/4" x 1 1/4"	26	21.4	51	37	76	R AF6.0400	58	S AF6.0400
1 1/2" x 1 1/2"	31	21.4	58	42	100	R AF6.0500	76	S AF6.0500
2" x 2"	38	25.7	72	50	140	R AF6.0630	106	S AF6.0630

AM6 | ADAPTOR FEMALE PLAIN/MALE THREADED

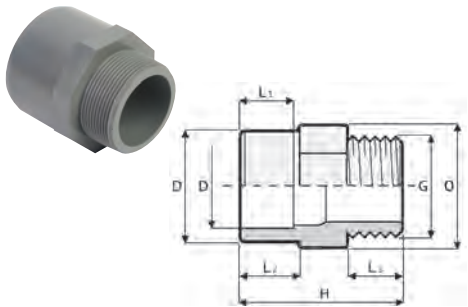

Size (DxDxG)	L ₁	L ₂	L ₃	H	O	PVC-U		ABS	
						gms	Code	gms	Code
1/2" x 3/4" x 1/2"	16	19	15.0	46	30	15	R AM6.0200	11	S AM6.0200
3/4" x 1" x 3/4"	19	22	16.3	50	36	25	R AM6.0250	19	S AM6.0250
1" x 3/4" x 1"	22	26	19.1	57	46	40	R AM6.0320	30	S AM6.0320
1 1/4" x 1" x 1 1/4"	26	31	21.4	67	55	70	R AM6.0400	53	S AM6.0400
1 1/2" x 1 1/4" x 1 1/2"	31	38	21.4	74	65	115	R AM6.0500	87	S AM6.0500
2" x 1 1/2" x 2"	38	44	25.7	84	80	160	R AM6.0630	122	S AM6.0630
2 1/2" x 2" x 2 1/2"	44	51	30.2	99	95	285	R AM3.075H	-	-
3" x 2 1/2" x 3"	51	61	33.3	113	115	490	R AM6.0900	-	-
4" x 3" x 4"	61	68	39.3	120	130	490	R AM6.1100	-	-

TC6 | TANK CONNECTOR PLAIN/THREADED

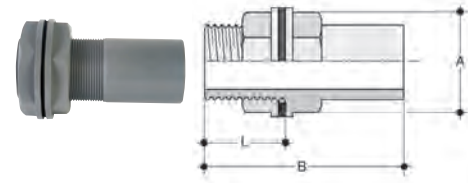

Size (D)	L	B	A	PVC-U		ABS	
				gms	Code	gms	Code
1/2"	42	76	28	34	R TC6.0200	26	S TC6.0200
3/4"	42	76	33	39	R TC6.0250	30	S TC6.0250
1"	55	101	46	110	R TC6.0320	80	S TC6.0320
1 1/4"	70	120	5	154	R TC6.0400	120	S TC6.0400
1 1/2"	73	127	60	207	R TC6.0500	170	S TC6.0500
2"	85	152	79	358	R TC6.0630	325	S TC6.0630
2 1/2"	94	164	90	471	R TC6.0750	430	S TC6.0750
3"	112	202	105	656	R TC6.0900	700	S TC6.0900
4"	130	230	135	1345	R TC6.1100	1225	S TC6.1100

BO6 | UNION PLAIN/THREADED (EPDM)

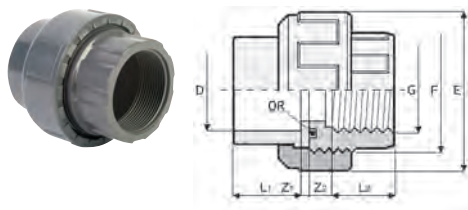

Size (DxG)	L ₁	L ₂	Z ₁	Z ₂	F	E	PVC-U	
							gms	Code
1/2" x 1/2"	16	15	3	11.0	1"	42	42	R BO6.0200
3/4" x 3/4"	19	16	3	12.7	1 1/4"	52	70	R BO6.0250
1" x 1"	22	19	3	12.9	1 1/2"	59	96	R BO6.0320
1 1/4" x 1 1/4"	26	21	3	16.6	2"	72	155	R BO6.0400
1 1/2" x 1 1/2"	31	21	3	23.6	2 1/4"	79	237	R BO6.0500
2" x 2"	38	25	3	30.3	2 3/4"	96	405	R BO6.0630

Note: FPM seals available upon request.

BN6 | BARREL NIPPLE PLAIN/THREADED

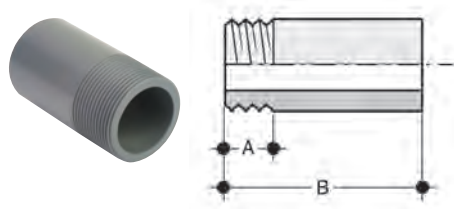

Size	A	B	PVC-U		ABS	
			gms	Code	gms	Code
3/8"	13	42	10	R BN6.0160	-	-
1/2"	16	49	15	R BN6.0200	10	S BN6.0200
3/4"	18	55	20	R BN6.0250	15	S BN6.0250
1"	21	62	35	R BN6.0320	25	S BN6.0320
1 1/4"	23	72	60	R BN6.0400	45	S BN6.0400
1 1/2"	30	87	45	R BN6.0500	70	S BN6.0500
2"	30	87	115	R BN6.0630	105	S BN6.0630
2 1/2"	35	106	180	R BN6.0750	120	S BN6.0750
3"	38	127	300	R BN6.0900	252	S BN6.0900
4"	40	150	560	R BN6.1100	525	S BN6.1100

PO3 | HOSE ADAPTOR BSP THREADED/METRIC

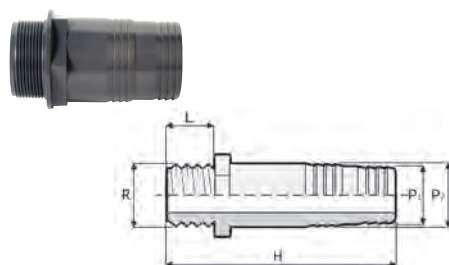

Size (R x P ₁ x P ₂)	L	H	gms	PVC-U
3/8" x 16 x 18	11.4	58	14	R PO3.016A
1/2" x 20 x 22	15	66	19	R PO3.020B
3/4" x 25 x 27	16.3	81	30	R PO3.025C
1" x 30 x 32	19.1	97	45	R PO3.032D
1 1/4" x 40 x 42	21.4	104	85	R PO3.040E
1 1/2" x 50 x 52	21.4	111	120	R PO3.050F
2" x 60 x 64	25.7	123	180	R PO3.063G

FB6 | COMPOSITE UNIONS PLAIN / BSP THREADED FEMALE BRASS

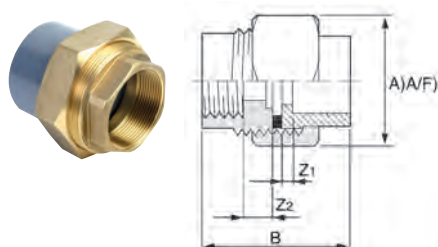

Size	PN	A	B	Z ₁	Z ₂	PVC-U		ABS	
						gms	Code	gms	Code
1/2"	15	40	42	3	7	165	R FB6.0200	165	S FB6.0200
3/4"	15	48	49	3	9	290	R FB6.0250	290	S FB6.0250
1"	15	55	59	11	12	310	R FB6.0320	310	S FB6.0320
1 1/4"	15	65	68	9	10	450	R FB6.0400	450	S FB6.0400
1 1/2"	15	79	75	12	14	800	R FB6.0500	800	S FB6.0500
2"	15	88	90	14	14	950	R FB6.0630	950	S FB6.0630

MB6 | COMPOSITE UNIONS PLAIN / BSP THREADED MALE BRASS

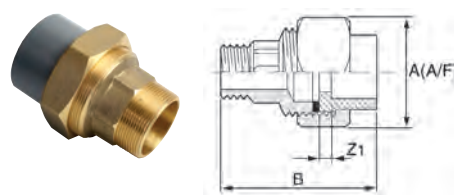

Size	PN	A	B	Z ₁	PVC-U		ABS	
					gms	Code	gms	Code
1/2"	15	40	54	3	175	R MB6.0200	175	S MB6.0200
3/4"	15	48	74	3	320	R MB6.0250	320	S MB6.0250
1"	15	55	86	8	420	R MB6.0320	420	S MB6.0320
1 1/4"	15	65	94	10	620	R MB6.0400	620	S MB6.0400
1 1/2"	15	78	108	13	1000	R MB6.0500	1000	S MB6.0500
2"	15	88	129	15	1200	R MB6.0630	1200	S MB6.0630

> FITTINGS THREADED

IMPERIAL ABS & PVC-U FITTINGS

MA2 | SOCKET THREADED

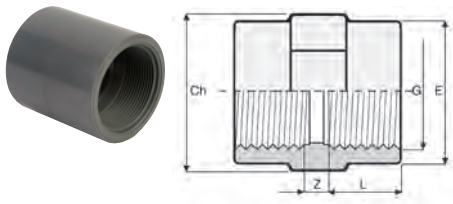

Size (G)	L	Z	E	Ch	PVC-U	
					gms	Code
3/8"	11.4	6	23	24	9	R MA2.0160
1/2"	15	7	28	29	20	R MA2.0200
3/4"	16.3	7	34	35	30	R MA2.0250
1"	19.1	8	42	43	50	R MA2.0320
1 1/4"	21.4	8	51	55	65	R MA2.0400
1 1/2"	21.4	8	58	65	100	R MA2.0500
2"	25.7	8	72	75	135	R MA2.0630
2 1/2"	30.2	9	89	90	215	R MA2.0750
3"	33.3	10	103	105	305	R MA2.0900
4"	39.3	11	130	130	652	R MA2.1100

G02 | ELBOW 90° THREADED

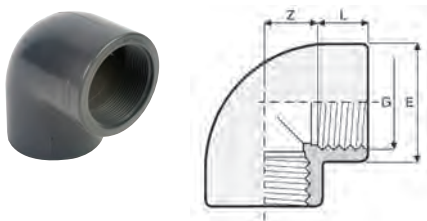

Size (G)	L	Z	E	PVC-U	
				gms	Code
3/8"	11.4	11.6	23	27	R G02.0160
1/2"	15	13	28	25	R G02.0200
3/4"	16.3	16.7	35	40	R G02.0250
1"	19.1	19.9	43	65	R G02.0320
1 1/4"	21.4	25.6	51	100	R G02.0400
1 1/2"	21.4	35.6	61	190	R G02.0500
2"	25.7	45.3	76	340	R G02.0630
2 1/2"	30.2	52.8	89	455	R G02.0750
3"	33.3	64.7	106	545	R G02.0900
4"	39.3	78.7	129	1030	R G02.1100

T12 | TEE 90°

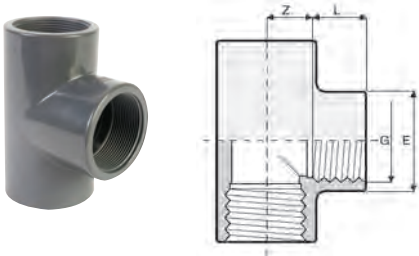

Size (G)	L	Z	E	PVC-U	
				gms	Code
3/8"	11.4	11.6	23	37	R T12.0160
1/2"	15	13	28	30	R T12.0200
3/4"	16.3	16.7	35	55	R T12.0250
1"	19.1	19.9	43	80	R T12.0320
1 1/4"	21.4	25.6	51	132	R T12.0400
1 1/2"	21.4	35.6	61	255	R T12.0500
2"	25.7	45.3	75	450	R T12.0630
2 1/2"	30.2	52.8	89	595	R T12.0750
3"	33.3	64.7	106	1040	R T12.0900
4"	39.3	78.7	129	1415	R T12.1100

TA2 | PLUG THREADED

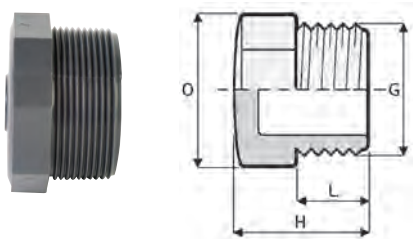

Size (G)	L	H	O	PVC-U	
				gms	Code
3/8"	11.4	24	22	5	R TA2.0160
1/2"	15	29	24	10	R TA2.0200
3/4"	16.3	30	30	15	R TA2.0250
1"	19.1	33	36	25	R TA2.0320
1 1/4"	21.4	39	46	50	R TA2.0400
1 1/2"	21.4	39	50	35	R TA2.0500
2"	25.7	43	65	80	R TA2.0630
2 1/2"	30.2	51	80	160	R TA2.0750
3"	33.3	55	95	235	R TA2.0900
4"	39.3	61	120	360	R TA2.1100

> FITTINGS THREADED

IMPERIAL ABS & PVC-U FITTINGS

NI2 | HEXAGON NIPPLE THREADED

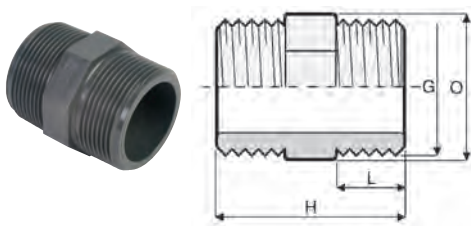

Size (G)	L	H	O	PVC-U	
				gms	Code
3/8"	11.4	33	22	5	R NI2.0160
1/2"	15	42	24	10	R NI2.0200
3/4"	16.3	44	30	20	R NI2.0250
1"	19.1	50	36	30	R NI2.0320
1 1/4"	21.4	58	46	45	R NI2.0400
1 1/2"	21.4	58	50	63	R NI2.0500
2"	25.7	66	65	105	R NI2.0630
2 1/2"	30.2	78	80	175	R NI2.0750
3"	33.3	85	95	245	R NI2.0900
4"	39.3	96	120	348	R NI2.1100

NR2 | REDUCING NIPPLE THREADED

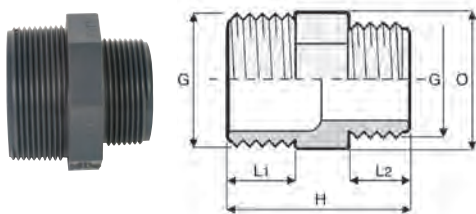

Size (GxG)	L1	L2	H	O	PVC-U	
					gms	Code
1/2" x 3/8"	15	11.4	38	24	14	R NR2.020A
3/4" x 1/2"	16.3	15	43	30	15	R NR2.025B
1" x 3/4"	19.1	16.3	47	36	25	R NR2.032C
1 1/4" x 1"	21.4	19.1	56	46	40	R NR2.040D
1 1/2" x 1 1/4"	21.4	21.4	58	50	60	R NR2.050E
2" x 1 1/2"	25.7	21.4	62	65	90	R NR2.063F
2 1/2" x 2"	30.2	25.7	72	80	155	R NR2.075G
3" x 2 1/2"	33.3	30.2	82	95	240	R NR2.090H
4" x 3"	39.3	33.3	90	120	357	R NR2.110I

MG2 | REDUCING PIECE FEMALE THREADED/MALE THREADED

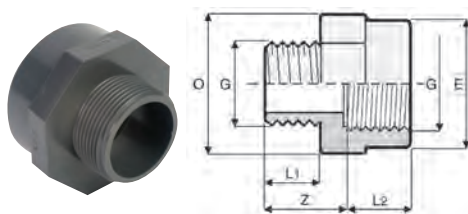

Size (GxG)	L1	L2	Z	O	E	PVC-U	
						gms	Code
3/8" x 1/2"	11.4	15	22	30	28	27	R MG2.016B
1/2" x 3/4"	15	16.3	24	36	34	15	R MG2.020C
3/4" x 1"	16.3	19.1	26	46	42	40	R MG2.025D
1" x 1 1/4"	19.1	21.4	30	55	51	72	R MG2.032E
1 1/4" x 1 1/2"	21.4	21.4	33	60	58	83	R MG2.040F
1 1/2" x 2"	21.4	25.7	34	75	72	125	R MG2.050G
2 1/2" x 2"	25.7	30.2	38	90	89	202	R MG2.063H
2 1/2" x 3"	30.2	33.3	44	105	103	240	R MG2.075I
3" x 4"	33.3	39.3	48	130	130	333	R MG2.090L

MR2 | REDUCING PIECE FEMALE THREADED

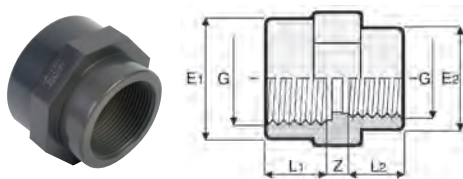

Size (GxG)	L1	L2	Z	E1	E2	PVC-U	
						gms	Code
1/2" x 3/8"	15	11.4	6	28	23	7	R MR2.020A
3/4" x 1/2"	16.3	15	7	34	28	25	R MR2.025B
1" x 3/4"	19.1	16.3	7	42	34	40	R MR2.032C
1 1/4" x 1"	21.4	19.1	8	51	42	34	R MR2.040D
1 1/2" x 1 1/4"	21.4	21.4	8	58	51	79	R MR2.050E
2" x 1 1/2"	25.7	21.4	8	72	58	130	R MR2.063F
2 1/2" x 2"	30.2	25.7	8	89	72	178	R MR2.075G
3" x 2 1/2"	33.3	30.2	9	103	89	226	R MR2.090H
4" x 3"	39.3	33.3	10	130	103	515	R MR2.110I

> FITTINGS THREADED

IMPERIAL ABS & PVC-U FITTINGS

CA2 | END CAP THREADED

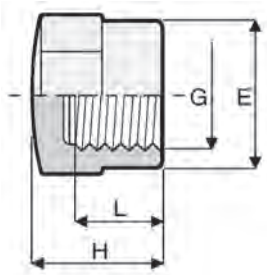
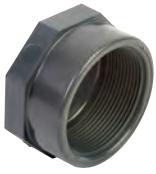

Size (G)	L	H	E	PVC-U	
				gms	Code
3/8"	11.4	22	23	37	R CA2.0160
1/2"	15	24	28	20	R CA2.0200
3/4"	16.3	27	34	25	R CA2.0250
1"	19.1	30	42	40	R CA2.0320
1 1/4"	21.4	35	51	60	R CA2.0400
1 1/2"	21.4	40	61	85	R CA2.0500
2"	25.7	48	75	115	R CA2.0630
2 1/2"	30.2	50	89	251	R CA2.0750
3"	33.3	53	103	390	R CA2.0900
4"	39.3	59	130	623	R CA2.1100

B02 | UNION THREADED (EPDM)

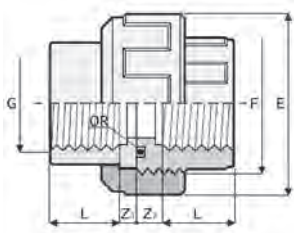

Size (G)	L	Z ₁	Z ₂	F	E	O-R	PN	PVC-U	
								gms	Code
3/8"	11.4	5.6	13.6	3/4"	34	3062	32	16	R B02.0160
1/2"	15	4	11	1"	42	4081	44	16	R B02.0200
3/4"	16.3	5.7	12.7	1 1/4"	52	4112	72	16	R B02.0250
1"	19.1	5.9	12.9	1 1/2"	59	4125	100	16	R B02.0320
1 1/4"	21.4	7.6	16.6	2"	72	6162	161	16	R B02.0400
1 1/2"	21.4	12.6	23.6	2 1/4"	79	6187	264	16	R B02.0500
2"	25.7	15.3	30.3	2 3/4"	96	6237	454	16	R B02.0630
2 1/2"	30.2	17.8	32.8	3 1/2"	119	6312	560	10	R B02.0750
3"	33.3	25.7	36.7	4"	134	6362	750	6	R B02.0900
4"	39.3	27.7	40.7	5"	163	6450	1300	6	R B02.1100

Note: FPM seals available on request

NU2 | BACK NUT THREADED

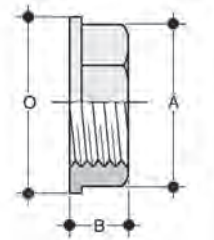

Size	A	B	O	PVC-U		ABS	
				gms	Code	gms	Code
1/2"	29	13	37	10	R NU2.0200	10	S NU2.0200
3/4"	33	14	43	10	R NU2.0250	10	S NU2.0250
1"	46	16	56	25	R NU2.0320	20	S NU2.0320
1 1/4"	50	18	59	30	R NU2.0400	20	S NU2.0400
1 1/2"	60	19	70	40	R NU2.0500	30	S NU2.0500
2"	79	21	92	80	R NU2.0630	65	S NU2.0630
2 1/2"	95	23	105	105	R NU2.0750	85	S NU2.0750
3"	110	27	125	165	R NU2.0900	130	S NU2.0900
4"	139	30	152	260	R NU2.1100	205	S NU2.1100

BA2 | BARREL NIPPLE THREADED/THREADED

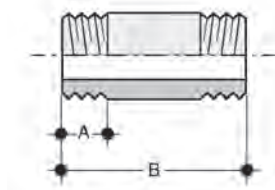

Size	A	B	PVC-U		ABS	
			gms	Code	gms	Code
3/8"	11	33	5	R BA2.0160	-	-
1/2"	16	49	15	R BA2.0200	10	S BA2.0200
3/4"	18	55	20	R BA2.0250	15	S BA2.0250
1"	21	62	35	R BA2.0320	25	S BA2.0320
1 1/4"	23	72	55	R BA2.0400	40	S BA2.0400
1 1/2"	30	87	75	R BA2.0500	60	S BA2.0500
2"	30	87	105	R BA2.0630	95	S BA2.0630
2 1/2"	30	105	169	R BA2.0750	157	S BA2.0750
3"	38	127	250	R BA2.0900	245	S BA2.0900
4"	40	150	500	R BA2.1100	490	S BA2.1100

RI2 | REDUCING PIECE MALE THREADED/FEMALE THREADED

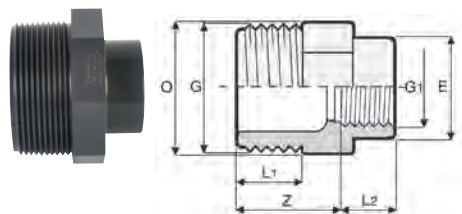

Size (GxG ¹)	L ₁	L ₂	Z	E	O	PVC-U	
						gms	Code
1/2" x 3/8"	15	11.4	24	23	24	21	R RI2.020A
3/4" x 1/2"	16.3	15	26	28	30	20	R RI2.025B
1" x 1/2"	19.1	15	29	28	36	25	R RI2.032B
1" x 3/4"	19.1	16.3	30	34	36	30	R RI2.032C
1 1/4" x 1/2"	21.4	15	33	28	46	41	R RI2.040B
1 1/4" x 3/4"	21.4	16.3	33	34	46	45	R RI2.040C
1 1/4" x 1"	21.4	19.1	33	42	46	50	R RI2.040D
1 1/2" x 3/4"	21.4	16.3	34	34	50	50	R RI2.050C
1 1/2" x 1"	21.4	19.1	34	42	50	54	R RI2.050D
1 1/2" x 1 1/4"	21.4	21.4	34	51	55	79	R RI2.050E
2" x 1"	25.7	19.1	37	42	65	95	R RI2.063D
2" x 1 1/4"	25.7	21.4	37	51	65	10	R RI2.063E
2" x 1 1/2"	25.7	21.4	37	58	65	105	R RI2.063F
2 1/2" x 1 1/4"	30.2	21.4	43	51	80	140	R RI2.075E
2 1/2" x 1 1/2"	30.2	21.4	43	58	80	145	R RI2.075F
2 1/2" x 2"	30.2	25.7	43	72	80	160	R RI2.075G
3" x 1 1/2"	33.3	21.4	47	58	95	199	R RI2.090F
3" x 2"	33.3	25.7	47	72	95	215	R RI2.090G
3" x 2 1/2"	33.3	30.2	47	89	95	230	R RI2.090H
4" x 2"	39.3	25.7	53	72	120	340	R RI2.110G
4" x 2 1/2"	39.3	30.2	53	89	120	355	R RI2.110H
4" x 3"	39.3	33.3	53	103	120	2001	R RI2.110I

GY2 | ELBOW 45° THREADED

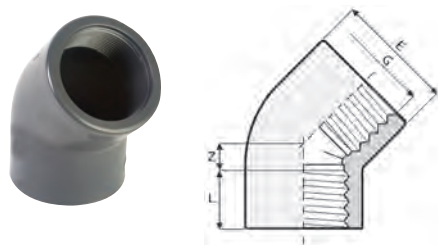

Size (G)	L	Z	E	PVC-U	
				gms	Code
1/2"	15	12	28	31	R GY2.0200
3/4"	16.3	16.7	34	49	R GY2.0250
1"	19.1	19.9	42	610	R GY2.0320
1 1/4"	21.4	25.6	51	101	R GY2.0400
1 1/2"	21.4	35.6	61	150	R GY2.0500
2"	25.7	45.3	75	290	R GY2.0630
2 1/2"	30.2	52.8	89	355	R GY2.0750
3"	33.3	64.7	106	615	R GY2.0900
4"	39.3	78.7	129	835	R GY2.1100

FF4 | FULL FACE FLANGE PLAIN DRILLED BS10 TABLE E

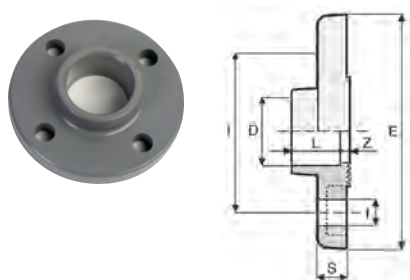

Size (D)	L	Z	E	I	f	S	No. Holes	PVC-U		ABS	
								gms	Code	gms	Code
1/2"	16	4	95	67	14	11	4	70	R FF4.0200	53	S FF4.0200
3/4"	19	4	105	73	14	12	4	87	R FF4.0250	66	S FF4.0250
1"	22	4	115	83	14	14	4	137	R FF4.0320	104	S FF4.0320
1 1/4"	26	4	140	87	14	15	4	237	R FF4.0400	180	S FF4.0400
1 1/2"	31	5	150	98	14	16	4	80	R FF4.0500	213	S FF4.0500
2"	38	5	165	115	18	18	4	395	R FF4.0630	300	S FF4.0630
3"	51	7	200	145	18	20	4	780	R FF4.0900	593	S FF4.0900
4"E	63	8	220	178	18	23	8	1100	R FF4.110E	638	S FF4.110E

> FLANGES

IMPERIAL ABS & PVC-U FITTINGS

FFN | FULL FACE FLANGE DRILLED PN16

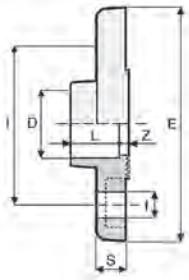

Size (D)	L	Z	E	I	f	S	No. Holes	PVC-U		ABS	
								gms	Code	gms	Code
1/2"	15	4.5	95	65	14	11	4	70	R FFN.0200	53	S FFN.0200
3/4"	19	4.5	105	75	14	12	4	05	R FFN.0250	80	S FFN.0250
1"	22	4.5	115	85	14	14	4	148	R FFN.0320	112	S FFN.0320
1 1/4"	26	4.5	142	100	18	15	4	225	R FFN.0400	171	S FFN.0400
1 1/2"	31	4.5	152	110	18	16	4	285	R FFN.0500	217	S FFN.0500
2"	38	4.5	165	125	18	18	4	420	R FFN.0630	319	S FFN.0630
2 1/2"	44	6	185	145	18	19	4	505	R FFN1.0750	384	S FFN.0750
3"	51	7	200	160	18	20	8	735	R FFN.0900	558	S FFN.0900
4"	61	8	220	180	18	22	8	930	R FFN.1100	707	S FFN.1100

QR4 | STUB FLANGE SERRATED FACE

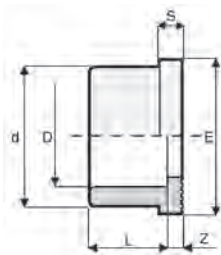

Size (D)	L	Z	d	E	S	PVC-U		ABS	
						gms	Code	gms	Code
1/2"	16	3	27	34	6	10	R QR4.0200	8	S QR4.0200
3/4"	19	3	33	41	7	14	R QR4.0250	11	S QR4.0250
1"	22	3	41	50	7	33	R QR4.0320	25	S QR4.0320
1 1/4"	26	3	50	61	8	37	R QR4.0400	28	S QR4.0400
1 1/2"	31	3	61	73	8	60	R QR4.0500	46	S QR4.0500
2"	38	3	76	90	9	110	R QR4.0630	84	S QR4.0630
2 1/2"	44	3	90	106	10	165	R QR1.0750	125	S QR4.0750
3"	51	5	108	125	11	270	R QR4.0900	205	S QR4.0900
4"	61	5	131	150	12	445	R QR4.1100	338	S QR4.1100
5"	76	5	165	188	17	735	R QR1.1400	-	-
5"	76	7	165	180	14	-	-	680	S QR4.1400
6"	86	5	191	212	16	1250	R QR4.1600	950	S QR4.1600
8"	116	8	250	270	20	2105	R QR4.2250	-	-
8"	118	14	253	269	26	-	-	2075	S QR4.2250
MTO 10"	147	8	308	326	29	3450	R QR4.2800	N/A	-
MTO 12"	169	9	362	378	33	5060	R QR4.3150	N/A	-

FCD | BLANK FLANGE DRILLED TABLE D & E

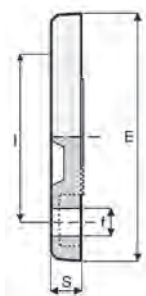

Size	E	I	f	S	No. Holes	PVC-U		ABS	
						gms	Code	gms	Code
MTO 1 1/2"	150	98	14	16	4	327	R FCD.0500	-	-
MTO 2"	165	115	18	18	4	358	R FCD.0630	272	S FCD.0630
MTO 3"	200	145	18	20	4	570	R FCD.0900	433	S FCD.0900
MTO 4"D	220	178	18	22	8	766	R FCD.1100	582	S FCD.1100
MTO 4"E	220	178	18	22	8	766	R FCD.110E	582	S FCD.110E
MTO 6"	285	235	22	28	8	1455	R FCD.1600	1106	S FCD.1600

MTO = Made to Order (Please refer to our Terms & Conditions).

> FLANGES

IMPERIAL ABS & PVC-U FITTINGS

FCN | BLANK FLANGE DRILLED PN16

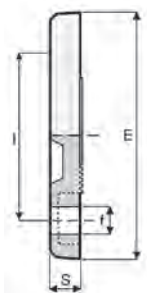

Size	E	I	f	S	No. Holes	PVC-U		ABS	
						gms	Code	gms	Code
MTO 1/2"	95	65	14	11	4	99	R FCN.0200	-	-
MTO 3/4"	105	75	14	12	4	106	R FCN.0250	-	-
MTO 1"	115	85	14	14	4	206	R FCN.0320	-	-
MTO 1 1/2"	150	110	18	16	4	327	R FCN.0500	-	-
MTO 2"	165	125	18	18	4	358	R FCN.0630	272	S FCN.0630
MTO 3"	200	160	18	20	8	570	R FCN.0900	433	S FCN.0900
MTO 4"	220	180	18	22	8	766	R FCN.1100	582	S FCN.1100
MTO 6"	285	240	22	28	8	1455	R FCN.1600	1106	S FCN.1600

FCP | BLANK FLANGE UNDRILLED

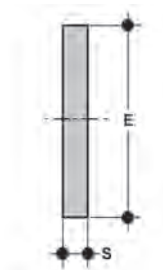

Size	E	S	PVC-U		ABS	
			gms	Code	gms	Code
MTO 1/2"	95	13	120	R FCP.0200	-	-
MTO 3/4"	105	13	145	R FCP.0250	-	-
MTO 1"	115	13	160	R FCP.0320	122	S FCP.0630
MTO 1 1/2"	150	13	250	R FCP.0500	190	S FCP.0500
MTO 2"	165	13	300	R FCP.0630	220	S FCP.0630
MTO 3"	200	20	690	R FCP.0900	524	S FCP.0900
MTO 4"	220	20	950	R FCP.1100	722	S FCP.1100
MTO 6"	250	25	2100	R FCP.1600	1596	S FCP.1600

MTO = Made to Order (Please refer to our Terms & Conditions).

> FLANGES

IMPERIAL ABS & PVC-U FITTINGS

BR4A | BACKING RING GALVANISED MILD STEEL DRILLED ANSI 150

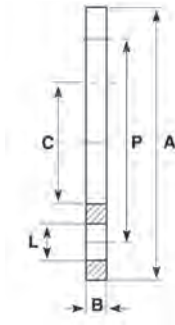

Size (D)	OD (A)	ID (C)	Thickness (B)	PCD (P)	No. Holes	Size of bolt holes (L)	Code
1/2"	89	28	8	60	4	16	G BR4.020A
3/4"	99	34	6	70	4	16	G BR4.025A
1"	108	42	8	79	4	16	G BR4.032A
1 1/4"	118	51	8	89	4	16	G BR4.040A
1 1/2"	127	62	8	98	4	16	G BR4.050A
2"	153	78	8	121	4	19	G BR4.063A
2 1/2"	178	92	8	140	4	19	G BR4.075A
3"	191	110	8	152	4	19	G BR4.090A
4"	229	133	10	191	8	19	G BR4.110A
5"	254	167	10	216	8	22	G BR4.140A
6"	280	195	10	241	8	22	G BR4.160A
8" (PVC)	343	250	15	298	8	22	G BR4.225A TO SUIT PVC STUB
8" (ABS)	340	255	12	298	8	22	G BR4.22DA TO SUIT ABS STUB

BR4 | BACKING RING GALVANISED MILD STEEL DRILLED BS10 TABLE D

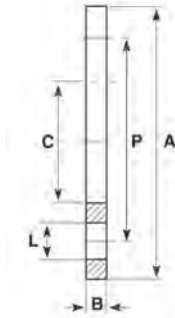
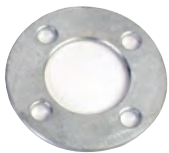

Size (D)	OD (A)	ID (C)	Thickness (B)	PCD (P)	No. Holes	Size of bolt holes (L)	Code
1 1/2"	96	29	6	68	4	16	G BR4.0200
3/4"	104	34	7	73	4	14	G BR4.0250
1"	114	42	7	84	4	14	G BR4.0320
1 1/4"	121	51	7	88	4	16	G BR4.0400
1 1/2"	134	62	8	98	4	14	G BR4.0500
2"	151	78	8	115	4	18	G BR4.0630
2 1/2"	159	92	8	127	4	18	G BR4.0750
3"	187	110	9	145	4	18	G BR4.0900
4"	216	133	10	178	8	18	G BR4.110E
5"	254	167	10	210	8	18	G BR4.1400
6"	282	195	11	235	8	22	G BR4.1600
8" (PVC)	337	250	15	292	8	22	G BR4.2250 TO SUIT PVC STUB
8" (ABS)	337	255	15	292	8	22	G BR4.225D TO SUIT ABS STUB
10"	406	308	20	356	12	22	G BR4.2800
12"	445	355	20	400	12	22	G BR4.3150

Note: For 4" Table D (4 holes) use code G BR4.110D

BR4N | BACKING RING GALVANISED MILD STEEL DRILLED PN16

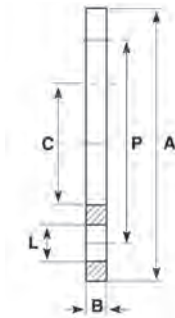

Size (D)	OD (A)	ID (C)	Thickness (B)	PCD (P)	No. Holes	Size of bolt holes (L)	Code
1/2"	90	28	8	65	4	14	G BR4.020N
3/4"	105	34	8	75	4	14	G BR4.025N
1"	115	42	8	85	4	14	G BR4.032N
1 1/4"	140	51	8	100	4	18	G BR4.040N
1 1/2"	150	68	8	110	4	18	G BR4.050N
2"	165	78	8	125	4	18	G BR4.063N
2 1/2"	185	92	8	145	4	18	G BR4.075N
3"	200	110	10	160	8	18	G BR4.090N
4"	200	133	10	180	8	18	G BR4.110N
5"	250	167	10	210	8	18	G BR4.140N
6"	285	196	10	240	8	22	G BR4.160N
8" (PVC)	340	250	15	295	12	22	G BR4.225DN TO SUIT PVC STUB
8" (ABS)	339	255	11	295	12	22	G BR4.22DN TO SUIT ABS STUB
10"	405	308	20	355	12	26	G BR4.280N
12"	460	364	20	410	12	26	G BR4.315N

GFF | GASKET-FULL FACE DRILLED BS10 TABLE D OR E



Size	E	S	No. of Holes	gms	Code
1/2"	95	3	4	30	E GFF.0200
3/4"	101	3	4	36	E GFF.0250
1"	114	3	4	35	E GFF.0320
1 1/4"	120	3	4	40	E GFF.0400
1 1/2"	135	3	4	55	E GFF.0500
2"	156	3	4	57	E GFF.0630
2 1/2"	165	3	4	56	E GFF.0750
3"	186	3	4	99	E GFF.0900
4" D*	219	3	8	114	E GFF.1100
4" E*	219	3	4	116	E GFF.110E
6"	279	3	8	160	E GFF.1600

Note: 4" is available in either Table D or Table E format

GFN | GASKET-FULL FACE DRILLED PN16



Size	E	S	No. of Holes	gms	Code
1/2"	95	3	4	30	E GFN.0200
3/4"	101	3	4	36	E GFN.0250
1"	114	3	4	35	E GFN.0320
1 1/4"	120	3	4	40	E GFN.0400
1 1/2"	135	3	4	55	E GFN.0500
2"	156	3	4	57	E GFN.0630
2 1/2"	176	3	4	78	E GFN.0750
3"	186	3	8	99	E GFN.0900
4"	219	3	8	114	E GFN.1100
6"	279	3	8	160	E GFN.1600

GQP | GASKET-STUB FLANGE FOR QR4 STUBS

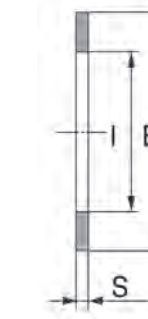

Size	I	E	S	Code
1/2"	20	32	2	E GQP.0200
3/4"	25	39	2	E GQP.0250
1"	32	48	2	E GQP.0320
1 1/4"	40	59	2	E GQP.0400
1 1/2"	50	71	2	E GQP.0500
2"	63	88	2	E GQP.0630
2 1/2"	75	104	2	E GQP.0750
3"	90	123	2	E GQP.0900
4"	110	148	3	E GQP.1100
5"	140	186	3	E GQP.1400
6"	160	211	3	E GQP.1600
8"	220	270	3	E GQP.2250

724E | IMPERIAL DOUBLE UNION BALL VALVE PLAIN WITH EPDM SEALS

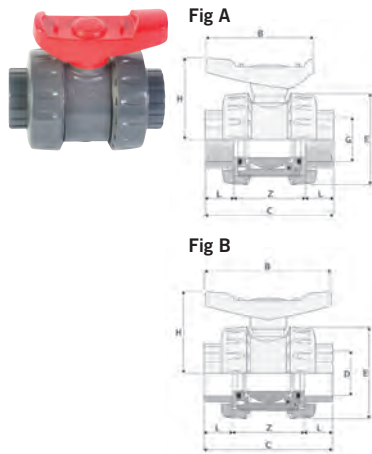

Size	DN	L	Z	C	E	H	B	Ref	PVC-U		ABS	
									gms	Code	gms	Code
1/2"	15	17	48	82	53	51	66	A	145	I 724.0200	174	S 724.0200
3/4"	20	19	53	91	62	59	77	A	220	I 724.0250	235	S 724.0250
1	25	22	59	103	71	66	88	A	315	I 724.0320	314	S 724.0320
1 1/4"	32	26	68	120	84	77	102	A	505	I 724.0400	457	S 724.0400
1 1/2"	40	31	77	139	98	87	117	A	725	I 724.0500	731	S 724.0500
2"	50	38	98	174	117	105	140	A	1245	I 724.0630	1116	S 724.0630
2 1/2"	65	44	142	230	168	151	212	B	3400	I 724.0750	3222	S 724.0750
3"	80	51	142	244	168	151	212	B	3500	I 724.0900	3357	S 724.0900
4"	100	61	162	284	210	178	212	B	5900	I 724.1100	5720	S 724.1100

724F | IMPERIAL DOUBLE UNION BALL VALVE PLAIN WITH FPM SEALS

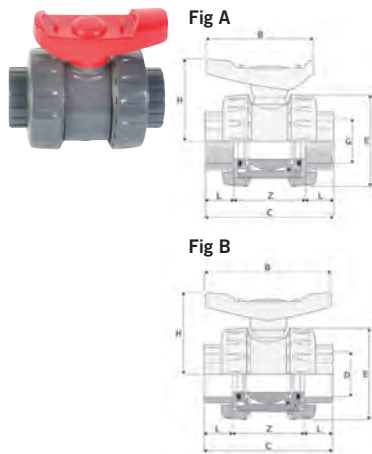

Size	DN	L	Z	C	E	H	B	Ref	PVC-U		ABS	
									gms	Code	gms	Code
1/2"	15	17	48	82	53	51	66	A	145	I 724.020F	174	S 724.020F
3/4"	20	19	53	91	62	59	77	A	220	I 724.025F	235	S 724.025F
1	25	22	59	103	71	66	88	A	315	I 724.032F	314	S 724.032F
1 1/4"	32	26	68	120	84	77	102	A	505	I 724.040F	457	S 724.040F
1 1/2"	40	31	77	139	98	87	117	A	725	I 724.050F	731	S 724.050F
2"	50	38	98	174	117	105	140	A	1245	I 724.063F	1116	S 724.063F
2 1/2"	65	44	142	230	168	151	212	B	3400	I 724.075F	3222	S 724.075F
3"	80	51	142	244	168	151	212	B	3500	I 724.090F	3357	S 724.090F
4"	100	61	162	284	210	178	212	B	5900	I 724.110F	5720	S 724.110F

725E | THREADED DOUBLE UNION BALL VALVE PLAIN WITH EPDM SEALS

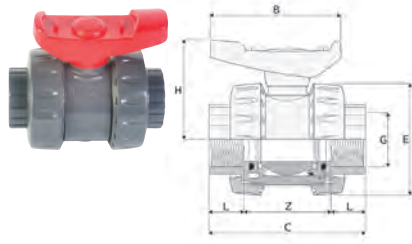

Size	DN	L	Z	C	E	H	B	PVC-U		ABS	
								gms	Code	gms	Code
1/2"	15	17	56	90	53	51	66	145	T 725.0200	174	S 725.0200
3/4"	20	19	55	93	62	59	77	225	T 725.0250	235	S 725.0250
1	25	22	66	110	71	66	88	320	T 725.0320	314	S 725.0320
1 1/4"	32	24	79	127	84	77	102	515	T 725.0400	457	S 725.0400
1 1/2"	40	24	83	131	98	87	117	735	T 725.0500	731	S 725.0500
2"	50	29	103	161	117	105	140	1260	T 725.0630	1116	S 725.0630

725F | THREADED DOUBLE UNION BALL VALVE PLAIN WITH FPM SEALS

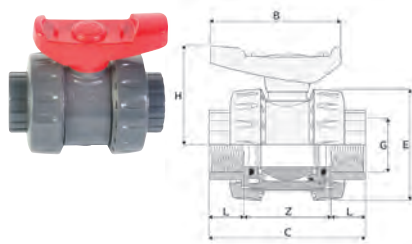

Size	DN	L	Z	C	E	H	B	PVC-U		ABS	
								gms	Code	gms	Code
1/2"	15	17	56	90	53	51	66	145	T 725.020F	174	S 725.020F
3/4"	20	19	55	93	62	59	77	225	T 725.025F	235	S 725.025F
1	25	22	66	110	71	66	88	320	T 725.032F	314	S 725.032F
1 1/4"	32	24	79	127	84	77	102	515	T 725.040F	457	S 725.040F
1 1/2"	40	24	83	131	98	87	117	735	T 725.050F	731	S 725.050F
2"	50	29	103	161	117	105	140	1260	T 725.063F	1116	S 725.063F

Note: ABS Threaded valves will be supplied complete with 2 x ABS Female threaded adaptors

322E | IMPERIAL DOUBLE UNION BALL VALVE PLAIN WITH EPDM SEALS

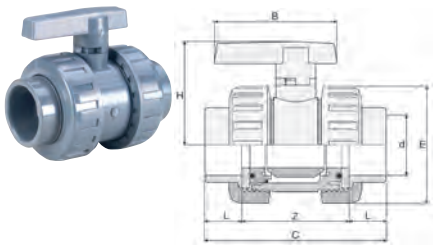

Size	DN	L	Z	C	E	H	B	PVC-U	
								gms	Code
1/2"	15	17	47	81	50	50	57	200	I 322.0200
3/4"	20	19	57	95	59	55	66	250	I 322.0250
1"	25	22	61	105	68	63	75	320	I 322.0320
1 1/4"	32	26	72	124	80	76	90	400	I 322.0400
1 1/2"	40	31	84	146	96	88	103	500	I 322.0500
2"	50	38	96	172	116	102	121	630	I 322.0630
2 1/2"	65	44	170	258	196	151	212	750	I 322.0750
3"	80	51	170	272	196	151	212	900	I 322.0900
4"	100	61	193	315	239	178	212	55	I 322.1100

321E | IMPERIAL THREADED DOUBLE UNION BALL VALVE WITH EPDM SEALS

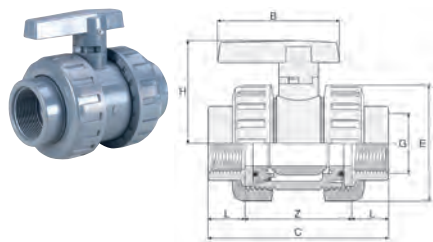

Size	DN	L	Z	C	E	H	B	PVC-U	
								gms	Code
1/2"	15	17	47	81	50	50	57	135	T 321.0200
3/4"	20	19	57	95	59	55	66	215	T 321.0250
1"	25	22	61	105	68	63	75	310	T 321.0320
1 1/4"	32	26	72	124	80	76	90	460	T 321.0400
1 1/2"	40	31	84	146	96	88	103	730	T 321.0500
2"	50	38	96	172	116	102	121	1130	T 321.0630
2 1/2"	65	44	170	258	196	151	212	3060	T 321.0750
3"	80	51	170	272	196	151	212	3110	T 321.0900
4"	100	61	193	315	239	178	212	5550	T 321.1100

1930 | 3-WAY BALL VALVE PLAIN EPDM SEALS

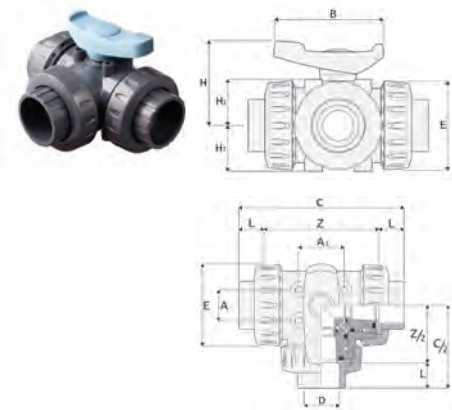

Size	DN	H	B	E	L	Z	C	H1	A1	A	PVC-U	
											gms	Code
1/2"	15	52	66	53	17	74	108	27.55	24	24	245	I 930.0200
3/4"	20	61	77	62	19	90	128	32.5	31	25	385	I 930.0250
1"	25	68	88	71	22	100	144	36.5	40	27	560	I 930.0320
1 1/4"	32	76	102	84	26	121	173	43	41	32	875	I 930.0400
1 1/2"	40	91	117	98	30	137	197	51.5	53	28	1290	I 930.0500
2"	50	107	140	117	36	171	243	59.5	58	35	2085	I 930.0630

Note: FPM seal options available

T931 | 3-WAY BALL VALVE THREADED EPDM SEALS

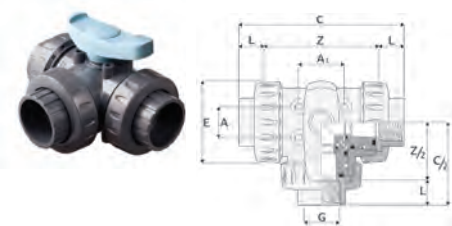

Size	DN	H	B	E	L	Z	C	H1	A1	A	PVC-U	
											gms	Code
1/2"	15	52	66	53	15	86	116	27.5	24	24	245	T 931.0200
3/4"	20	61	77	62	16	98	130	32.5	31	25	385	T 931.0250
1"	25	68	88	71	19	113	151	36.5	40	27	560	T 931.0320
1 1/4"	32	76	102	84	22	136	180	43	41	32	875	T 931.0400
1 1/2"	40	91	117	98	22	145	189	51.5	53	28	1290	T 931.0500
2"	50	107	140	117	26	178	230	59.5	58	35	2085	T 931.0630

Note: FPM seal options available

M800 | BUTTERFLY VALVE EPDM SEALS (Note: Lugged options available on request)

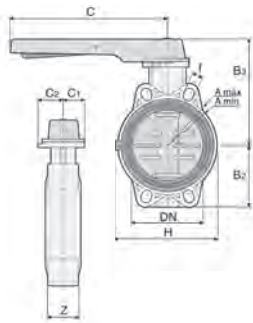

Size	DN	B ₂	B ₃	C	C ₁	C ₂	H	Z	A	A	F	No. Holes	PVC-U	
													gms	Code
1½"/50mm	40	60	136	175	45	42	132	33	93	109	19	4	827	M 800.0500
2"/63mm	50	70	143	175	45	42	147	43	108	124	19	4	1012	M 800.0630
2½"/75mm	65	80	168	250	45	53	165	46	128	144	19	4	1420	M 800.0750
3"/90mm	80	90	182	250	45	53	130	49	145	159	19	4	1640	M 800.0900
4"/110mm	100	105	196	250	45	53	150	56	165	190	19	4	1990	M 800.1100
5"/140mm	125	121	215	355	45	53	185	64	204	215	23	4	3030	M 800.1400
6"/160mm	150	132	229	355	45	53	210	70	230	242	23	4	3730	M 800.1600
8"/225mm	200	161	309	425	65	82	325	71	280	298	23	8	8240	M 800.2250

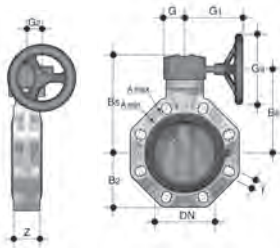

Size	DN	B ₂	B ₅	B ₆	G	G ₁	G ₂	G ₃	Z	A	A	F	No. Holes	PVC-U	
														gms	Code
10"/280mm	250	210	317	281	88	236	76	250	114	335	362	25	12	18600	M 800.2800
12"/315mm	300	245	374	338	88	236	76	250	114	390	432	29	12	25600	M 800.3150

>VALVES

IMPERIAL ABS & PVC-U VALVES

21NE | DOUBLE UNION BALL NON RETURN PLAIN WITH EPDM SEALS

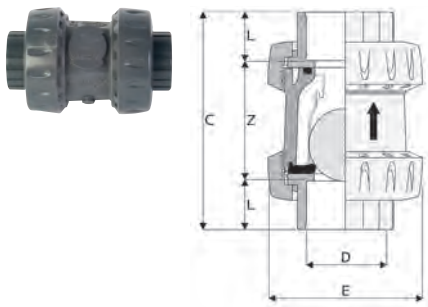

Size	DN	L	Z	C	E	PVC-U	
						gms	Code
1/2"	15	17	48	82	53	105	I 21N.0200
3/4"	20	19	53	91	62	150	I 21N.0250
1"	25	22	59	103	71	250	I 21N.0320
1 1/4"	32	26	68	120	84	370	I 21N.0400
1 1/2"	40	31	77	139	98	590	I 21N.0500
2"	50	38	98	174	117	990	I 21N.0630

Note: FPM seal options available

22NE | DOUBLE UNION NON-RETURN BALL VALVE THREADED EPDM SEALS

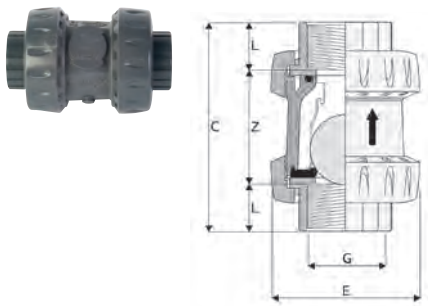

Size	DN	L	Z	C	E	PVC-U	
						gms	Code
1/2"	15	17	56	90	53	105	T 22N.0200
3/4"	20	19	55	93	62	150	T 22N.0250
1"	25	22	66	110	71	250	T 22N.0320
1 1/4"	32	24	79	127	84	370	T 22N.0400
1 1/2"	40	24	83	131	98	590	T 22N.0500
2"	50	29	103	161	117	990	T 22N.0630

Note: FPM seal options available

21AE | DOUBLE UNION AIR RELEASE VALVE PLAIN EPDM SEALS

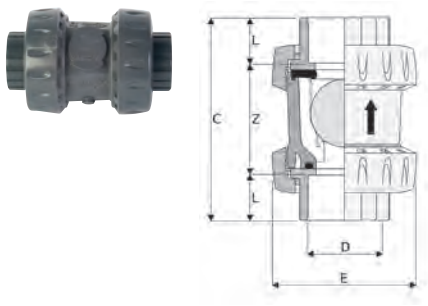

Size	DN	L	Z	C	E	PVC-U	
						gms	Code
1/2"	15	17	48	82	53	100	I 21A.0200
3/4"	20	19	53	91	62	140	I 21A.0250
1"	25	22	59	103	71	230	I 21A.0320
1 1/4"	32	26	68	120	84	350	I 21A.0400
1 1/2"	40	31	77	139	98	560	I 21A.0500
2"	50	38	98	174	117	950	I 21A.0630

Note: FPM seal options available

22AE | DOUBLE UNION AIR RELEASE VALVE THREADED EPDM SEALS

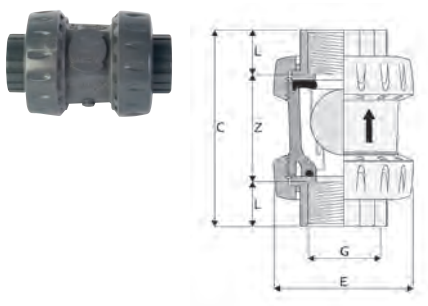

Size	DN	L	Z	C	E	PVC-U	
						gms	Code
1/2"	15	17	56	90	53	100	T 22A.0200
3/4"	20	19	55	93	62	140	T 22A.0250
1"	25	22	66	110	71	230	T 22A.0320
1 1/4"	32	24	79	127	84	350	T 22A.0400
1 1/2"	40	24	83	131	98	560	T 22A.0500
2"	50	29	103	161	117	950	T 22A.0630

Note: FPM seal options available

>VALVES

IMPERIAL ABS & PVC-U VALVES

230 | DOUBLE UNION SPRING CHECK VALVE PLAIN EPDM SEALS

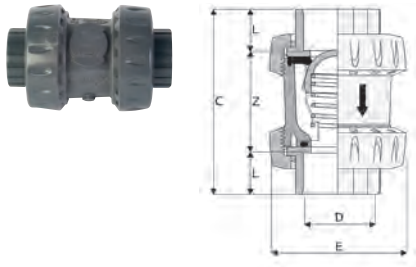

Size	DN	L	Z	C	E	PVC-U	
						gms	Code
1/2"	15	17	48	82	53	105	I 230.0200
3/4"	20	19	53	91	62	150	I 230.0250
1"	25	22	59	103	71	250	I 230.0320
1 1/4"	32	26	68	120	84	370	I 230.0400
1 1/2"	40	31	77	139	98	590	I 230.0500
2"	50	38	98	174	117	990	I 230.0630

Note: FPM seal options available

230 | DOUBLE UNION SPRING CHECK VALVE THREADED EPDM SEALS

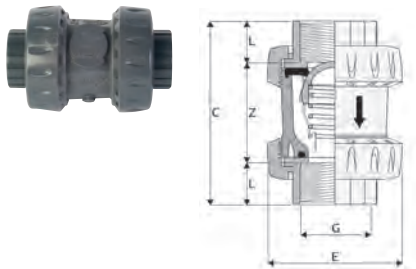

Size	DN	L	Z	C	E	PVC-U	
						gms	Code
1/2"	15	17	56	90	53	105	T 230.0200
3/4"	20	19	55	93	62	150	T 230.0250
1"	25	22	66	110	71	250	T 230.0320
1 1/4"	32	24	79	127	84	370	T 230.0400
1 1/2"	40	24	83	131	98	590	T 230.0500
2"	50	29	103	161	117	990	T 230.0630

Note: FPM seal options available

FLT | FOOT VALVE FILTER

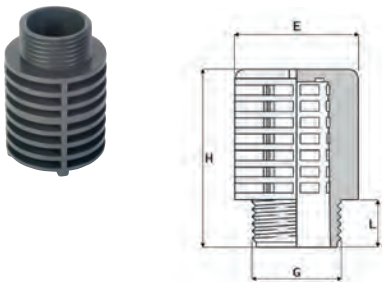

Size	L	H	E	PVC-U	
				gms	Code
3/4"	12	55	36.5	28	T FLT.0250
1"	15.5	69	46.5	55	T FLT.0320
1 1/4"	15.5	82.5	59	100	T FLT.0400
1 1/2"	16	90.5	66	125	T FLT.0500
2"	15	108.5	81	220	T FLT.0630

CLP | WAFER CHECK VALVE



Size	DN	De	Z	Di	A	B	C	A (hor) A (vert)		B	PVC-U	
								Bar	Bar		gms	Code
1 1/2"/50mm	40	95	16	21	72	25	28	0.001	0.004	0.3	160	M CLP.0500
2"/63mm	50	109	20	32	86	37	29	0.001	0.004	0.4	250	M CLP.0630
2 1/2"/75mm	65	129	20	40	105	50	31	0.001	0.004	0.3	320	M CLP.0750
3"/90mm	80	144	20	54	119	61	32	0.001	0.007	0.2	390	M CLP.0900
4"/110mm	100	164	22	70	146	77	31	0.001	0.007	0.2	550	M CLP.1100
5"/140mm	125	195	23	92	173	94	35	0.001	0.007	0.3	750	M CLP.1400
6"/160mm	150	220	25	112	197	115	35	0.001	0.007	0.1	1100	M CLP.1600
8"/225mm	200	275	35	154	225	152	38	0.001	0.012	0.1	2100	M.CLP.2250
10"/280mm	250	330	40	192	312	180	41	0.001	0.012	0.1	3500	M CLP.2800
12"/315mm	300	380	45	227	363	215	41	0.001	0.012	0.1	5300	M CLP.3150

Note: FPM seal options available

A - Minimum pressure for valve opening

B - Minimum pressure for valve sealing

>VALVES

IMPERIAL ABS & PVC-U VALVES

305E | SINGLE UNION BALL VALVE WITH COMPRESSION ENDS / FEMALE THREADED EPDM SEALS

MTO

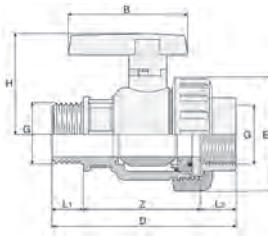

Size	DN	L	C	E	H	B	PVC-U	
							gms	Code
16 x 3/8"	10	14	99	50	50	57	42	T 305.016A
20 x 1/2"	15	17	99	50	50	57	46	T 305.020B
25 x 3/4"	20	19	115	59	55	66	110	T 305.025C
32 x 1"	25	22	131	68	63	75	211	T 305.032D
40 x 1 1/4"	32	26	158	80	76	90	320	T 305.040E
50 x 1 1/2"	40	31	181	96	88	103	460	T 305.050F
63 x 2"	50	38	221	116	102	121	690	T 305.063G

AQP/APP & AQA/APA | PNEUMATIC ACTUATED BALL VALVE SPRING RETURN EPDM SEALS



Size	AQP/APP		AQP/APP	
	PVC-U Fail Safe Open	PVC-U Fail Safe Close	ABS Fail Safe Open	ABS Fail Safe Close
1/2"	AQPI0200	APPI0200	AQAI0200	APAI0200
3/4"	AQPI0250	APPI0250	AQAI0250	APAI0250
1"	AQPI0320	APPI0320	AQAI0320	APAI0320
1 1/4"	AQPI0400	APPI0400	AQAI0400	APAI0400
1 1/2"	AQPI0500	APPI0500	AQAI0500	APAI0500
2"	AQPI0630	APPI0630	AQAI0630	APAI0630

ARP & ARA | PNEUMATIC ACTUATED BALL VALVE DOUBLE ACTING EPDM SEALS



Size	ARP	ARA
	PVC-U Double Acting	ABS Double Acting
1/2"	ARPI0200	ARAI0200
3/4"	ARPI0250	ARAI0250
1"	ARPI0320	ARAI0320
1 1/4"	ARPI0400	ARAI0400
1 1/2"	ARPI0500	ARAI0500
2"	ARPI0630	ARAI0630

AQP/APP | PNEUMATIC ACTUATED BUTTERFLY VALVE SPRING RETURN EPDM SEALS



Size	PVC-U	PVC-U
	Fail Safe Open	Fail Safe Close
2 1/2"/75mm	AQPB0750	APPB0750
3"/90mm	AQPB0900	APPB0900
4"/110mm	AQPB1100	APPB1100
5"/140mm	AQPB1400	APPB1400
6"/160mm	AQPB1600	APPB1600
8"/225mm	AQPB2250	APPB2250

>VALVES

IMPERIAL ABS & PVC-U ACCESSORIES

ARP/APP | PNEUMATIC ACTUATED BUTTERFLY VALVE DOUBLE ACTING EPDM SEALS



Size	PVC-U Double Acting	xxx
2½"/75mm	ARPB0750	APPB0750
3"/90mm	ARPB0900	APPB0900
4"/110mm	ARPB1100	APPB1100
5"/140mm	ARPB1400	APPB1400
6"/160mm	ARPB1600	APPB1600
8"/225mm	ARPB2250	APPB2250

A1P/A2P & A1A/A2A | ELECTRIC ACTUATED BALL VALVE EPDM SEALS



Size	A1P/A2P		A1A/A2A	
	PVC-U 110V/220V AC	PVC-U 24V DC	ABS 110V/220V AC	ABS 24V DC
½"	A1PI0200	A2PI0200	A1AI0200	APAI0200
¾"	A1PI0250	A2PI0250	A1AI0250	APAI0250
1"	A1PI0320	A2PI0320	A1AI0320	APAI0320
1¼"	A1PI0400	A2PI0400	A1AI0400	APAI0400
1½"	A1PI0500	A2PI0500	A1AI0500	APAI0500
2"	A1PI0630	A2PI0630	A1AI0630	APAI0630

MK | VALVE ACTUATOR KIT



Size	Mounting	Code
DN15	F04	HZMK1102
DN20	F04	HZMK1103
DN32	F04	HZMK1104
DN15	F05	HZMK2102
DN20	F05	HZMK2103
DN32	F05	HZMK2104
DN40	F05	HZMK2105
DN50	F05	HZMK2106
DN63	F05	HZMK2107
DN50	F07	HZMK3106
DN63	F07	HZMK3107

NOTE: Kit includes; mounting plate, mounting legs, drive shaft, 4 x screws, 1 x mounting screw & 6 x washers

MTO = Made to Order (Please refer to our Terms & Conditions).

ST4 | PIPE BRACKET

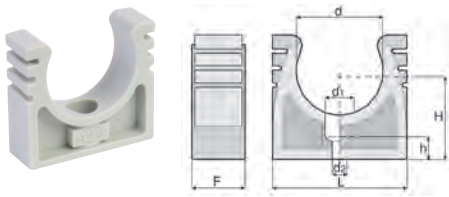

Fig A

Size	H	L	d2	d1	h	F	Fig.	Pck	gms	Code
3/8"	22.0	28.0	5.5	10.5	7.5	16.0	A	10	6	P ST4.0160
1/2"	24.5	33.0	5.5	10.5	7.5	16.0	A	10	7	P ST4.0200
3/4"	28.2	38.0	5.5	10.5	7.5	16.0	A	10	9	P ST4.0250
1"	31.5	48.0	5.5	10.5	7.5	16.0	A	10	13	P ST4.0320

ST4 | PIPE BRACKET WITH STRAP



Fig B

Size	H	L	d2	d1	h	F	Fig.	Pck	gms	Code
1 1/4"	41.5	54.0	5.5	10.5	7.5	20.0	B	10	23	P ST4.0400
1 1/2"	46.5	64.5	7.0	14.0	9.0	23.0	B	10	29	P ST4.0500
2"	56.0	80.0	7.0	14.0	9.0	25.0	B	10	39	P ST4.0630
2 1/2"	63.6	94.0	9.0	17.0	10.5	27.5	B	10	55	P ST1.0750
3"	72.0	115.0	9.0	17.0	13.5	30.0	B	10	85	P ST4.0900
4"	81.0	138.5	9.0	17.0	13.5	30.0	B	10	100	P ST4.1100

>ACCESSORIES

IMPERIAL ABS & PVC-U ACCESSORIES

PCO | PVC-U SOLVENT CEMENT



Size	Code
1/2 litre	R PCO.0200

N.B. Accessory discount applies to this item

PCO | PVC-U RH (THF FREE) SOLVENT CEMENT



Size	Code
1/2 litre	R PCO.0300

N.B. Accessory discount applies to this item

ACO | ABS SOLVENT CEMENT



Size	Code
1/2 litre	S ACO.0200

N.B. Accessory discount applies to this item

CFO | ECO CLEANER



Size	Code
1/2 litre	M CFO.0200

N.B. Accessory discount applies to this item

PCO | PVC-U HCR CHEMICAL RESISTANT SOLVENT CEMENT



Size	Code
1 litre	R PCO.0100

N.B. Accessory discount applies to this item

CFO | CHEMICAL RESISTANT CLEANER



Size	Code
1/2 litre	M CFO.0100

N.B. Accessory discount applies to this item

CHAMFERRING TOOLS



Size	Code
16-63mm chamfering tool	C AF0.0100



32-160mm chamfering tool	C AF0.0102
--------------------------	------------

PIPE CUTTER



Size	Code
16-63mm	T TF0.0100
50-125mm	T TF0.0101
16-63mm spare cutter wheel	T TF0.0102
50-125mm spare cutter wheel	T TF0.0103

FIBRESEAL (Sealing tape for threaded connections)



Description	Code
Fibre Seal tape	F AF0.0100

>PREMIUM PVC-U PIPE

DURAPIPE UK PREMIUM
PVC-U PIPE (Fully Approved)

P10 | PVC-U PRESSURE PIPE 10 BAR PLAIN END

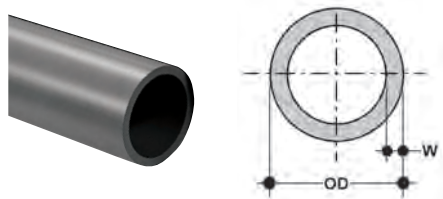

Size	Min. Wall (w) mm	Weight kg/m	Length m	Code
32	1.6	0.24	5	R P10.0320
40	1.9	0.35	5	R P10.0400
50	2.4	0.552	5	R P10.0500
63	2.4	0.705	5	R P10.0630
75	2.9	0.998	5	R P10.0750
90	3.5	1.443	5	R P10.0900
110	4.2	2.113	5	R P10.1100
125	4.8	2.718	5	R P10.1250
160	6.2	4.491	5	R P10.1600
200	7.7	6.98	5	R P10.2000
250	9.6	10.87	5	R P10.2500
315	12.1	17.50	5	R P10.3150

5 metre lengths

P16 | PVC-U PRESSURE PIPE 16 BAR PLAIN END

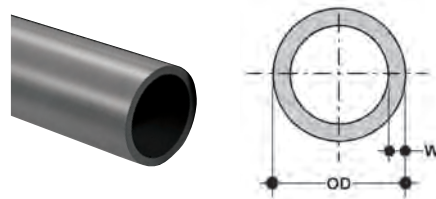

Size	Min. Wall (w) mm	Weight kg/m	Length m	Code
20	1.5	0.137	5	R P16.0200
25	1.9	0.212	5	R P16.0250
32	3.0	0.342	5	R P16.0320
40	3.0	0.525	5	R P16.0400
50	3.7	0.809	5	R P16.0500
63	3.8	1.064	5	R P16.0630
75	4.5	1.5	5	R P16.0750
90	5.4	2.152	5	R P16.0900
110	6.6	3.197	5	R P16.1100

5 metre lengths

>OPTIMA PVC-U PIPE

OPTIMA PVC-U PIPE

M10 | OPTIMA PIPE PVC-U PN10 PLAIN END

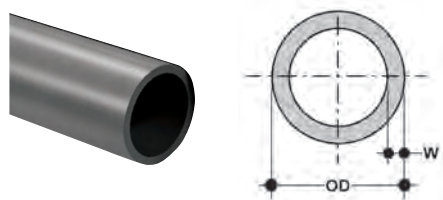

Size	Min. Wall (w) mm	Weight kg/m	Length m	Code
32	1.6	0.24	5	R M10.0320
40	1.9	0.35	5	R M10.0400
50	2.4	0.55	5	R M10.0500
63	3.0	0.71	5	R M10.0630
75	3.6	1.00	5	R M10.0750
90	4.3	1.44	5	R M10.0900
110	4.2	2.11	5	R M10.1100
125	4.8	2.72	5	R M10.1250
160	6.2	4.49	5	R M10.1600

M16 | OPTIMA PIPE PVC-U PN16 PLAIN END

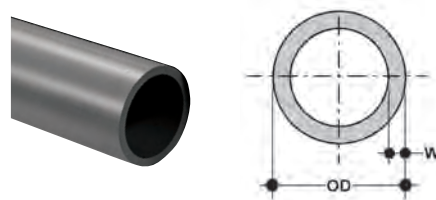

Size	Min. Wall (w) mm	Weight kg/m	Length m	Code
20	1.5	0.13	5	R M16.0200
25	1.9	0.20	5	R M16.0250
32	2.4	0.34	5	R M16.0320
40	3.0	0.51	5	R M16.0400
50	3.7	0.79	5	R M16.0500
63	4.7	1.25	5	R M16.0630
75	5.6	1.50	5	R M16.0750
90	6.7	2.15	5	R M16.0900
110	6.6	3.20	5	R M16.1100

> FITTINGS PLAIN

METRIC PVC-U FITTINGS

MA1 | SOCKET PLAIN

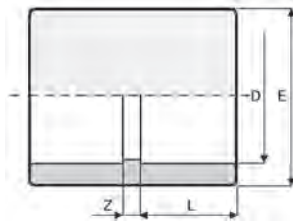
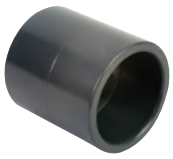

Size	L	Z	E	PVC-U	
				gms	Code
16	14	3	23	10	R MA1.0160
20	16	3	28	15	R MA1.0200
25	19	3	34	20	R MA1.0250
32	22	3	42	30	R MA1.0320
40	26	3	51	60	R MA1.0400
50	31	3	61	85	R MA1.0500
63	38	3	75	140	R MA1.0630
75	44	4	89	215	R MA1.0750
90	51	5	106	355	R MA1.0900
110	61	6	129	605	R MA1.1100
125	69	7	145	935	R MA1.1250
140	76	8	162	1100	R MA1.1400
160	86	8	182	1380	R MA1.1600
200	106	12	231	3810	R MA1.2000
225	119	11	262	4755	R MA1.2250
250	131	10	286	5760	R MA1.2500
280	146	10	320	7630	R MA1.2800
315	164	12	355	9780	R MA1.3150

G01 | ELBOW 90° PLAIN*

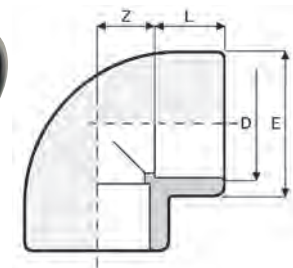
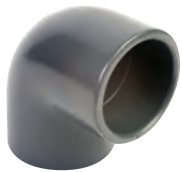

Size	L	Z	E	PVC-U	
				gms	Code
16	14	9	23	14	R G01.0160
20	16	11	28	25	R G01.0200
25	19	14	34	35	R G01.0250
32	22	17	42	35	R G01.0320
40	26	21	51	95	R G01.0400
50	31	26	61	145	R G01.0500
63	38	33	75	230	R G01.0630
75	44	39	89	385	R G01.0750
90	51	47	106	600	R G01.0900
110	61	57	129	1020	R G01.1100
125	69	66	146	1385	R G01.1250
140	76	72	163	2125	R G01.1400
160	86	82	186	2920	R G01.1600
200	106	102	230	5400	R G01.2000
225	119	115	258	7550	R G01.2250
250	131	188	287	12480	R G01.2500
280	147	210	325	17000	R G01.2800
315	164	236	359	23370	R G01.3150

> FITTINGS PLAIN

METRIC PVC-U FITTINGS

GY1 | ELBOW 45° PLAIN

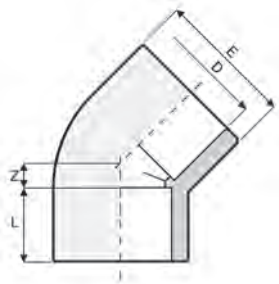

Size	L	Z	E	PVC-U	
				gms	Code
16	14	5	23	20	R GY1.0160
20	16	5	28	20	R GY1.0200
25	19	6	34	25	R GY1.0250
32	22	8	42	45	R GY1.0320
40	26	10	51	75	R GY1.0400
50	31	12	61	110	R GY1.0500
63	38	14	75	230	R GY1.0630
75	44	17	89	300	R GY1.0750
90	51	20	106	420	R GY1.0900
110	61	24	129	835	R GY1.1100
125	69	27	145	1085	R GY1.1250
140	76	31	163	1620	R GY1.1400
160	86	35	186	2265	R GY1.1600
200	108	48	230	4500	R GY1.2000
225	121	55	260	6400	R GY1.2250
250	131	58	286	7700	R GY1.2500
280	146	62	320	10460	R GY1.2800
315	164	66	359	15500	R GY1.3150

CU4 | BEND 90° PLAIN

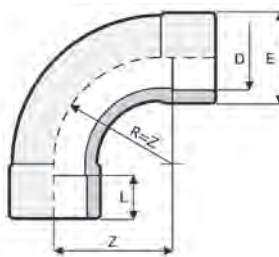

Size	L	Z	E	PVC-U	
				gms	Code
20	16	40	28	45	R CU1.0200
25	19	50	34	75	R CU1.0250
32	22	64	41	120	R CU1.0320
40	26	80	51	205	R CU1.0400
50	31	100	65	310	R CU1.0500
63	38	126	77	510	R CU1.0630
75	44	150	94	995	R CU1.0750
90	51	180	113	1765	R CU1.0900
110	61	220	137	2805	R CU1.1100

MA5 | IMPERIAL/METRIC SOCKET PLAIN

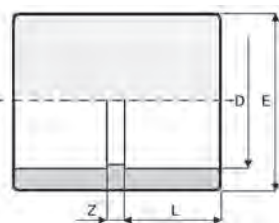
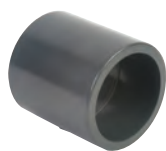

Size	L	Z	E	PVC-U	
				gms	Code
1/2" x 20	16	2.5	27	12	R MA5.0200
3/4" x 25	19	2.5	33	22	R MA5.0250
1" x 32	22	2.5	41	44	R MA5.0320
1 1/4" x 40	26	2	50	65	R MA5.0400
1 1/2" x 50	31	4	61	125	R MA5.0500
2" x 63	38	5	76	210	R MA5.0630
2 1/2" x 75	46	3	88	230	R MA1.0750
3" x 90	51	5.5	108	438	R MA5.0900
4" x 110	61	4	132	852	R MA5.1100

> FITTINGS PLAIN

METRIC PVC-U FITTINGS

T11 | TEE 90° PLAIN



Size	L	Z	E	PVC-U	
				gms	Code
16	14	9	23	13	R T11.0160
20	16	11	28	35	R T11.0200
25	19	14	34	50	R T11.0250
32	22	17	42	70	R T11.0320
40	26	21	51	120	R T11.0400
50	31	26	61	185	R T11.0500
63	38	33	75	305	R T11.0630
75	44	39	89	505	R T11.0750
90	51	47	106	795	R T11.0900
110	61	57	129	1415	R T11.1100
125	69	66	146	2020	R T11.1250
140	76	72	163	2740	R T11.1400
160	86	82	186	3855	R T11.1600
200	106	102	230	6960	R T11.2000
225	119	115	258	9600	R T11.2250
250	131	128	286	13250	R T11.2500
280	146	144	319	17840	R T11.2800
315	164	162	360	25300	R T11.3150

B01 | UNION PLAIN

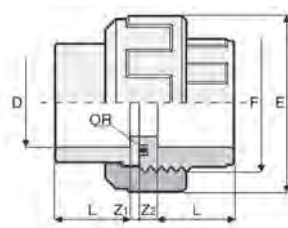

Size	L	Z ₁	Z ₂	F	E	O R	Pn	PVC-U	
								gms	Code
16	11	3	10	3/4"	31	3062	16	30	R B01.0160
20	16	3	10	1"	42	4081	16	42	R B01.0200
25	19	3	10	1 1/4"	52	4112	16	70	R B01.0250
32	22	3	10	1 1/2"	59	4131	16	97	R B01.0320
40	26	3	12	2"	72	6162	16	156	R B01.0400
50	31	3	14	2 1/4"	79	6187	16	216	R B01.0500
63	38	3	18	2 3/4"	96	6237	16	368	R B01.0630
75	44	3	20	3 1/2"	116.6	6312	10	560	R B01.0750
90	51	5	20	4"	131	6362	6	750	R B01.0900
110	61	5	20	5"	159.4	6450	6	1300	R B01.1100

CA1 | END CAP PLAIN

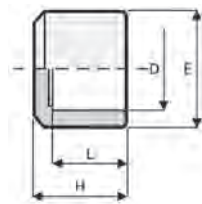
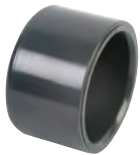

Fig A

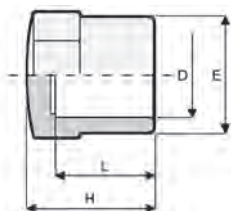

Fig B

Size	L	H	E	fig.	PVC-U	
					gms	Code
16	14	22	23	B	49	R CA1.0160
20	16	24	28	A	49	R CA1.0200
25	19	27	34	A	49	R CA1.0250
32	22	30	42	A	33	R CA1.0320
40	26	35	51	A	50	R CA1.0400
50	31	40	61	A	70	R CA1.0500
63	38	48	75	A	115	R CA1.0630
75	44	59	89	B	228	R CA1.0750
90	51	67	106	B	349	R CA1.0900
110	61	77	129	B	530	R CA1.1100
125	69	98	145	A	660	R CA1.1250
140	76	108	162	A	860	R CA1.1400
160	86	123	182	A	1080	R CA1.1600

RC1 | REDUCING BUSH PLAIN*

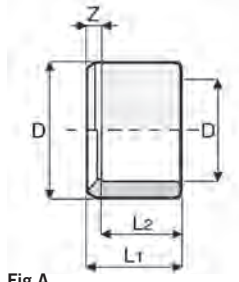
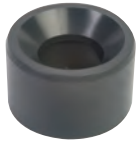

Fig A

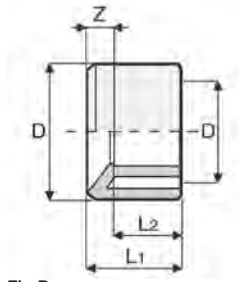

Fig B

Size	L ₁	L ₂	Z	fig.	PVC-U	
					gms	Code
20 x 16	16	14	2	A	5	R RC1.020A
25 x 16	19	14	5	B	10	R RC1.025A
25 x 20	19	16	3	A	5	R RC1.025B
32 x 16	22	14	8	B	15	R RC1.032A
32 x 20	22	16	6	B	18	R RC1.032B
32 x 25	22	19	3	A	10	R RC1.032C
40 x 20	26	16	10	B	25	R RC1.040B
40 x 25	26	19	7	B	32	R RC1.040C
40 x 32	26	22	4	A	15	R RC1.040D
50 x 25	31	19	12	B	45	R RC1.050C
50 x 32	31	22	9	B	44	R RC1.050D
50 x 40	31	26	5	A	31	R RC1.050E
63 x 32	38	22	16	B	80	R RC1.063D
63 x 40	38	26	12	B	80	R RC1.063E
63 x 50	38	31	7	A	65	R RC1.063F
75 x 40	44	26	18	B	120	R RC1.075E
75 x 50	44	31	13	B	120	R RC1.075F
75 x 63	44	38	6	A	85	R RC1.075G
90 x 50	51	31	20	B	220	R RC1.090F
90 x 63	51	38	13	B	205	R RC1.090G
90 x 75	51	44	7	A	150	R RC1.090H
110 x 63	61	38	23	B	375	R RC1.110G
110 x 75	61	44	17	B	380	R RC1.110H
110 x 90	61	51	9	A	280	R RC1.110I
125 x 75	69	44	25	B	440	R RC1.125H
125 x 90	69	51	18	B	455	R RC1.125I
125 x 110	69	61	8	A	300	R RC1.125L
140 x 90	76	51	25	B	315	R RC1.140I
140 x 110	76	61	15	B	460	R RC1.140L
140 x 125	76	69	7	B	330	R RC1.140M
160 x 110	86	61	25	A	795	R RC1.160L
160 x 125	86	69	17	B	715	R RC1.160M
160 x 140	86	76	10	B	710	R RC1.160N
200 x 160	106	76	30	A	2020	R RC1.2000
225 x 160	119	86	33	B	1840	R RC1.2250
225 x 200	119	106	13	A	1196	R RC1.225P
250 x 160	132	86	45	B	3100	R RC1.2500
250 x 200	132	106	25	A	3500	R RC1.250P
250 x 225	132	119	12	A	2100	R RC1.250Q
280 x 225	147	119	27	B	4300	R RC1.280Q
315 x 200	165	106	58	B	8650	R RC1.315P
315 x 225	165	119	45	B	8100	R RC1.315Q
315 x 250	165	131	33	B	5080	R RC1.315R
315 x 280	165	146	18	A	4590	R RC1.315S

> FITTINGS PLAIN

METRIC PVC-U FITTINGS

TY1 | TEE 45° PLAIN

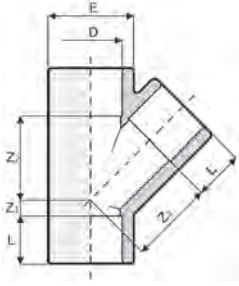

Size (D)	L	Z ₁	Z ₂	E	PVC-U	
					gms	Code
32	22	9	44	41	110	R TY1.0320
40	26	11	55	50	190	R TY1.0400
50	31	12	68	63	335	R TY1.0500
63	38	15	85	78	570	R TY1.0630

CR1 | CROSS PLAIN

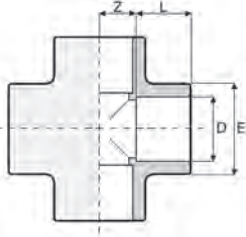

Size (D)	L	Z	E	PVC-U	
				gms	Code
25	19	14	35	60	R CR1.0250
32	22	18	43	105	R CR1.0320
40	26	23	52	175	R CR1.0400
50	31	27	64	265	R CR1.0500
63	38	33.5	79	505	R CR1.0630

RL1 | REDUCING PIECE MALE PLAIN/FEMALE PLAIN

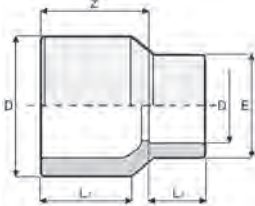
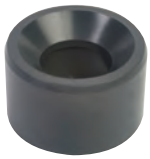

Size (DxD)	L ₁	L ₂	Z	E	PVC-U	
					gms	Code
160 x 110	86	61	100	129	1166	R RL1.160L

MR1 | REDUCING SOCKET PLAIN

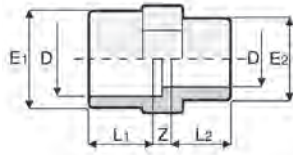

Fig A

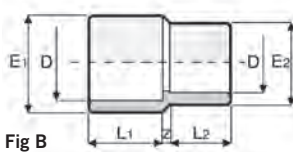
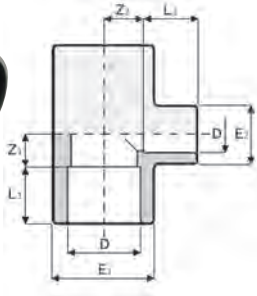

Fig B

Size (DxD)	L ₁	L ₂	Z	E ₁	E ₂	fig.	PVC-U	
							gms	Code
20 x 16	16	14	6	28	23	B	10	R MR1.020A
25 x 20	19	16	6	34	28	B	13	R MR1.025B
32 x 25	22	19	6	42	34	B	37	R MR1.032C
40 x 32	26	22	6	51	42	B	55	R MR1.040D
50 x 40	31	26	6	61	51	B	80	R MR1.050E
63 x 50	38	31	6	75	61	B	130	R MR1.063F
75 x 63	44	38	4	89	75	A	210	R MR1.075G
90 x 75	51	44	5	106	89	A	370	R MR1.090H
110 x 90	61	51	6	129	106	A	528	R MR1.110I
125 x 110	69	61	24	145	129	B	809	R MR1.125L
140 x 110	76	61	25	160	129	B	1166	R MR1.140L

TR1 | REDUCING TEE PLAIN



Size (DxD)	L ₁	L ₂	Z	E ₁	E ₂	fig.	PVC-U	
							gms	Code
20 x 16	16	14	11	11	28	23	30	R TR1.020A
25 x 16	19	14	14	14	34	23	45	R TR1.025A
25 x 20	19	16	14	14	34	28	45	R TR1.025B
32 x 16	22	14	17	17	42	23	65	R TR1.032A
32 x 20	22	16	17	17	42	28	65	R TR1.032B
32 x 25	22	19	17	17	42	34	65	R TR1.032C
40 x 16	26	14	21	21	51	23	105	R TR1.040A
40 x 20	26	16	21	21	51	28	110	R TR1.040B
40 x 25	26	19	21	21	51	34	110	R TR1.040C
40 x 32	26	22	21	21	51	42	110	R TR1.040D
50 x 20	31	16	26	26	61	28	170	R TR1.050B
50 x 25	31	19	26	26	61	34	170	R TR1.050C
50 x 32	31	22	26	26	61	42	170	R TR1.050D
50 x 40	31	26	26	26	61	51	170	R TR1.050E
63 x 25	38	19	33	33	75	34	275	R TR1.063C
63 x 32	38	22	33	33	75	42	275	R TR1.063D
63 x 40	38	26	33	33	75	51	280	R TR1.063E
63 x 50	38	31	33	33	75	61	280	R TR1.063F
75 x 32	44	22	39	39	89	42	455	R TR1.075D
75 x 40	44	26	39	39	89	51	455	R TR1.075E
75 x 50	44	31	39	39	89	61	460	R TR1.075F
75 x 63	44	38	39	39	89	75	470	R TR1.075G
90 x 40	51	26	47	47	106	51	715	R TR1.090E
90 x 50	51	31	47	47	106	61	720	R TR1.090F
90 x 63	51	38	47	47	106	75	725	R TR1.090G
90 x 75	51	44	47	47	106	89	750	R TR1.090H
110 x 50	61	31	57	57	129	61	1250	R TR1.110F
110 x 63	61	38	57	57	129	75	1303	R TR1.110G
110 x 75	61	44	57	57	129	89	1270	R TR1.110H
110 x 90	61	51	57	57	129	106	1315	R TR1.110I
160 x 110	86	61	82	57	187	131	3540	R TR1.160L

MA3 | SOCKET PLAIN/BSP THREADED

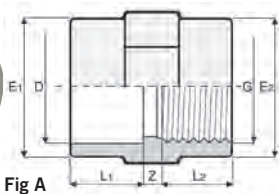

Fig A

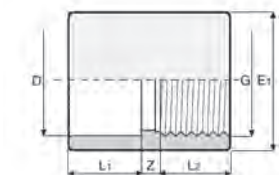
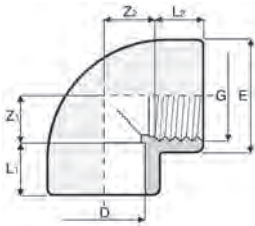

Fig B

Size (DxG)	L ₁	L ₂	Z	E ₁	E ₂	fig.	PVC-U	
							gms	Code
16 x 3/8"	14	11.4	6	23	23	A	10	R MA3.016A
20 x 1/2"	16	15	4	28	28	A	23	R MA3.020B
25 x 3/4"	19	16.3	5	35	35	A	34	R MA3.025C
32 x 1"	22	19.1	6	43	43	A	53	R MA3.032D
40 x 1 1/4"	26	21.4	8	51	51	B	60	R MA3.040E
50 x 1 1/2"	31	21.4	13	61	61	B	100	R MA3.050F
63 x 2"	38	25.7	8	76	76	A	190	R MA3.063G
75 x 2 1/2"	44	30.2	8	89	89	A	225	R MA3.075H
90 x 3"	51	33.3	9	106	103	A	355	R MA3.090I
110 x 4"	61	39.3	10	129	130	A	555	R MA3.110L

G03 | ELBOW 90° PLAIN/BSP THREADED



Size (DxG)	L ₁	L ₂	L ₃	E1	O	PVC-U	
						gms	Code
16 x 3/8"	14	11.4	9	11.6	23	25	R G03.016A
20 x 1/2"	16	15	11	12	28	25	R G03.020B
25 x 3/4"	19	16.3	14	17	35	40	R G03.025C
32 x 1"	22	19.1	18	20.5	43	72	R G03.032D
40 x 1 1/4"	26	21.4	21	25.6	51	95	R G03.040E
50 x 1 1/2"	31	21.4	26	35.6	61	165	R G03.050F
63 x 2"	38	25.7	33	46	76	320	R G03.063G
75 x 2 1/2"	44	30.2	39	52.8	89	417	R G03.075H
90 x 3"	51	33.3	47	64.7	106	690	R G03.090I
110 x 4"	61	39.3	57	78.7	129	1035	R G03.110L

T13 | TEE PLAIN/THREADED BRANCH

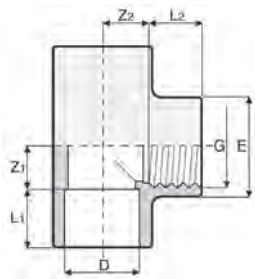

Size (DxG)	L ₁	L ₂	Z ₁	Z ₂	E	PVC-U	
						gms	Code
16 x 3/8"	14	11.4	9	11.6	23	40	R T13.016A
20 x 1/2"	16	15	12	13	28	32	R T13.020B
25 x 3/4"	19	16.3	15	17	35	52	R T13.025C
32 x 1"	22	19.1	18	21	43	71	R T13.032D
40 x 1 1/4"	26	21.4	21	25.6	51	125	R T13.040E
50 x 1 1/2"	31	21.4	26	35.6	61	200	R T13.050F
63 x 2"	38	25.7	33	45.3	75	380	R T13.063G
75 x 2 1/2"	44	30.2	39	52.8	89	530	R T13.075H
90 x 3"	51	33.3	47	64.7	106	845	R T13.090I
110 x 4"	61	39.3	57	78.7	129	1415	R T13.110L

AF3 | ADAPTOR PLAIN SPIGOT/BSP THREADED FEMALE

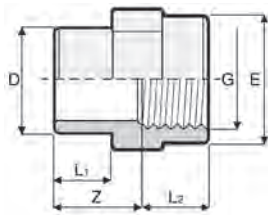

Size (DxG)	L ₁	L ₂	E	Z	PVC-U	
					gms	Code
20 x 1/2"	14	15	28	22	20	R AF3.020B
20 x 3/4"	16	15	28	26	30	R AF3.020C
25 x 1/2"	16	16.3	34	26	20	R AF3.025B
25 x 3/4"	16	19	28	29	30	R AF3.025C
25 x 1"	19	16.3	34	29	52	R AF3.025D
32 x 3/4"	19	19.1	42	29	30	R AF3.032C
32 x 1"	19	22	34	32	40	R AF3.032D
40 x 1"	22	19.1	42	33	50	R AF3.040D
40 x 1 1/4"	22	19.1	42	37	76	R AF3.040E
50 x 1 1/2"	31	21.4	51	42	100	R AF3.050F
50 x 2"	31	21.4	58	42	125	R AF3.050G
63 x 2"	38	25.7	72	50	140	R AF3.063G
75 x 2"	38	44	75	61	180	R AF3.075G
75 x 2 1/2"	44	30.2	89	59	188	R AF3.075H
75 x 3"	44	33.3	103	59	200	R AF3.075I
90 x 2 1/2"	44	51	89	68	249	R AF3.090H
90 x 3"	51	33.3	103	67	235	R AF3.090I
90 x 4"	51	39.3	130	67	456	R AF3.090L
110 x 3"	51	61	106	82	502	R AF3.110I
110 x 4"	61	39.3	130	77	490	R AF3.110L

AM3 | ADAPTOR PLAIN FEMALE/BSP THREADED MALE SPIGOT

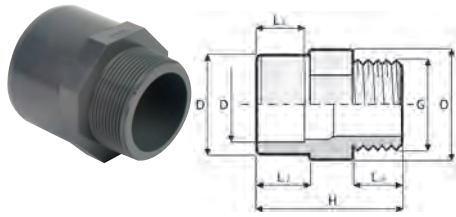

Size (DxDxG)	L ₁	L ₂	L ₃	H	O	PVC-U	
						gms	Code
12 x 16 x 3/8"	12	14	11.4	34.5	20.4	10	R AM3.012A
16 x 20 x 3/8"	14	16	11.4	40	24	10	R AM3.016A
16 x 20 x 1/2"	14	16	15	43	24	15	R AM3.016B
20 x 25 x 3/8"	16	19	11.4	43	30	19	R AM3.020A
20 x 25 x 1/2"	16	19	15	46	30	15	R AM3.020B
20 x 25 x 3/4"	16	19	16.3	47	30	20	R AM3.020C
25 x 32 x 1/2"	19	22	15	49	36	25	R AM3.025B
25 x 32 x 3/4"	19	22	16.3	50	36	25	R AM3.025C
25 x 32 x 1"	19	22	19.1	53	36	45	R AM3.025D
32 x 40 x 3/4"	22	26	16.3	54	46	40	R AM3.032C
32 x 40 x 1"	22	26	19.1	57	46	40	R AM3.032D
32 x 40 x 1 1/4"	22	26	21.4	60	46	55	R AM3.032E
40 x 50 x 1"	26	31	19.1	64	55	70	R AM3.040D
40 x 50 x 1 1/4"	26	31	21.4	67	55	70	R AM3.040E
40 x 50 x 1 1/2"	26	31	21.4	67	55	70	R AM3.040F
50 x 63 x 1 1/4"	31	38	21.4	74	65	70	R AM3.050E
50 x 63 x 1 1/2"	31	38	21.4	74	6	115	R AM3.050F
50 x 63 x 2"	31	38	25.7	78	65	125	R AM3.050G
63 x 75 x 1 1/2"	38	44	21.4	80	80	198	R AM3.063F
63 x 75 x 2"	38	44	25.7	84	80	160	R AM3.063G
63 x 75 x 2 1/2"	38	44	30.2	91	80	195	R AM3.063H
75 x 90 x 2"	44	51	25.7	94	95	270	R AM3.075G
75 x 90 x 2 1/2"	44	51	30.2	99	95	285	R AM3.075H
75 x 90 x 3"	44	51	33.3	102	95	285	R AM3.075I
90 x 110 x 2 1/2"	51	61	30.2	110	115	485	R AM3.090H
90 x 110 x 3"	51	61	33.3	113	115	490	R AM3.090I
90 x 110 x 4"	51	61	39.3	118	115	480	R AM3.090L
110 x 125 x 3"	61	66	33.3	115	130	490	R AM3.110I
110 x 125 x 4"	61	66	39.3	120	130	490	R AM3.110L

AS3 | METRIC PVC TANK CONNECTOR

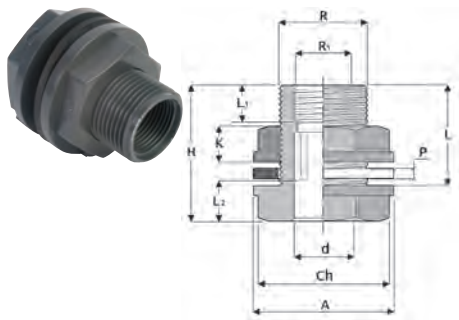

Size (RxdxR ₁)	A	Ch	L	L ₁	L ₂	H	P	K	Pk	PVC-U	
										gms	Code
3/4" x 16 x 1/2"	44	33	47	15	14	60.5	3	13.5	5	53	R AS3.016B
1" x 20 x 3/4"	58	46	49	16.3	16	65	3	16	5	108	R AS3.020C
1 1/4" x 25 x 1"	62	50	52	19.1	19	70	3	18	5	142	R AS3.025D
1 1/2" x 32 x 1"	76	60	54	19.1	22	73	3	19	-	192	R AS3.032D
2" x 40 x 1 1/2"	92	79	60	21.4	26	81	3	20.8	-	337	R AS3.040F

BO3 | UNION PLAIN/BSP THREADED

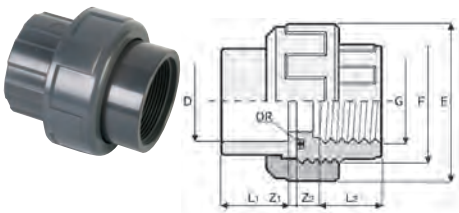

Size (DxG)	L ₁	L ₂	Z ₁	Z ₂	F	E	O R	Pn	PVC-U	
									gms	Code
16 x 3/8"	14	11.4	3	13.6	3/4"	34	3062	16	31	R BO3.016A
20 x 1/2"	16	15	3	11	1"	42	4081	16	42	R BO3.020B
25 x 3/4"	19	16.3	3	12.7	1 1/4"	52	4112	16	70	R BO3.025C
32 x 1"	22	19.1	3	12.9	1 1/2"	59	4125	16	96	R BO3.032D
40 x 1 1/4"	26	21.4	3	16.6	2"	72	6162	16	155	R BO3.040E
50 x 1 1/2"	31	21.4	3	23.6	2 1/4"	79	6187	16	237	R BO3.050F
63 x 2"	38	25.7	3	30.3	2 3/4"	96	6237	16	405	R BO3.063G
75 x 2 1/2"	45	30.2	3	32.8	3 1/2"	119	6312	10	560	R BO3.075H
90 x 3"	53	59.0	5	36.7	4"	134	6362	6	750	R BO3.090I
110 x 4"	61	69.0	5	40.7	5"	163	6450	6	1300	R BO3.110L

P03 | HOSE ADAPTOR BSP THREADED/METRIC

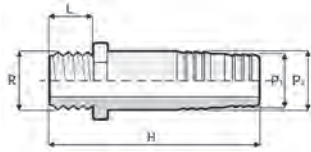

Size (RxP ₁ xP ₂)	L	H	PVC-U	
			gms	Code
3/8" x 16 x 18	11.4	58	14	R P03.016A
1/2" x 20 x 22	15	66	19	R P03.020B
3/4" x 25 x 27	16.3	81	30	R P03.025C
1" x 30 x 32	19.1	97	45	R P03.032D
1 1/4" x 40 x 42	21.4	104	85	R P03.040E
1 1/2" x 50 x 52	21.4	111	120	R P03.050F
2" x 60 x 64	25.7	123	180	R P03.063G

FB3 | COMPOSITE UNION FEMALE BSP THREAD

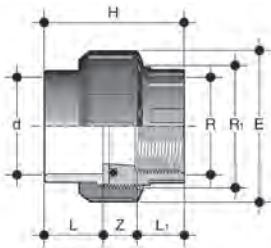

Size (dxR)	PN	L ₁	Z	L	H	K	PVC-U Code
16 x 3/8"	16	13.5	14	14	42.5	20	R FB3.016A
20 x 1/2"	16	16.5	16	16	48.5	25	R FB3.020B
25 x 3/4"	16	18.5	17	19	54.5	32	R FB3.025C
32 x 1"	16	19.5	18	22	59.5	38	R FB3.032D
40 x 1 1/4"	16	21.5	21	26	68.5	48	R FB3.040E
50 x 1 1/2"	16	23	24.5	31	84.5	55	R FB3.050F
63 x 2"	16	27	29.5	38	94.5	69	R FB3.063G

EPDM rubber seal. Stainless steel options also available on request.

MB3 | COMPOSITE UNION MALE BSP THREAD

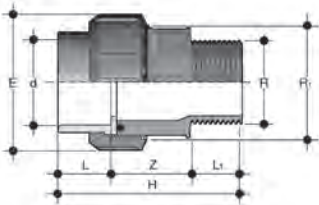

Size (dxR)	PN	L ₁	Z	L	H	K	PVC-U Code
16 x 3/8"	16	10.5	34	14	58.5	33	R FB3.016A
20 x 1/2"	16	13.5	35.5	16	65	41	R FB3.020B
25 x 3/4"	16	15	38.5	19	72.5	50	R FB3.025C
32 x 1"	16	17.5	40.5	22	80	58	R FB3.032D
40 x 1 1/4"	16	19.5	45.5	26	91	72	R FB3.040E
50 x 1 1/2"	16	19.5	50.5	31	101	79	R FB3.050F
63 x 2"	16	24	60.5	38	122.5	98	R FB3.063G

EPDM rubber seal. Stainless steel options also available on request.

BM3 | SOCKET UNION PLAIN/MALE THREADED

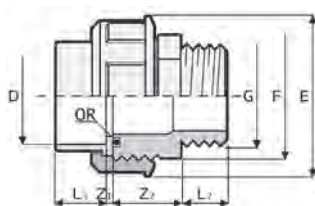

Size (DxG)	L ₁	L ₂	Z ₁	Z ₂	F	E	O-R	PVC-U	
								gms	Code
50 x 1 1/2"	31	28	3	41	2 1/4"	79	6187	270	R BM3.050F
50 x 2"	31	28	3	41	2 1/4"	79	6187	258	R BM3.050G
63 x 2"	38	28	3	43	2 3/4"	96	6237	406	R BM3.063G

RM3 | ADAPTOR PLAIN SPIGOT/THREADED WITH METAL REINFORCING RING

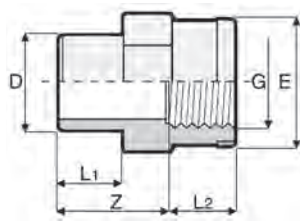

Size (DxG)	L ₁	L ₂	E	Z	PVC-U	
					gms	Code
20 x 1/2"	16	15	30	26	20	R RM3.020B
25 x 1/2"	16	19	30	29	20	R RM3.025B
25 x 3/4"	19	16.3	35	29	30	R RM3.025C
32 x 3/4"	19	22	35	32	30	R RM3.032C
32 x 1"	22	19.1	45	33	40	R RM3.032D
40 x 1"	22	20.6	45	37	50	R RM3.040D
40 x 1 1/4"	26	21.4	55	37	53	R RM3.040E
50 x 1 1/2"	31	21.4	65	42	100	R RM3.050F
50 x 2"	31	25.7	78	42	125	R RM3.050G
63 x 2"	38	25.7	78	50	140	R RM3.063G

MM3 | ADAPTOR PLAIN/THREADED WITH METAL REINFORCING RING

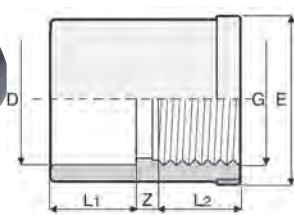

Size (DxG)	L ₁	L ₂	E	Z	PVC-U	
					gms	Code
16 x 3/8"	14	11.4	6	25	10	R MM3.016A
20 x 1/2"	16	15	4	30	15	R MM3.020B
25 x 3/4"	19	16.3	6	35	25	R MM3.025C
32 x 1"	22	19.1	6	45	40	R MM3.032D
40 x 1 1/4"	26	21.4	8	55	60	R MM3.040E
50 x 1 1/2"	31	21.4	13	65	100	R MM3.050F
63 x 2"	38	25.7	15	78	180	R MM3.063G

GM3 | ADAPTOR ELBOW PLAIN/THREADED WITH METAL REINFORCING RING

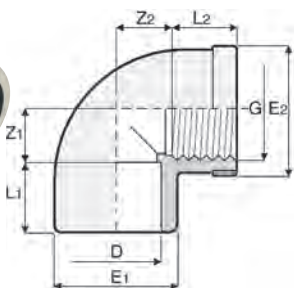

Size (DxG)	L ₁	L ₂	Z ₁	Z ₂	E ₁	E ₂	PVC-U	
							gms	Code
16 x 3/8"	14	11.4	9	11.6	23	25	25	R GM3.016A
20 x 1/2"	16	15	11	12	28	30	25	R GM3.020B
25 x 3/4"	19	16.3	14	16.7	34	35	25	R GM3.025C
32 x 1"	22	19.1	17	19.9	42	45	60	R GM3.032D
40 x 1 1/4"	26	21.4	21	25.6	51	55	95	R GM3.040E
50 x 1 1/2"	31	21.4	26	35.6	61	65	165	R GM3.050F
63 x 2"	38	25.7	33	45.3	75	78	280	R GM3.063G

TM3 | ADAPTOR TEE PLAIN/THREADED WITH METAL REINFORCING RING

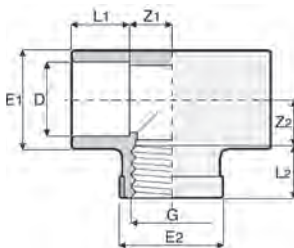

Size (DxG)	L ₁	L ₂	Z ₁	Z ₂	E ₁	E ₂	PVC-U	
							gms	Code
16 x 3/8"	14	11.4	9	11.6	23	25	35	R TM3.016A
20 x 1/2"	16	15	11	12	28	30	45	R TM3.020B
25 x 3/4"	19	16.3	14	16.7	34	35	55	R TM3.025C
32 x 1"	22	19.1	17	19.9	42	45	75	R TM3.032D
40 x 1 1/4"	26	21.4	21	25.6	51	55	125	R TM3.040E
50 x 1 1/2"	31	21.4	26	35.6	61	65	200	R TM3.050F
63 x 2"	38	25.7	33	45.3	75	78	330	R TM3.063G

> FLANGES

METRIC PVC-U FITTINGS

FF1 | FULL FACE FLANGE PN10/PN16

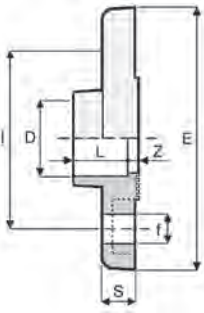

Size	DN	L	Z	E	I	f	S	N° drill	Bolts	PVC-U	
										gms	Code
20	15	16	4	95	65	14	11	4	M12x55	70	R FF1.0200
25	20	19	4	105	75	14	12	4	M12x60	87	R FF1.0250
32	25	22	4	115	85	14	14	4	M12x60	137	R FF1.0320
40	32	26	4	140	100	18	15	4	M16x70	237	R FF1.0400
50	40	31	5	150	110	18	16	4	M16x75	280	R FF1.0500
63	50	38	5	165	125	18	18	4	M16x80	395	R FF1.0630
75	65	44	6	185	145	18	19	8	M16x90	555	R FF1.0750
90	80	51	7	200	160	18	20	8	M16x90	780	R FF1.0900
110	100	61	8	220	180	18	22	8	M16x100	1070	R FF1.1100

QR1 | STUB FLANGE SERRATED FACE

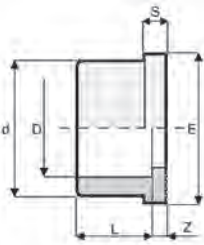
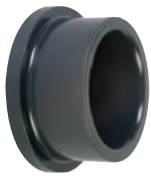

Size	L	Z	d	S	E	PVC-U	
						gms	Code
20	16	3	27	6	34	10	R QR1.0200
25	19	3	33	7	41	14	R QR1.0250
32	22	3	41	7	50	33	R QR1.0320
40	26	3	50	8	61	37	R QR1.0400
50	31	3	61	8	73	60	R QR1.0500
63	38	3	76	9	90	110	R QR1.0630
75	44	3	90	10	106	165	R QR1.0750
90	51	5	108	11	125	270	R QR1.0900
110	61	4	131	12	150	445	R QR1.1100
125	69	5	147	13	168	565	R QR1.1250
140	76	5	165	14	188	735	R QR1.1400
160	86	5	188	16	212	1250	R QR1.1600
200	106	7	232	16	254	2519	R QR1.2000
225	119	7	248	16	274	2570	R QR1.2250
250	131	9	274	20	308	3000	R QR1.2500
280	147	14.5	307	32	327	3650	R QR1.2800
315	165	16	346	32	377	4950	R QR1.3150

FC1 | BLANK FLANGE PN16

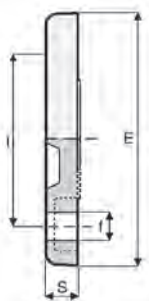

Size	DN	E	S	I	f	N° drill	Bolts	PVC-U	
								gms	Code
20	15	95	11	64	14	4	M12x55	99	R FC1.0200
25	20	105	12	76	14	4	M12x60	106	R FC1.0250
32	25	115	14	86	14	4	M12x60	206	R FC1.0320
40	32	141	15	100	18	4	M16x70	295	R FC1.0400
50	40	150	16	111	18	4	M16x75	327	R FC1.0500
63	50	165	18	126	18	4	M16x80	358	R FC1.0630
75	65	185	19	145	18	4	M16x90	444	R FC1.0750
90	80	200	20	160	18	8	M16x90	570	R FC1.0900
110	100	220	22	180	18	8	M16x100	766	R FC1.1100
160	150	286	26	240	22	8	M16x100	2100	R FC1.1600

FL1 | LOOSE FLANGE PN16

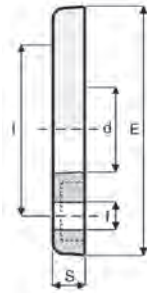

Size	DN	d	E	S	I	f	No. of Holes	Bolts	PVC-U	
									gms	Code
20	15	28	95	11	65	14	4	M12x55	70	R FL1.0200
25	20	34	105	12	75	14	4	M12x60	80	R FL1.0250
32	25	42	115	14	85	14	4	M12x60	116	R FL1.0320
40	32	51	140	15	100	18	4	M16x70	180	R FL1.0400
50	40	62	150	16	110	18	4	M16x75	215	R FL1.0500
63	50	78	165	18	125	18	4	M16x80	295	R FL1.0630
75	65	92	185	19	145	18	4	M16x90	455	R FL1.0750
90	80	110	203	20	160	18	8	M16x90	460	R FL1.0900
110	100	132	222	22	180	18	8	M16x100	515	R FL1.1100
125	110	149	230	24	190	18	8	M16x100	724	R FL1.1250
140	125	167	250	26	210	18	8	M16x110	813	R FL1.1400
160	150	190	285	28	240	22	8	M20x120	1285	R FL1.1600
200	200	235	341	30	285	22	8	M20x120	1930	R FL1.2000
225	200	244	341	30	285	22	12	M20x140	1950	R FL1.225N
250*	250	281	395	33	350	22	12	M20x140	2780	R FL1.2500
280*	250	309	396	35	350	22	12	M20x160	3010	R FL1.2800
315*	300	349	465	40	400	22	12	M20x180	3050	R FL1.3150

*PN10 drilling

GF1 | FULL FACE GASKET PN16

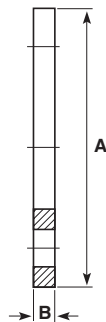

Size	A	B	P.C.D.	No. of Holes	Hole Dia.	gms	Code
20	95	3	65	4	14	31	E GFN.0200
25	112	3	75	4	14	37	E GFN.0250
32	115	3	85	4	14	37	E GFN.0320
40	121	3	100	4	18	41	E GFN.0400
50	133	3	110	4	18	55	E GFN.0500
63	153	3	125	4	18	56	E GFN.0630
75	184	3	160	8	18	98	E GFN.0750
90	216	3	180	8	18	112	E GFN.0900

GQP | STUB FLANGE GASKET

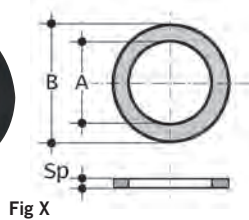
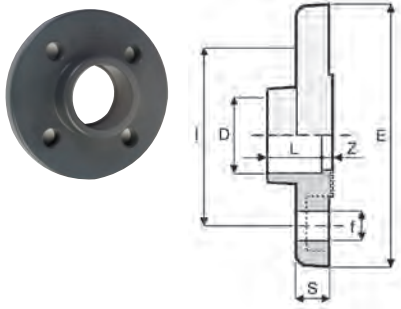

Fig X

Size	A	B	Sp	gms	Code
20	20	32	2	2	E GQP.0200
25	25	39	2	3	E GQP.0250
32	32	48	2	4	E GQP.0320
40	40	59	2	4	E GQP.0400
50	50	71	2	5	E GQP.0500
63	63	88	2	10	E GQP.0630
75	75	104	2	20	E GQP.0750
90	90	123	2	30	E GQP.0900
110	110	148	3	40	E GQP.1100
125	125	167	3	50	E GQP.1250
140	140	186	3	60	E GQP.1400
160	160	211	3	70	E GQP.1600
200	197	267	3	120	E GQP.2000
225	220	270	3	165	E GQP.2250
250	250	305	4	170	E GQP.2500

FF1 | FULL FACE FLANGE PN10/PN16



Size	DN	L	Z	E	I	f	S	N°	Bolts drill	PVC-U	
										gms	Code
20	15	16	4	95	65	14	11	4	M12x55	70	R FF1.0200
25	20	19	4	105	75	14	12	4	M12x60	87	R FF1.0250
32	25	22	4	115	85	14	14	4	M12x60	137	R FF1.0320
40	32	26	4	140	100	18	15	4	M16x70	237	R FF1.0400
50	40	31	5	150	110	18	16	4	M16x75	280	R FF1.0500
63	50	38	5	165	125	18	18	4	M16x80	395	R FF1.0630
75	65	44	6	185	145	18	19	8	M16x90	555	R FF1.0750
90	80	51	7	200	160	18	20	8	M16x90	780	R FF1.0900
110	100	61	8	220	180	18	22	8	M16x100	1070	R FF1.1100

BR1 | BACKING RINGS PN16/PN10

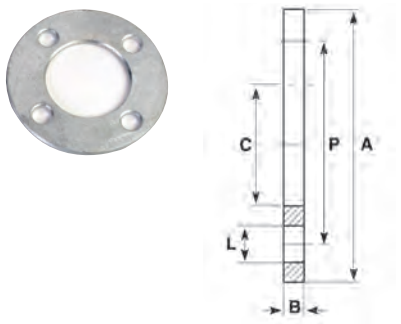

Size	A	B	C	P	L	No. Holes	Code	PVC-U	
								gms	Code
20	95	6	28	65	14	4	13	330	G BR1.0200
25	105	6	34	75	14	4	13	380	G BR1.0250
32	115	6	42	85	14	4	13	440	G BR1.0320
40	140	6	51	100	18	4	13	660	G BR1.0400
50	150	6	62	110	18	4	13	730	G BR1.0500
63	165	8	78	125	18	4	13	1100	G BR1.0630
75	185	8	92	145	18	4	13	1340	G BR1.0750
90	200	8	110	160	18	8	13	1500	G BR1.0900
110	220	8	133	180	18	8	13	1630	G BR1.1100
125	250	8	150	210	18	8	13	2090	G BR1.1125
140	250	10	167	210	18	8	13	2290	G BR1.1140
160	285	10	190	240	22	8	13	3050	G BR1.1600

Drilled to DIN 2501 (BS4504) PN10

Size	A	B	C	P	L	No. Holes	Code	PVC-U	
								gms	Code
200*	340	11	235	295	22	8		3190	13 421 318
225	340	11	249	295	22	8		3540	13 421 319
250	396	20	278	350	22	12		7330	13 421 320
315	448	20	355	402	22	12		9900	13 421 323

Drilled to DIN 2501 (BS4504) PN16

Size	A	B	C	P	L	No. Holes	Code	PVC-U	
								gms	Code
200*	340	11	235	295	22	12		3190	13 420 318
225	340	11	249	295	22	12		3540	13 420 319
250	405	20	278	355	26	12		7330	13 420 320
315	460	20	355	410	26	12		9900	13 420 323

BR4A | BACKING RING GALVANISED MILD STEEL DRILLED ANSI 150

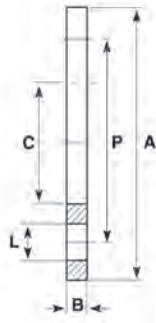

Size	OD (A)	ID (C)	Thickness (B)	PCD (P)	No. Holes	Size of bolt holes (L)	gms	Code
20	90	28	8	61	4	16	330	G BR4.020A
25	100	34	8	70	4	16	380	G BR4.025A
32	110	42	8	79	4	16	440	G BR4.032A
40	118	51	8	90	4	16	660	G BR4.040A
50	129	63	8	99	4	16	730	G BR4.050A
63	154	78	10	121	4	19	1100	G BR4.063A
75	178	92	8	140	4	19	1340	G BR4.075A
90	192	110	11	153	4	19	1500	G BR4.090A
110	230	133	11	190	8	19	1630	G BR4.110A
140	254	167	10	216	8	22	2290	G BR4.140A
160	279	196	10	241	8	22	3050	G BR4.160A
225	343	250	15	298	8	22	3540	G BR4.225A

724E | DOUBLE UNION BALL VALVE PLAIN WITH EPDM SEALS



Fig A

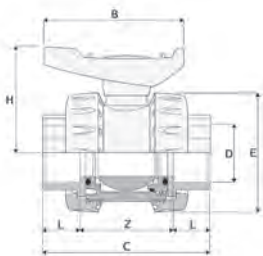
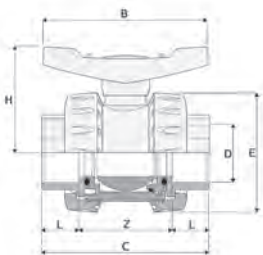

Fig B



Size	DN	L	Z	C	E	H	B	Ref	PVC-U	
									gms	Code
20	15	16	50	82	53	51	66	A	145	M 724.0200
25	20	19	53	91	62	59	77	A	220	M 724.0250
32	25	22	59	103	71	66	88	A	315	M 724.0320
40	32	26	68	120	84	77	102	A	505	M 724.0400
50	40	31	77	139	98	87	117	A	725	M 724.0500
63	50	38	98	174	117	105	140	A	1245	M 724.0630
75	65	44	142	230	168	151	212	B	3400	M 724.0750
90	80	51	142	244	168	151	212	B	3500	M 724.0900
110	100	61	162	284	210	178	212	B	5900	M 724.1100

Please note when using the 724 ball valve for end load resistance, please ensure the ball seat carrier is facing upstream. Refer to the markings on the valve body for indication.

724F | IMPERIAL DOUBLE UNION BALL VALVE PLAIN WITH FPM SEALS



Fig A

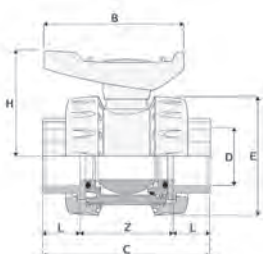
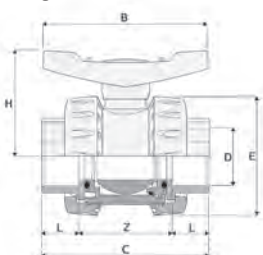

Fig B



Size	DN	L	Z	C	E	H	B	Ref	PVC-U	
									gms	Code
20	15	16	50	82	53	51	66	A	145	M 724.020F
25	20	19	53	91	62	59	77	A	220	M 724.025F
32	25	22	59	103	71	66	88	A	315	M 724.032F
40	32	26	68	120	84	77	102	A	505	M 724.040F
50	40	31	77	139	98	87	117	A	725	M 724.050F
63	50	38	98	174	117	105	140	A	1245	M 724.063F
75	65	44	142	230	168	151	212	B	3400	M 724.075F
90	80	51	142	244	168	151	212	B	3500	M 724.090F
110	100	61	162	284	210	178	212	B	5900	M 724.110F

Please note when using the 724 ball valve for end load resistance, please ensure the ball seat carrier is facing upstream. Refer to the markings on the valve body for indication.

322E | DOUBLE UNION BALL VALVE PLAIN WITH EPDM SEALS

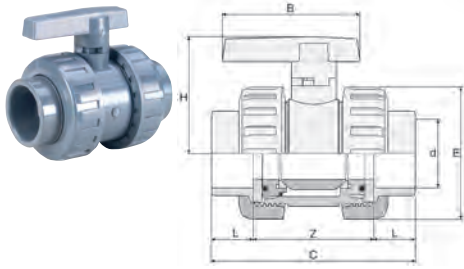

Size	DN	L	Z	C	E	H	B	PVC-U	
								gms	Code
16	10	14	47	75	50	50	57	120	M 322.0160
20	15	17	47	81	50	50	57	125	M 322.0200
25	20	19	57	95	59	55	66	205	M 322.0250
32	25	22	61	105	68	63	75	300	M 322.0320
40	32	26	72	124	80	76	90	440	M 322.0400
50	40	31	84	146	96	88	103	710	M 322.0500
63	50	38	96	172	116	102	121	1110	M 322.0630
75	65	44	170	258	196	151	212	3060	M 322.0750
90	80	51	170	272	196	151	212	3110	M 322.0900
110	100	61	193	315	239	178	212	5550	M 322.1100

Please note the 322 valve is not recommended for end load resistance.

M930 | 3-WAY BALL VALVE PLAIN EPDM SEALS

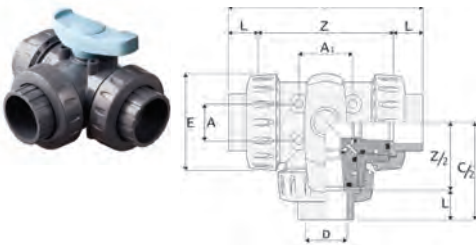

Size	DN	H	B	E	L	Z	C	H1	A1	A	PVC-U	
											gms	Code
20	15	52	66	53	16	76	108	27.5	24	24	245	M 930.0200
25	20	61	77	62	19	90	128	32.5	31	25	385	M 930.0250
32	25	68	88	71	22	100	144	36.5	40	27	560	M 930.0320
40	32	76	102	84	26	121	173	43	41	32	875	M 930.0400
50	40	91	117	98	31	135	197	51.5	53	28	1290	M 930.0500
63	50	107	140	117	38	167	243	59.5	58	35	2085	M 930.0630

M800 | BUTTERFLY VALVE EPDM SEALS

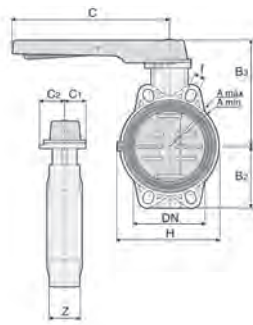

Size	DN	B ₂	B ₃	C	C ₁	C ₂	H	Z	A	A	F	No. Holes	PVC-U	
													gms	Code
50	40	60	136	175	45	42	132	33	93	109	19	4	827	M 800.0500
63	50	70	143	175	45	42	147	43	108	124	19	4	1012	M 800.0630
75	65	80	168	250	45	53	165	46	128	144	19	4	1420	M 800.0750
90	80	90	182	250	45	53	130	49	145	159	19	4	1640	M 800.0900
110	100	105	196	250	45	53	150	56	165	190	19	4	1990	M 800.1100
140	125	121	215	355	45	53	185	64	204	215	23	4	3030	M 800.1400
160	150	132	229	355	45	53	210	70	230	242	23	4	3730	M 800.1600
225	200	161	309	425	65	82	325	71	280	298	23	8	8240	M 800.2250

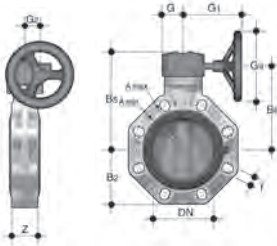

Size	DN	B ₂	B ₅	B ₆	G	G ₁	G ₂	G ₃	Z	A	A	F	No. Holes	PVC-U	
														gms	Code
280	250	210	317	281	88	236	76	250	114	335	362	25	12	18600	M 800.2800
315	300	245	374	338	88	236	76	250	114	390	432	29	12	25600	M 800.3150

Note: Lugged option available

21NE | DOUBLE UNION BALL NON RETURN PLAIN WITH EPDM SEALS

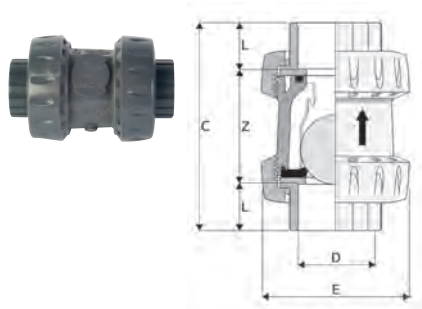

Size	DN	L	Z	C	E	PVC-U	
						gms	Code
20	15	16	50	82	53	105	M 21N.0200
25	20	19	53	91	62	150	M 21N.0250
32	25	22	59	103	71	250	M 21N.0320
40	32	26	68	120	84	370	M 21N.0400
50	40	31	77	139	98	590	M 21N.0500
63	50	38	98	174	117	990	M 21N.0630

Note: FPM seals options available

21AE | DOUBLE UNION AIR RELEASE VALVE PLAIN EPDM SEALS

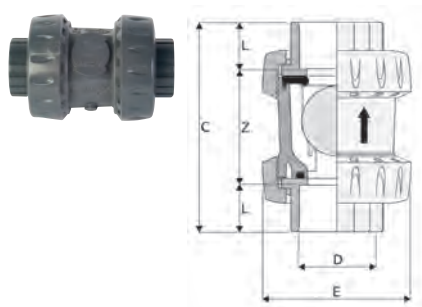

Size	DN	L	Z	C	E	PVC-U	
						gms	Code
20	15	16	50	82	53	100	M 21A.0200
25	20	19	53	91	62	140	M 21A.0250
32	25	22	59	103	71	230	M 21A.0320
40	32	26	68	120	84	350	M 21A.0400
50	40	31	77	139	98	560	M 21A.0500
63	50	38	98	174	117	950	M 21A.0630

Note: FPM seals options available

230 | DOUBLE UNION SPRING CHECK VALVE PLAIN EPDM SEALS

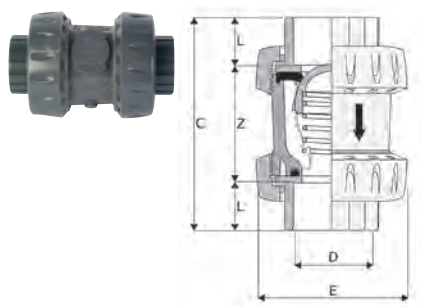

Size	DN	L	Z	C	E	PVC-U	
						gms	Code
20	15	16	50	82	53	105	M 230.0200
25	20	19	53	91	62	150	M 230.0250
32	25	22	59	103	71	250	M 230.0320
40	32	26	68	120	84	370	M 230.0400
50	40	31	77	139	98	590	M 230.0500
63	50	38	98	174	117	990	M 230.0630

Note: FPM seals options available

CLP | WAFER CHECK VALVE



Size	DN	De	Z	Di	A	B	C	A		B	PVC-U	
								Bar	Bar		gms	Code
50	40	95	16	21	72	25	28	0.001	0.004	0.3	160	M CLP.0500
63	50	109	20	32	86	37	29	0.001	0.004	0.4	250	M CLP.0630
75	65	129	20	40	105	50	31	0.001	0.004	0.3	320	M CLP.0750
90	80	144	20	54	119	61	32	0.001	0.007	0.2	390	M CLP.0900
110	100	164	22	70	146	77	31	0.001	0.007	0.2	550	M CLP.1100
140	125	195	23	92	173	94	35	0.001	0.007	0.3	750	M CLP.1400
160	150	220	25	112	197	115	35	0.001	0.007	0.1	1100	M CLP.1600
225	200	275	35	154	225	152	38	0.001	0.012	0.1	2100	M CLP.2250
280	250	330	40	192	312	180	41	0.001	0.012	0.1	3500	M CLP.2800
315	300	380	45	227	363	215	41	0.001	0.012	0.1	5300	M CLP.3150

Note: FPM seals options available

A - Minimum pressure for valve opening
B - Minimum pressure for seal

334E | DOUBLE UNION BALL VALVE WITH COMPRESSION ENDS

MTO

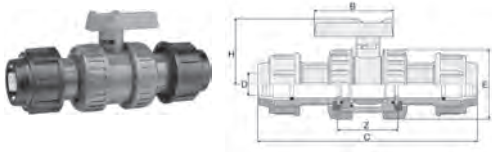

Size	DN	C	E	H	B	Z	PVC-U	
							gms	Code
20	15	175	50	50	57	74	193	M 334.0200
25	20	195	59	55	66	85	292	M 334.0250
32	25	212	68	63	75	85	450	M 334.0320

335E | SINGLE UNION BALL VALVE WITH COMPRESSION ENDS

MTO

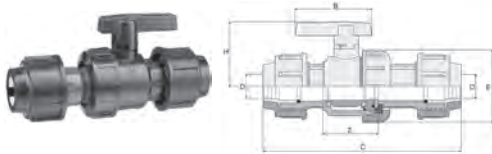

Size	DN	C	E	H	B	Z	PVC-U	
							gms	Code
20	15	148	50	50	57	67	156	M 335.0200
25	20	165	59	55	66	77	235	M 335.0250
32	25	188	68	63	75	83	365	M 335.0320

326M | DOUBLE UNION BALL VALVE WITH PE SPIGOT ENDS

MTO

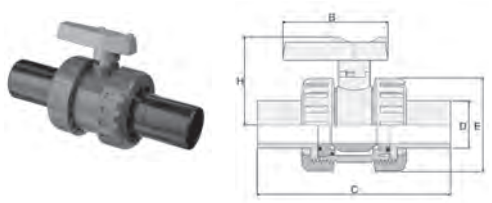

Size	DN	C	E	H	B	PVC-U	
						gms	Code
20	15	152	50	50	57	125	M.326.0200
25	20	192	59	55	66	215	M.326.0250
32	25	201	68	66.5	75	320	M.326.0320
40	32	220	80	79.5	90	460	M.326.0400
50	40	246	96	93	103	740	M.326.0500
63	50	272	116	107	121	1150	M.326.0630

Dimensional data is available upon request. Please contact our valve department on 01543 471681

AQP/APP | PNEUMATIC ACTUATED BALL VALVE SPRING RETURN EPDM SEALS



Size	PVC-U Fail Safe Open	PVC-U Fail Safe Close
20	AQPM0200	APPM0200
25	AQPM0250	APPM0250
32	AQPM0320	APPM0320
40	AQPM0400	APPM0400
50	AQPM0500	APPM0500
63	AQPM0630	APPM0630

ARP | PNEUMATIC ACTUATED BALL VALVE DOUBLE ACTING EPDM SEALS



Size	PVC-U Double Acting
20	ARPM0200
25	ARPM0250
32	ARPM0320
40	ARPM0400
50	ARPM0500
63	ARPM0630

AQP/APP | PNEUMATIC ACTUATED BUTTERFLY VALVE SPRING RETURN EPDM SEALS



Size	PVC-U Fail Safe Open	PVC-U Fail Safe Close
2½"/75mm	AQPB0750	APPB0750
3"/90mm	AQPB0900	APPB0900
4"/110mm	AQPB1100	APPB1100
5"/140mm	AQPB1400	APPB1400
6"/160mm	AQPB1600	APPB1600
8"/225mm	AQPB2250	APPB2250

ARP/APP | PNEUMATIC ACTUATED BUTTERFLY VALVE DOUBLE ACTING EPDM SEALS



Size	PVC-U Double Acting
2½"/75mm	ARPB0750
3"/90mm	ARPB0900
4"/110mm	ARPB1100
5"/140mm	ARPB1400
6"/160mm	ARPB1600
8"/225mm	ARPB2250

A1P/A2P | ELECTRIC ACTUATED BALL VALVE EPDM SEALS



Size	PVC-U	PVC-U
	110V/220V AC	24V DC
20	A1PM0200	A2PM0200
25	A1PM0250	A2PM0250
32	A1PM0320	A2PM0320
40	A1PM0400	A2PM0400
50	A1PM0500	A2PM0500
63	A1PM0630	A2PM0630

VALVE ACTUATOR KIT



Size (DN)	Mounting	Code
15	F04	HZMK1102
20	F04	HZMK1103
32	F04	HZMK1104
15	F05	HZMK2102
20	F05	HZMK2103
32	F05	HZMK2104
40	F05	HZMK2105
50	F05	HZMK2106
63	F05	HZMK2107
50	F07	HZMK3106
63	F07	HZMK3107

NOTE: Kit includes; mounting plate, mounting legs, drive shaft, 4 x screws, 1 x mounting screw & 6 x washers

ST1 | PIPE BRACKET (PP)

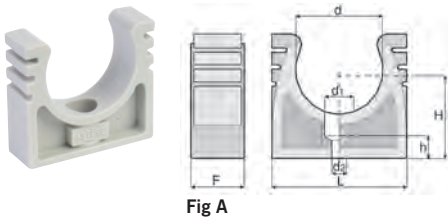

Size	H	L	d2	d1	h	F	Fig.	Pk	PVC-U	
									gms	Code
16	22.9	28	5.5	10.5	7.5	16	A	10	6	P ST1.0160
20	25	33	5.5	10.5	7.5	16	A	10	7	P ST1.0200
25	27.5	38	5.5	10.5	7.5	16	A	10	9	P ST1.0250
32	31	48	5.5	10.5	7.5	16	A	10	13	P ST1.0320

*Also available in black PE

ST1 | PIPE BRACKET WITH STRAP

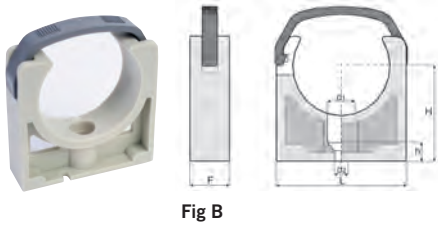

Size	H	L	d2	d1	h	F	Fig.	Pk	PVC-U	
									gms	Code
40	41.5	54	5.5	10.5	7.5	20	B	10	23	P ST1.0400
50	46.5	64.5	7	14	9	23	B	10	29	P ST1.0500
63	56	80	7	14	9	25	B	10	39	P ST1.0630
75	63.6	94	9	17	10.5	27.5	B	10	55	P ST1.0750
90	72	115	9	17	13.5	30	B	10	85	P ST1.0900
110	83.8	139	9	17	14	30	B	10	100	P ST1.1100

*Also available in black PE

>ACCESSORIES

METRIC PVC-U ACCESSORIES

PCO | PVC-U SOLVENT CEMENT



Size	Code
1/2 litre	R PCO.0200

N.B. Accessory discount applies to this item

PCO | PVC-U RH (THF FREE) SOLVENT CEMENT



Size	Code
1/2 litre	R PCO.0300

N.B. Accessory discount applies to this item

CFO | ECO CLEANER



Size	Code
1/2 litre	S ACO.0200

N.B. Accessory discount applies to this item

PCO | PVC-U HCR CHEMICAL RESISTANT SOLVENT CEMENT



Size	Code
1 litre	R PCO.0100

N.B. Accessory discount applies to this item

CFO | CHEMICAL RESISTANT CLEANER



Size	Code
1/2 litre	M CFO.0100

N.B. Accessory discount applies to this item

CHAMFERRING TOOLS



Size	Code
16-63mm chamfering tool	C AF0.0100



32-160mm chamfering tool	C AF0.0102
--------------------------	------------

PIPE CUTTER



Size	Code
16-63mm	T TF0.0100
50-125mm	T TF0.0101
16-63mm spare cutter wheel	T TF0.0102
50-125mm spare cutter wheel	T TF0.0103

FIBRESEAL (Sealing tape for threaded connections)



Description	Code
Fibre seal tape	F AF0.0100

CLAMP SADDLES

Astore clamp saddles are the ideal solution for branching from existing pipelines for water and irrigation.

RANGE

Astore clamp saddles are supplied in the following types:

- 505 single branch. Coupling with pipes from D 20 up to D 315 mm, threaded branches from 1/2" to 4". Provided with 2, 4 or 6 bolts according to the diameters and metal reinforcing ring on the threaded branches.
- 508 double branch. Coupling with pipes from D 20 up to D 315 mm, threaded branches from 1/2" to 4".

Provided with 2, 4 or 6 bolts according to the diameters and metal reinforcing ring on the threaded branches.

MATERIALS

Saddle body in PP black co-polymer, nuts and bolts in zinc chromed steel, O-ring gasket in NBR, reinforcing ring in AISI 430.

STANDARDS

Threads following DIN 2999 - BS 21 - ISO R 7/1 up to D 160 mm, ISO 228 from D 180 to D 315 mm.

Coupling to pipes complying:

- PE metric sized according to UNI 10910, DIN 8072-8074, ISO 3607 and UNI EN 12201.
- PVC metric sized according to ISO 161, UNI EN 1452, BRL-K502.
- PP metric sized according to ISO 3609, UNI 8318, DIN 8077.

PRESSURE RATING

505 and 508 - see table below.



505 | WORKING PRESSURE AT 20°C ACCORDING TO ISO 13460

D x G	1/2"	3/4"	1"	1 1/4"	1 1/2"	2"	2 1/2"	3"	4"
20	10 BAR								
25	10 BAR	10 BAR							
32	10 BAR	10 BAR	10 BAR						
40	10 BAR	10 BAR	10 BAR						
50	10 BAR	10 BAR	10 BAR						
63	10 BAR	10 BAR	10 BAR	10 BAR	10 BAR				
75	10 BAR	10 BAR	10 BAR	10 BAR	10 BAR	10 BAR			
90	10 BAR	10 BAR	10 BAR	10 BAR	10 BAR	10 BAR			
110	10 BAR	10 BAR	10 BAR	10 BAR	10 BAR	10 BAR		6 BAR	
125		10 BAR	10 BAR	10 BAR	10 BAR	10 BAR			
140			10 BAR	10 BAR	10 BAR	10 BAR	6 BAR	6 BAR	
160		10 BAR	10 BAR	10 BAR	10 BAR	10 BAR		6 BAR	
180				6 BAR	6 BAR	6 BAR		6 BAR	6 BAR
200				6 BAR	6 BAR	6 BAR		6 BAR	6 BAR
225				4 BAR	4 BAR	4 BAR		4 BAR	4 BAR
250				4 BAR	4 BAR	4 BAR		4 BAR	4 BAR
280				4 BAR	4 BAR	4 BAR		4 BAR	4 BAR
315				4 BAR	4 BAR	4 BAR		4 BAR	4 BAR

>CLAMP SADDLES WITH STAINLESS STEEL REINFORCING RING

505 | CLAMP SADDLE WITH 2 BOLTS

MTO



Size	L	Z	E	H	No.	Bolts	Pack	gms	Code
20 x 1/2"	17	16	62	37.5	2	M6x35	150	56	P.505.020B
25 x 1/2"	18.5	18.5	69	43	2	M6x35	120	67	P.505.025B
25 x 3/4"	18.5	18.5	69	43	2	M6x35	120	71	P.505.025C
32 x 1/2"	18.5	22.5	78	45	2	M8x45	100	99	P.505.032B
32 x 3/4"	18.5	22.5	78	45	2	M8x45	100	103	P.505.032C
32 x 1"	18.5	22.5	91	60	2	M8x45	60	138	P.505.032D
40 x 1/2"	22	27	84	51	2	M8x45	60	119	P.505.040B
40 x 3/4"	22	27	84	51	2	M8x45	60	125	P.505.040C
40 x 1"	22	27	84	51	2	M8x45	60	132	P.505.040D
50 x 1/2"	22	32.5	87	53	2	M8x45	50	119	P.505.050B
50 x 3/4"	22	32.5	87	53	2	M8x45	50	123	P.505.050C
50 x 1"	22	32.5	87	53	2	M8x45	50	132	P.505.050D

505 | CLAMP SADDLE WITH 4 BOLTS

MTO

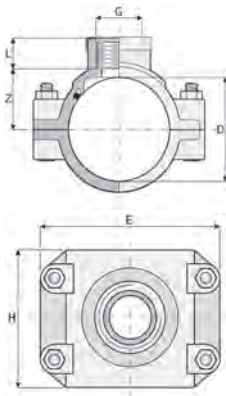

Size	L	Z	E	H	No.	Bolts	Pack	gms	Code
63 x 1/2"	17	40	100	71	4	M8x50	75	237	P.505.063B
63 x 3/4"	20	40	100	71	4	M8x50	75	244	P.505.063C
63 x 1"	22	40	100	71	4	M8x50	75	249	P.505.063D
63 x 1 1/4"	24	40	100	71	4	M8x50	70	260	P.505.063E
63 x 1 1/2"	24	40	100	71	4	M8x50	70	267	P.505.063F
75 x 1/2"	17	44.5	120	91	4	M8x50	50	312	P.505.075B
75 x 3/4"	20	44.5	120	91	4	M8x50	50	319	P.505.075C
75 x 1"	22	44.5	120	91	4	M8x50	50	329	P.505.075D
75 x 1 1/4"	24	44.5	120	91	4	M8x50	45	360	P.505.075E
75 x 1 1/2"	24	44.5	120	91	4	M8x50	45	342	P.505.075F
75 x 2"	26	44.5	120	91	4	M8x50	45	346	P.505.075G
90 x 1/2"	17	52	137	91	4	M8x60	40	358	P.505.090B
90 x 3/4"	20	52	137	91	4	M8x60	40	360	P.505.090C
90 x 1"	22	52	137	91	4	M8x60	40	367	P.505.090D
90 x 1 1/4"	24	52	137	91	4	M8x60	35	370	P.505.090E
90 x 1 1/2"	24	52	137	91	4	M8x60	35	380	P.505.090F
90 x 2"	26	52	137	91	4	M8x60	35	390	P.505.090G
110 x 1/2"	17	65	155	98.5	4	M8x60	25	403	P.505.110B
110 x 3/4"	20	65	155	98.5	4	M8x60	25	407	P.505.110C
110 x 1"	22	65	155	98.5	4	M8x60	25	417	P.505.110D
110 x 1 1/4"	24	65	155	98.5	4	M8x60	25	430	P.505.110E
110 x 1 1/2"	24	65	155	98.5	4	M8x60	25	438	P.505.110F
110 x 2"	24	65	155	98.5	4	M8x60	25	451	P.505.110G
110 x 3"	33	65	155	98.5	4	M8x60	20	537	P.505.110I
125 x 3/4"	20	73.5	168	101	4	M8x60	30	540	P.505.125C
125 x 1"	22	73.5	168	101	4	M8x60	30	543	P.505.125D
125 x 1 1/4"	24	73.5	168	101	4	M8x60	30	545	P.505.125E
125 x 1 1/2"	24	73.5	168	101	4	M8x60	30	548	P.505.125F
125 x 2"	24	73.5	168	101	4	M8x60	30	552	P.505.125G

> continued

MTO = Made to Order (Please refer to our Terms & Conditions).

>CLAMP SADDLES WITH STAINLESS STEEL REINFORCING RING

505 | CLAMP SADDLE WITH 6 BOLTS

MTO



Size	L	Z	E	H	No.	Bolts	Pack	gms	Code
140 x 1"	22	80	189	134	6	M8x60	20	921	P.505.140D
140 x 1¼"	24	80	189	134	6	M8x60	20	923	P.505.140E
140 x 1½"	24	80	189	134	6	M8x60	20	926	P.505.140F
140 x 2"	24	80	189	134	6	M8x60	20	930	P.505.140G
140 x 2½"	24	80	189	134	6	M8x60	20	937	P.505.140H
140 x 3"	33	80	189	134	6	M8x60	20	944	P.505.140I
160 x ¾"	22	88	213	137	6	M8x60	16	987	P.505.160C
160 x 1"	22	88	213	137	6	M8x60	1	991	P.505.160D
160 x 1¼"	24	88	213	137	6	M8x60	1	994	P.505.160E
160 x 1½"	24	88	213	137	6	M8x60	1	996	P.505.160F
160 x 2"	28.5	88	213	137	6	M8x60	1	1000	P.505.160G
160 x 3"	36	88	213	137	6	M8x60	1	1014	P.505.160I
180 x 1¼"	24	115	265	171	6	M10x80	1	2289	P.505.180E
180 x 1½"	24	115	265	171	6	M10x80	1	2292	P.505.180F
180 x 2"	24	115	265	171	6	M10x80	1	2296	P.505.180G
180 x 3"	33	115	265	171	6	M10x80	1	2310	P.505.180I
180 x 4"	42	115	265	171	6	M10x80	1	2314	P.505.180L
200 x 1¼"	24	115	265	171	6	M10x80	1	2019	P.505.200E
200 x 1½"	24	115	265	171	6	M10x80	1	2022	P.505.200F
200 x 2"	24	115	265	171	6	M10x80	1	2026	P.505.200G
200 x 3"	33	115	265	171	6	M10x80	1	2040	P.505.200I
200 x 4"	42	115	265	171	6	M10x80	1	2044	P.505.200L
225 x 1¼"	24	127.5	280	173	6	M10x80	1	2165	P.505.225E
225 x 1½"	24	127.5	280	173	6	M10x80	1	2145	P.505.225F
225 x 2"	24	127.5	280	173	6	M10x80	1	2155	P.505.225G
225 x 3"	33	127.5	280	173	6	M10x80	1	2180	P.505.225I
225 x 4"	42	127.5	280	173	6	M10x80	1	2210	P.505.225L
250 x 1¼"	24	142	313	181	6	M10x80	1	2545	P.505.250E
250 x 1½"	24	142	313	181	6	M10x80	1	2548	P.505.250F
250 x 2"	224	142	313	181	6	M10x80	1	2552	P.505.250G
250 x 3"	33	142	313	181	6	M10x80	1	2566	P.505.250I
250 x 4"	42	142	313	181	6	M10x80	1	2570	P.505.250L
280 x 1¼"	24	171	385	190	6	M10x80	1	4069	P.505.280E
280 x 1½"	24	171	385	190	6	M10x80	1	4072	P.505.280F
280 x 2"	24	171	385	190	6	M10x80	1	4076	P.505.280G
280 x 3"	33	171	385	190	6	M10x80	1	4090	P.505.280I
280 x 4"	42	171	385	190	6	M10x80	1	4094	P.505.280L
315 x 1¼"	24	171	385	190	6	M10x80	1	3168	P.505.315E
315 x 1½"	24	171	385	190	6	M10x80	1	3171	P.505.315F
315 x 2"	24	171	385	190	6	M10x80	1	3175	P.505.315G
315 x 3"	33	171	385	190	6	M10x80	1	3189	P.505.315I
315 x 4"	42	171	385	190	6	M10x80	1	3193	P.505.315L

MTO = Made to Order (Please refer to our Terms & Conditions).

>CLAMP SADDLES WITH STAINLESS STEEL REINFORCING RING

508 | DOUBLE CLAMP SADDLE WITH 2 BOLTS



Size	L	Z	E	H	No. Bolts	Bolts	Pack	gms	Code
20 x 1/2" x 1/2"	17	16	62	37.5	2	M6x35	1	61	P.508.020B
25 x 1/2" x 1/2"	18.5	18.5	69	43	2	M6x35	1	53	P.508.025B
25 x 3/4" x 3/4"	18.5	18.5	69	43	2	M6x35	1	79	P.508.025C
32 x 1/2" x 1/2"	18.5	22.5	78	45	2	M8x45	1	106	P.508.032B
32 x 3/4" x 3/4"	18.5	22.5	78	45	2	M8x45	1	114	P.508.032C
32 x 1" x 1"	18.5	22.5	91	60	2	M8x45	1	154	P.508.032D
40 x 1/2" x 1/2"	22	27	84	51	2	M8x45	1	132	P.508.040B
40 x 3/4" x 3/4"	22	27	84	51	2	M8x45	1	144	P.508.040C
40 x 1" x 1"	22	27	84	51	2	M8x45	1	156	P.508.040D
50 x 1/2" x 1/2"	22	32.5	87	53	2	M8x50	1	126	P.508.050B
50 x 3/4" x 3/4"	22	32.5	87	53	2	M8x50	1	140	P.508.050C
50 x 1" x 1"	22	32.5	87	53	2	M8x50	1	154	P.508.050D

508 | DOUBLE CLAMP SADDLE WITH 4 BOLTS

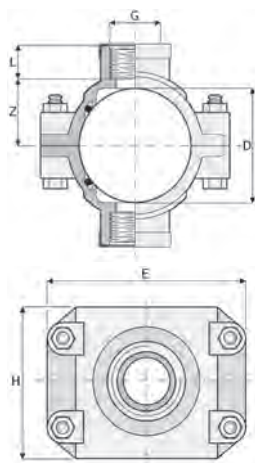

Size	L	Z	E	H	No. Bolts	Bolts	Pack	gms	Code
63 x 1/2" x 1/2"	17	40	100	71	4	M8x50	1	250	P.508.063B
63 x 3/4" x 3/4"	20	40	100	71	4	M8x50	1	252	P.508.063C
63 x 1" x 1"	22	40	100	71	4	M8x50	1	272	P.508.063D
63 x 1 1/4" x 1 1/4"	24	40	100	71	4	M8x50	1	292	P.508.063E
63 x 1 1/2" x 1 1/2"	24	40	100	71	4	M8x50	1	308	P.508.063F
75 x 1/2" x 1/2"	17	44.5	170	91	4	M8x60	1	320	P.508.075B
75 x 3/4" x 3/4"	20	44.5	170	91	4	M8x60	1	324	P.508.075C
75 x 1" x 1"	22	44.5	170	91	4	M8x60	1	340	P.508.075D
75 x 1 1/4" x 1 1/4"	24	44.5	170	91	4	M8x60	1	356	P.508.075E
75 x 1 1/2" x 1 1/2"	24	44.5	170	91	4	M8x60	1	364	P.508.075F
75 x 2" x 2"	26	44.5	170	91	4	M8x60	1	392	P.508.075G
90 x 1/2" x 1/2"	17	52	137	91	4	M8x60	1	362	P.508.090B
90 x 3/4" x 3/4"	20	52	137	91	4	M8x60	1	366	P.508.090C
90 x 1" x 1"	22	52	137	91	4	M8x60	1	374	P.508.090D
90 x 1 1/4" x 1 1/4"	24	52	137	91	4	M8x60	1	392	P.508.090E
90 x 1 1/2" x 1 1/2"	24	52	137	91	4	M8x60	1	398	P.508.090F
90 x 2" x 2"	26	52	137	91	4	M8x60	1	414	P.508.090G
110 x 1/2" x 1/2"	17	65	155	98.5	4	M8x60	1	408	P.508.110B
110 x 3/4" x 3/4"	20	65	155	98.5	4	M8x60	1	414	P.508.110C
110 x 1" x 1"	22	65	155	98.5	4	M8x60	1	422	P.508.110D
110 x 1 1/4" x 1 1/4"	24	65	155	98.5	4	M8x60	1	450	P.508.110E
110 x 1 1/2" x 1 1/2"	24	65	155	98.5	4	M8x60	1	466	P.508.110F
110 x 2" x 2"	24	65	155	98.5	4	M8x60	1	494	P.508.110G
110 x 3" x 3"	33	65	159	118.5	4	M8x60	1	730	P.508.110I
125 x 3/4" x 3/4"	20	73.5	168	101	4	M8x60	1	540	P.508.125C
125 x 1" x 1"	22	73.5	168	101	4	M8x60	1	553	P.508.125D
125 x 1 1/4" x 1 1/4"	24	73.5	168	101	4	M8x60	1	575	P.508.125E
125 x 1 1/2" x 1 1/2"	24	73.5	168	101	4	M8x60	1	589	P.508.125F
125 x 2" x 2"	24	73.5	168	101	4	M8x60	1	615	P.508.125G

> continued

MTO = Made to Order (Please refer to our Terms & Conditions).

>CLAMP SADDLES WITH STAINLESS STEEL REINFORCING RING

508 | DOUBLE CLAMP SADDLE WITH 6 BOLTS



Size	L	Z	E	H	No. Bolts	Bolts	Pack	gms	Code
140 x 1" x 1"	22	80	189	134	6	M8x75	1	968	P.508.140D
140 x 1¼" x 1¼"	24	80	189	134	6	M8x75	1	985	P.508.140E
140 x 1½" x 1½"	24	80	189	134	6	M8x75	1	995	P.508.140F
140 x 2" x 2"	24	80	189	134	6	M8x75	1	1015	P.508.140G
140 x 2½" x 2½"	24	80	189	134	6	M8x75	1	1070	P.508.140H
140 x 3" x 3"	33	80	189	134	6	M8x75	1	1200	P.508.140I
160 x 1" x 1"	22	88	213	137	6	M8x75	1	1045	P.508.160D
160 x 1¼" x 1¼"	24	88	213	137	6	M8x75	1	1080	P.508.160E
160 x 1½" x 1½"	24	88	213	137	6	M8x75	1	1098	P.508.160F
160 x 2" x 2"	28.5	88	213	135	6	M8x75	1	1135	P.508.160G
160 x 3" x 3"	36	88	213	135	6	M8x75	1	1120	P.508.160I
180 x 1¼" x 1¼"	24	115	265	171	6	M10x80	1	2356	P.508.180E
180 x 1½" x 1½"	24	115	265	171	6	M10x80	1	2380	P.508.180F
180 x 2" x 2"	24	115	265	171	6	M10x80	1	2460	P.508.180G
180 x 3" x 3"	33	115	265	171	6	M10x80	1	2660	P.508.180I
180 x 4" x 4"	42	115	265	171	6	M10x80	1	2840	P.508.180L
200 x 1¼" x 1¼"	24	115	265	171	6	M10x80	1	1910	P.508.200E
200 x 1½" x 1½"	24	115	265	171	6	M10x80	1	1935	P.508.200F
200 x 2" x 2"	24	115	265	171	6	M10x80	1	1980	P.508.200G
200 x 3" x 3"	33	115	265	171	6	M10x80	1	2200	P.508.200I
200 x 4" x 4"	42	115	265	171	6	M10x80	1	2380	P.508.200L
225 x 1¼" x 1¼"	24	127.5	280	173	6	M10x80	1	2110	P.508.225E
225 x 1½" x 1½"	24	127.5	280	173	6	M10x80	1	2130	P.508.225F
225 x 2" x 2"	24	127.5	280	173	6	M10x80	1	2195	P.508.225G
225 x 3" x 3"	33	127.5	280	173	6	M10x80	1	2420	P.508.225I
225 x 4" x 4"	42	127.5	280	173	6	M10x80	1	2600	P.508.225L
250 x 1¼" x 1¼"	24	142	313	181	6	M10x80	1	2580	P.508.250E
250 x 1½" x 1½"	24	142	313	181	6	M10x80	1	2600	P.508.250F
250 x 2" x 2"	224	142	313	181	6	M10x80	1	2650	P.508.250G
250 x 3" x 3"	33	142	313	181	6	M10x80	1	2860	P.508.250I
250 x 4" x 4"	42	142	313	181	6	M10x80	1	3040	P.508.250L
280 x 1¼" x 1¼"	24	171	385	190	6	M10x80	1	4050	P.508.280E
280 x 1½" x 1½"	24	171	385	190	6	M10x80	1	4070	P.508.280F
280 x 2" x 2"	24	171	385	190	6	M10x80	1	4120	P.508.280G
280 x 3" x 3"	33	171	385	190	6	M10x80	1	4320	P.508.280I
280 x 4" x 4"	42	171	385	190	6	M10x80	1	4500	P.508.280L
315 x 1¼" x 1¼"	24	171	385	190	6	M10x80	1	3105	P.508.315E
315 x 1½" x 1½"	24	171	385	190	6	M10x80	1	3120	P.508.315F
315 x 2" x 2"	24	171	385	190	6	M10x80	1	3170	P.508.315G
315 x 3" x 3"	33	171	385	190	6	M10x80	1	3400	P.508.315I
315 x 4" x 4"	42	171	385	190	6	M10x80	1	3600	P.508.315L

MTO = Made to Order (Please refer to our Terms & Conditions).

>CLAMP SADDLES

XXXXXXX

INSTALLATION

1) Define the position of the branch and clean the external surface of the pipe.



2) Place the O-ring into the relevant seat and position the upper part of the saddle on the pipe.



3) Couple the bottom part of the saddle with the upper one. Insert the bolts from the bottom, screw the nuts and tighten the bolts diagonally opposite each other.



4) Drill a hole in the pipe taking care not to damage the reverse of the pipe or the gasket.



COMPRESSION FITTINGS

Astore PP compression fittings are joints for PE pipes dedicated to water distribution systems.

RANGE

The extensive range of Astore fittings can satisfy a very wide range of plant engineering installation requirements.

The range comprises of fittings from D 16 mm up to D 110 mm.

The threads have a metal reinforcement on the external part of the thread for added security.

MATERIALS

Body and nut in polypropylene black co-polymer, clinching ring in white POM resin, O-ring in NBR, reinforcement ring in AISI 430.

REFERENCE STANDARDS

Astore compression fittings are manufactured in compliance with the following standards: ISO 3458, ISO 3459, ISO 3501,

ISO 3503, ISO 14236, DIN 8076-3, UNI 9561.

The joints can be installed on all PE pipes which comply with the following standards: ISO 3607, DIN 8072, DIN 8074, UNI 10910, UNI EN 12201.

The threaded versions are manufactured in compliance with standard ISO 7/1.

PRESSURE RATING AT 20°C

- 16 bar - from D 16 mm up to D 63 mm
- 10 bar - from D 75 mm up to D 110 mm

Astore is an ISO 9001 certified company, certificate No. 354.

Astore is member of the Irrigation Association (IA).

Astore compression fittings are approved by DVGW (DW-8616BQ0078).

COMPANY APPROVAL

Italian Institute of Plastics (IIP) has tested the conformity of Astore production system to UNI EN ISO 9001 (certificate No. 354).

This standard defines the characteristics (dimensional, performance, environmental, safety and organisational setup) of a product and deem them suitable for the demands of the market.

The extensive range of quality high performance products are recognised and appreciated all over the world.



ISTITUTO ITALIANO DEI PLASTICI

Certificate No. 354
UNI EN ISO 9001



D 16 – 63

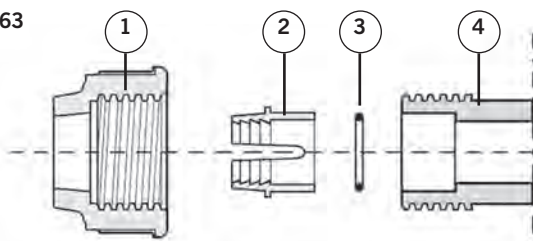

Pos.	Components
1	nut
2	clinching ring
3	O-ring
4	body

D 75 – 110

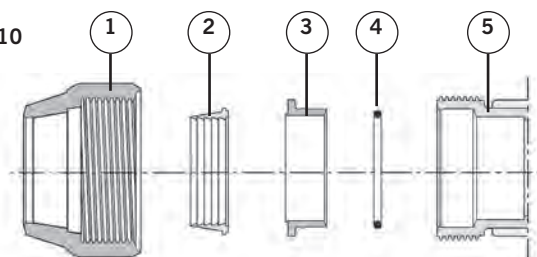

Pos.	Components
1	nut
2	clinching ring
3	thrust bushing
4	O-ring
5	body

>COMPRESSION FITTINGS

510 | COUPLING

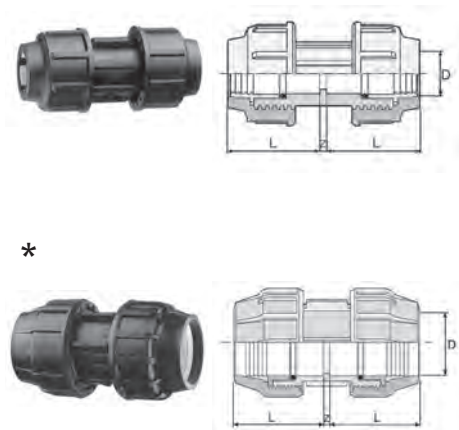

Size	L	Z	Box	gms	Code
16 x 16	45	4	360	42	R 510.0160
20 x 20	50	4	220	66	R 510.0200
25 x 25	57	4	150	96	R 510.0250
32 x 32	64	4	100	144	R 510.0320
40 x 40	76	4	50	242	R 510.0400
50 x 50	88	4	35	374	R 510.0500
63 x 63	103	9	20	599	R 510.0630
*75 x 75	118	4	35	905	R 510.0750
*90 x 90	136	5	11	1290	R 510.0900
*110 x 110	151	4	6	1970	R 510.1100

512 | REDUCER COUPLING

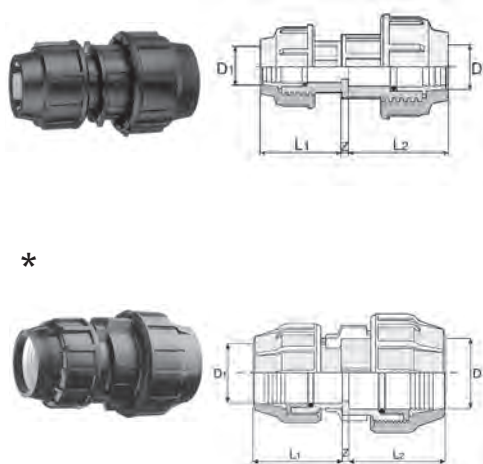

Size (DxD ₁)	L ₁	L ₂	Z	Box	gms	Code
20 x 16	40.5	50	4	260	54	P.512.020A
25 x 20	50	57	4	180	81	P.512.025B
32 x 20	50	57.5	4	110	109	P.512.032B
32 x 25	53	58	4	110	123	P.512.032C
40 x 25	57	76	4	70	183	P.512.040C
40 x 32	64	76	4	70	190	P.512.040D
50 x 25	57	88	4	40	262	P.512.050C
50 x 32	64	88	4	40	281	P.512.050D
50 x 40	76	88	4	40	319	P.512.050E
63 x 32	64	103	4	25	403	P.512.063D
63 x 40	76	103	4	25	450	P.512.063E
63 x 50	88	103	4	20	492	P.512.063F
*75 x 50	88	118	4	15	664	P.512.075F
*75 x 63	103	118	4	15	757	P.512.075G
*90 x 63	103	136	4	12	980	P.512.090G
*90 x 75	118	136	4	12	1123	P.512.090H
110 x 75	118	151	4	6	1502	P.512.110H
*110 x 90	136	151	4	6	1682	P.512.110I

MTO = All compression fittings are made to order (MTO) and sold in box quantities.

> COMPRESSION FITTINGS

511 | MALE ADAPTOR

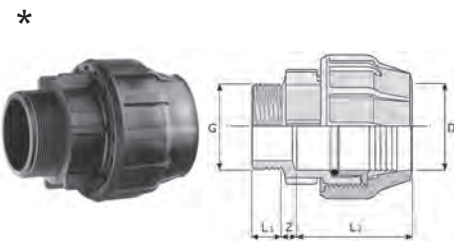
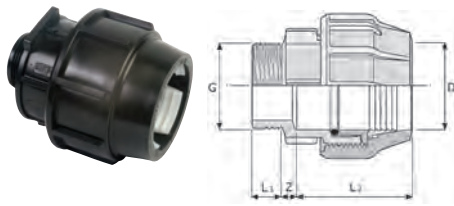

Size (DxG)	L ₁	L ₂	Z	Box	gms	Code
16 x 3/8"	18	45	16	500	23	P.511.016A
16 x 1/2"	18	45	20	500	23	P.511.016B
16 x 3/4"	20	45	20	500	25	P.511.016C
20 x 1/2"	18	50	18	400	36	P.511.020B
20 x 3/4"	20	50	19	400	38	P.511.020C
25 x 1/2"	18	57	19	250	53	P.511.025B
25 x 3/4"	20	57	20	250	54	P.511.025C
25 x 1"	20	57	26	250	56	P.511.025D
32 x 3/4"	20	64	23	150	81	P.511.032C
32 x 1"	20	64	26	150	83	P.511.032D
32 x 1 1/4"	24	64	26	150	89	P.511.032E
40 x 1"	20	76	26	90	137	P.511.040D
40 x 1 1/4"	24	76	29	90	140	P.511.040E
40 x 1 1/2"	24	76	29	90	143	P.511.040F
50 x 1 1/4"	24	88	29	55	214	P.511.050E
50 x 1 1/2"	24	88	29	55	214	P.511.050F
50 x 2"	29	88	34	55	222	P.511.050G
63 x 1 1/2"	24	103	29	30	341	P.511.063F
63 x 2"	29	103	34	30	347	P.511.063G
63 x 2 1/2"	32	103	39	30	361	P.511.063H
*75 x 2"	29	118	34	25	520	P.511.075G
*75 x 2 1/2"	32	118	40	25	516	P.511.075H
*75 x 3"	38	118	43	25	534	P.511.075I
*90 x 2"	29	136	34	16	740	P.511.090G
*90 x 2 1/2"	32	136	40	16	750	P.511.090H
*90 x 3"	38	136	43	16	750	P.511.090I
*90 x 4"	44	136	49	16	793	P.511.090L
*110 x 2"	27	150	34	8	1040	P.511.110G
*110 x 3"	38	151	43	8	1138	P.511.110I
*110 x 4"	44	151	49	8	1156	P.511.110L

MTO = All compression fittings are made to order (MTO) and sold in box quantities.

>COMPRESSION FITTINGS

601 | FEMALE ADAPTOR

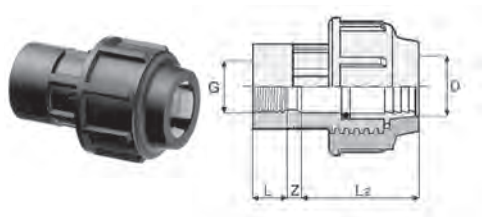

*

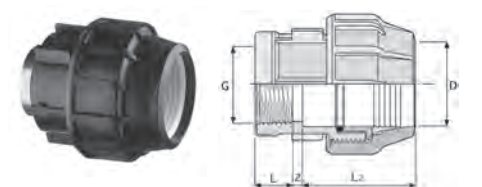

Size (DxG)	L ₁	L ₂	Z	Box	gms	Code
16 x 3/8"	19	45	4	500	26	P.601.016A
16 x 1/2"	19	45	4	500	30	P.601.016B
20 x 1/2"	19	50	5	400	41	P.601.020B
20 x 3/4"	21	50	6	340	47	P.601.020C
25 x 1/2"	19	57	3	250	54	P.601.025B
25 x 3/4"	21	57	6	250	61	P.601.025C
25 x 1"	21	57	8	200	68	P.601.025D
32 x 1/2"	19	64	4	150	85	P.601.032B
32 x 3/4"	21	64	4	150	88	P.601.032C
32 x 1"	21	64	7	150	95	P.601.032D
32 x 1 1/4"	25	64	8	130	100	P.601.032E
40 x 1"	21	76	4	90	148	P.601.040D
40 x 1 1/4"	25	76	4	90	155	P.601.040E
40 x 1 1/2"	25	76	6	90	172	P.601.040F
50 x 1 1/4"	25	88	4	55	231	P.601.050E
50 x 1 1/2"	25	88	6	55	234	P.601.050F
50 x 2"	30	88	6	55	254	P.601.050G
63 x 1 1/2"	25	103	9	30	360	P.601.063F
63 x 2"	30	103	3	30	374	P.601.063G
*75 x 2"	30	118	7	25	537	P.601.075G
*75 x 2 1/2"	33	118	4	25	635	P.601.075H
*75 x 3"	39	118	6	25	580	P.601.075I
*90 x 2"	30	136	3	16	700	P.601.090G
*90 x 2 1/2"	33	136	10	16	730	P.601.090H
*90 x 3"	39	136	10	16	932	P.601.090I
110 x 3"	39	151	10	8	1316	P.601.110I
*110 x 4"	45	151	10	8	1390	P.601.110L

521 | PLUG



*

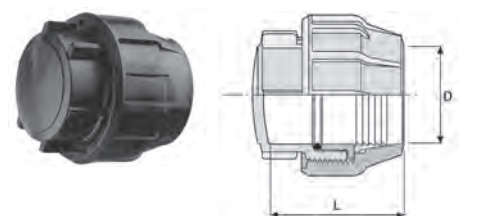

Size	L	Box	gms	Code
16	45	500	30	P.521.0160
20	50	400	50	P.521.0200
25	57	250	65	P.521.0250
32	64	150	100	P.521.0320
40	76	90	165	P.521.0400
50	88	60	245	P.521.0500
63	103	30	390	P.521.0630
*75	118	28	655	P.521.0750
*90	136	22	950	P.521.0900
*110	151	8	1420	P.521.1100

MTO = All compression fittings are made to order (MTO) and sold in box quantities.

>COMPRESSION FITTINGS

513 | ELBOW

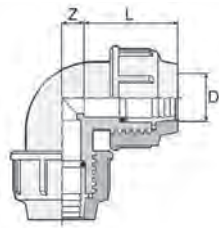

*

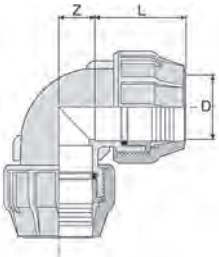

Size	L	Z	Box	gms	Code
16 x 16	45	11	360	45	P.513.0160
20 x 20	50	13	200	70	P.513.0200
25 x 25	57	15	150	105	P.513.0250
32 x 32	64	19	80	161	P.513.0320
40 x 40	76	23	50	269	P.513.0400
50 x 50	88	28	30	415	P.513.0500
*75 x 75	103	35	15	656	P.513.0630
*90 x 90	118	41	11	994	P.513.0750
*110 x 110	136	49	8	1450	P.513.0900
	151	60	4	2193	P.513.1100

519 | ELBOW MALE THREADED

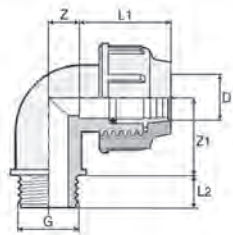

*

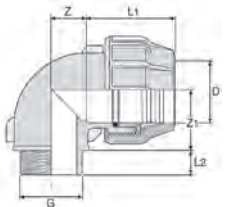

Size (DxG)	L ₁	L ₂	Z ₁	Z ₂	Box	gms	Code
16 x 1/2"	45	18	11	40	400	29	P.519.016B
20 x 1/2"	50	18	13	46	260	50	P.519.020B
20 x 3/4"	50	20	13	46	260	50	P.519.020C
25 x 1/2"	57	20	15	52	180	75	P.519.025B
25 x 3/4"	57	20	15	52	180	75	P.519.025C
25 x 1"	57	20	15	52	180	75	P.519.025D
32 x 1"	64	20	19	61	110	120	P.519.032D
32 x 1 1/4"	64	24	19	61	110	120	P.519.032E
40 x 1 1/4"	76	24	23	69	60	198	P.519.040E
40 x 1 1/2"	76	24	23	69	60	198	P.519.040F
50 x 1 1/2"	88	24	28	82	35	305	P.519.050F
50 x 2"	88	29	28	82	35	305	P.519.050G
63 x 2"	103	29	35	96	20	480	P.519.063G
63 x 2 1/2"	103	32	35	96	20	480	P.519.063H
*75 x 2 1/2"	118	32	41	111	14	709	P.519.075H
*75 x 3"	118	38	41	111	14	709	P.519.075I
*90 x 3"	136	38	49	128	10	1031	P.519.090I
90 x 4"	136	38	49	128	10	1031	P.519.090L
*110 x 4"	153	44	58	143	5	1549	P.519.110L

MTO = All compression fittings are made to order (MTO) and sold in box quantities.

>COMPRESSION FITTINGS

518 | ELBOW FEMALE THREADED

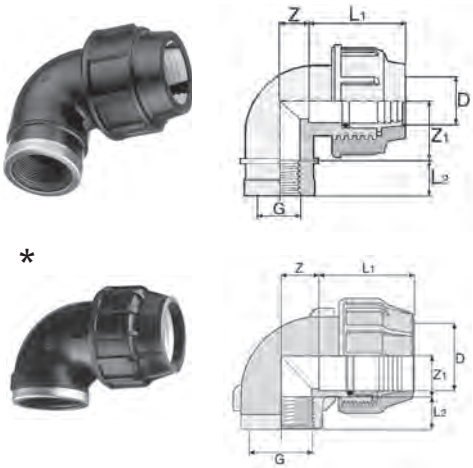

Size (DxG)	L ₁	L ₂	Z ₁	Z ₂	Box	gms	Code
16 x 3/8"	45	19	11	25	400	32	P.518.016A
16 x 1/2"	45	19	11	28	400	32	P.518.016B
20 x 1/2"	50	19	13	28	260	51	P.518.020B
20 x 3/4"	57	20	13	28	260	51	P.518.020C
25 x 1/2"	57	19	13	28	180	75	P.518.025B
25 x 3/4"	57	21	15	31	180	77	P.518.025C
25 x 1"	57	21	15	31	160	77	P.518.025D
32 x 1/2"	64	19	19	40	110	122	P.518.032B
32 x 3/4"	64	21	19	40	110	122	P.518.032C
32 x 1"	64	21	19	40	110	122	P.518.032D
32 x 1 1/4"	64	25	19	40	90	122	P.518.032E
40 x 1 1/4"	76	25	23	44	60	198	P.518.040E
40 x 1 1/2"	76	25	23	51	60	198	P.518.040F
50 x 1 1/2"	88	25	28	55	35	316	P.518.050F
50 x 2"	88	30	28	55	35	316	P.518.050G
63 x 2"	103	30	35	63	20	582	P.518.063G
63 x 2 1/2"	103	33	35	78	20	499	P.518.063H
*75 x 2 1/2"	118	33	41	73	14	810	P.518.075H
*75 x 3"	118	39	41	73	14	810	P.518.075I
*90 x 3"	136	39	49	87	10	1213	P.518.090I
90 x 4"	136	45	49	87	10	1213	P.518.090L
*110 x 4"	151	45	60	103	5	1767	P.518.110L

514 | TEE 521

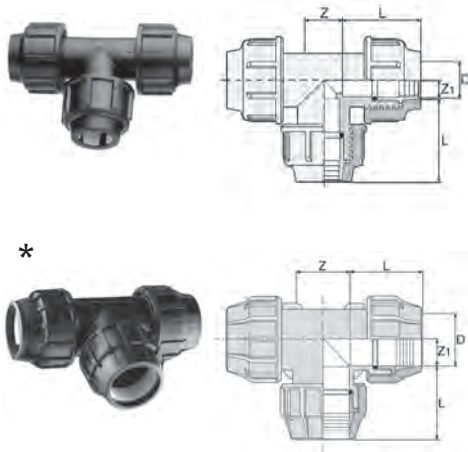

Size	L	Z	Z ₁	Box	gms	Code
16 x 16 x 16	45	22	11	220	66	P.514.0160
20 x 20 x 20	50	26	13	120	101	P.514.0200
20 x 25 x 20	53	26	13	120	115	P.514.020C
25 x 25 x 25	57	30	15	90	151	P.514.0250
25 x 32 x 25	54	30	15	70	190	P.514.025D
32 x 32 x 32	64	38	19	50	236	P.514.0320
40 x 40 x 40	76	46	23	30	390	P.514.0400
50 x 50 x 50	88	56	28	20	598	P.514.0500
63 x 63 x 63	103	70	35	12	944	P.514.0630
*75 x 75 x 75	118	82	41	7	1427	P.514.0750
*90 x 90 x 90	136	98	49	5	2113	P.514.0900
*110 x 110 x 110	151	120	60	3	3191	P.514.1100

MTO = All compression fittings are made to order (MTO) and sold in box quantities.

>COMPRESSION FITTINGS

516 | TEE MALE THREADED

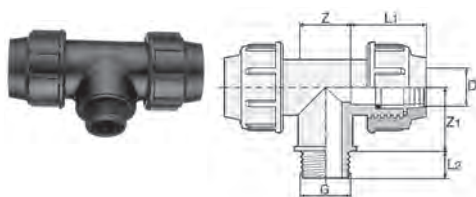

*

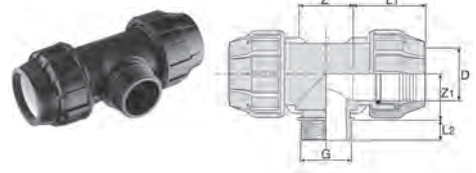

Size (DxGxD)	L ₁	L ₂	Z	Z ₁	Box	gms	Code
16 x 1/2" x 16	45	18	22	40	240	52	P.516.016B
20 x 1/2" x 20	50	18	26	46	140	82	P.516.020B
20 x 3/4" x 20	50	20	26	46	140	82	P.516.020C
25 x 3/4" x 25	57	20	30	52	100	122	P.516.025C
25 x 1" x 25	57	20	30	52	100	122	P.516.025D
32 x 1" x 32	64	20	38	61	60	190	P.516.032D
32 x 1 1/4" x 32	64	24	38	61	60	190	P.516.032E
40 x 1 1/4" x 40	76	24	46	69	30	322	P.516.040E
40 x 1 1/2" x 40	76	24	46	69	30	322	P.516.040F
50 x 1 1/2" x 50	88	24	56	82	20	490	P.516.050F
50 x 2" x 50	88	29	56	82	20	490	P.516.050G
63 x 2" x 63	103	29	70	96	12	775	P.516.063G
63 x 2 1/2" x 63	103	32	70	96	12	775	P.516.063H
*75 x 2 1/2" x 75	118	32	82	111	10	790	P.516.075H
75 x 3" x 75	118	38	82	111	10	1150	P.516.075I
*90 x 3" x 90	125	38	97	122	6	1800	P.516.090I
90 x 4" x 90	125	44	97	130	6	1680	P.516.090L
*110 x 4" x 110	144	44	119	143	3	2523	P.516.110L

515 | TEE FEMALE THREADED

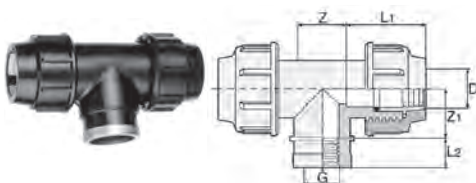

*

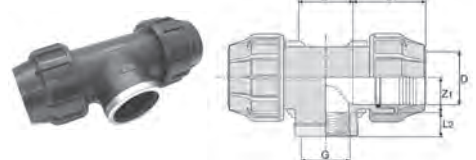

Size (DxGxD)	L ₁	L ₂	Z	Z ₁	Box	gms	Code
16 x 3/8" x 16	45	19	22	25	240	55	P.515.016A
16 x 1/2" x 16	45	19	22	19	240	48	P.515.016B
20 x 1/2" x 20	50	19	26	27	140	85	P.515.020B
20 x 3/4" x 20	50	19	26	27	140	85	P.515.020C
25 x 1/2" x 25	57	19	30	31	100	127	P.515.025B
25 x 3/4" x 25	57	21	30	31	100	127	P.515.025C
25 x 1" x 25	57	21	30	35	100	127	P.515.025D
32 x 1 1/2" x 32	64	19	38	40	60	195	P.515.032B
32 x 3/4" x 32	64	21	38	40	60	195	P.515.032C
32 x 1" x 32	64	21	38	40	60	195	P.515.032D
32 x 1 1/4" x 32	64	25	38	40	50	195	P.515.032E
40 x 1" x 40	76	21	46	44	30	322	P.515.040D
40 x 1 1/4" x 40	76	25	46	44	30	322	P.515.040E
40 x 1 1/2" x 40	76	25	46	50	30	322	P.515.040F
50 x 1 1/2" x 50	88	25	56	55	20	510	P.515.050F
50 x 2" x 50	88	25	56	55	20	510	P.515.050G
63 x 2" x 63	103	30	70	64	12	801	P.515.063G
63 x 2 1/2" x 63	103	33	70	64	12	801	P.515.063H
*75 x 2 1/2" x 75	118	33	82	75	10	1270	P.515.075H
75 x 3" x 75	118	36	82	80	10	1270	P.515.075I
*90 x 3" x 90	136	36	98	87	6	1882	P.515.090I
90 x 4" x 90	136	40	98	91	6	1882	P.515.090L
*110 x 4" x 110	151	40	120	103	B	2780	P.515.110L

MTO = All compression fittings are made to order (MTO) and sold in box quantities.

> COMPRESSION FITTINGS

523 | REDUCING TEE

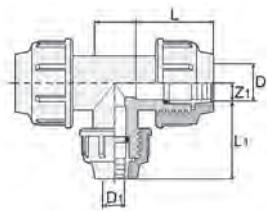

Size (DxD ₁ xD)	L	L ₁	Z	Z ₁	Box	gms	Code
25 x 20 x 25	51.5	47	30	14	100	132	P.523.025B
32 x 25 x 32	57.5	51	32	19	60	207	P.523.032C
40 x 32 x 40	83	75	40	17	40	340	P.523.040D
50 x 40 x 50	100	90	44	23	20	580	P.523.050E
63 x 50 x 63	95	85	66	33	12	950	P.523.063F

520 | FLANGE ADAPTOR

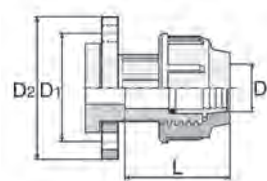

Size	L	D ₁	D ₂	No. Drill	Pack	Box	gms	Code
*75 x 2½"	118	145	185	4	1	5	886	P.520.075H
75 x 3"	118	160	200	8	1	13	992	P.520.075I
*90 x 3"	136	160	200	4	1	8	1198	P.520.090I
90 x 4"	136	180	220	8	1	8	1364	P.520.090L
*110 x 4"	151	180	220	8	1	6	1684	P.520.110L

*

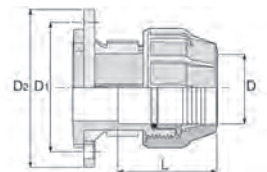

MTO = All compression fittings are made to order (MTO) and sold in box quantities.

> COMPRESSION FITTINGS

524 | WALL BRACKETS

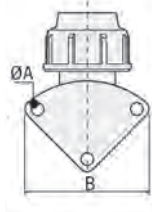
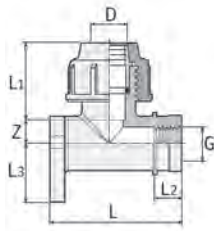

Size (DxG)	L	L ₁	L ₂	Z	A	B	Box	gms	Code
25 x 3/4"	83.5	57	21	14	6	62	150	76	P.524.025C

517 | REDUCER JOINT

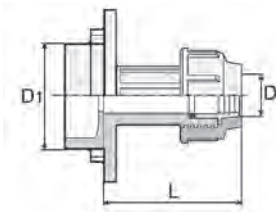

Size (D ₁ xD)	L	Box	gms	Code
50 x 20	79	120	55	P.517.050B
50 x 25	81	120	65	P.517.050C

MTO = All compression fittings are made to order (MTO) and sold in box quantities.

>COMPRESSION FITTINGS

INSTALLATION D16-63

1) Cut the pipe square at 90° to the required length using a pipe cutter.

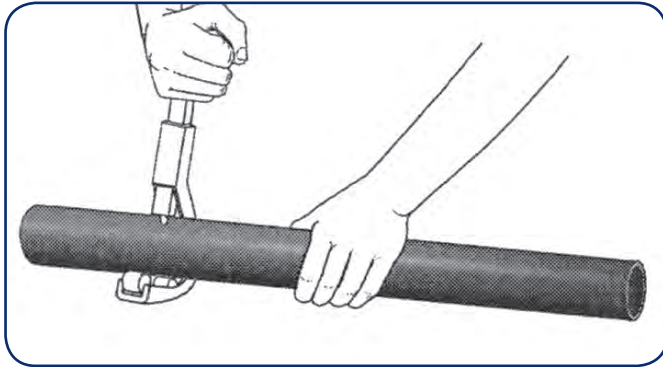

2) Insert on to the pipe in the following order, collar first and place the O-ring on the mouth of the pipe (fig.2 & 3).

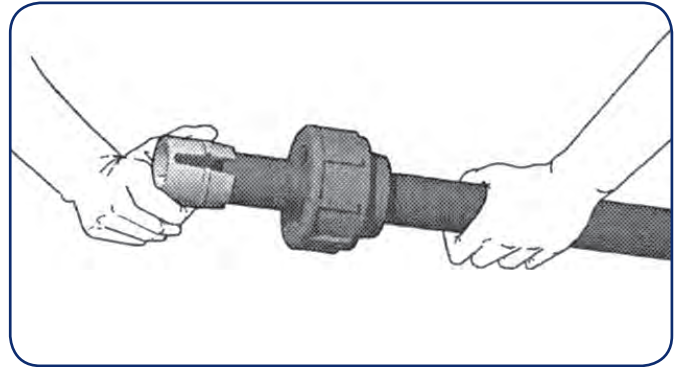

3) Insert the body of the joint until the gasket is located into the body of the fitting (fig.4).

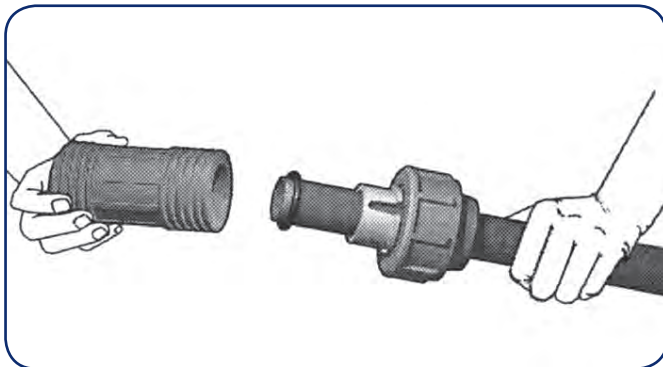

4) Insert the body of the joint until the gasket has slid inside the body.

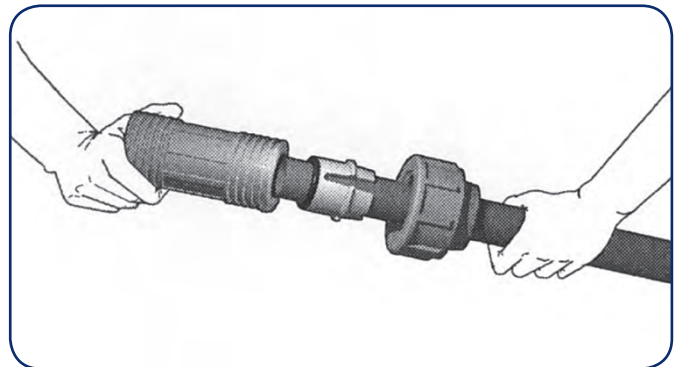

5) Fully tighten the nut. The nut can be tightened manually up to d32 mm, but for larger diameters it is advisable to use a pipe wrench.

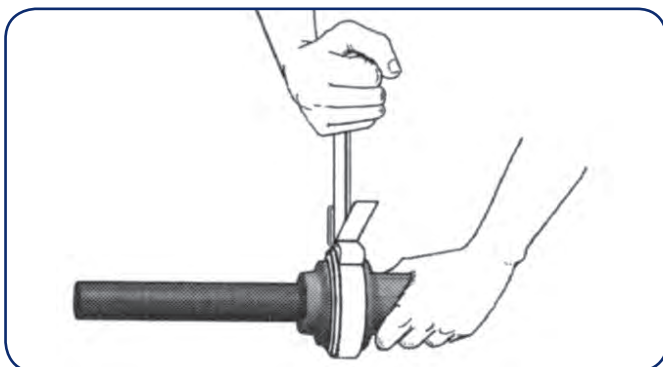

> COMPRESSION FITTINGS

INSTALLATION D75-90

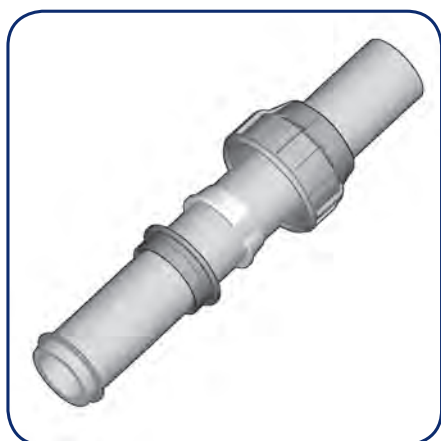

1) Cut the pipe clean and square at 90° to the required length using a pipe cutter. Lubricate the pipe and the gasket so that the fittings sit correctly on the pipe. Insert the fittings onto the pipe in the following order: ring nut, clinching ring, thrust bushing and put the gasket on the mouth of the pipe.

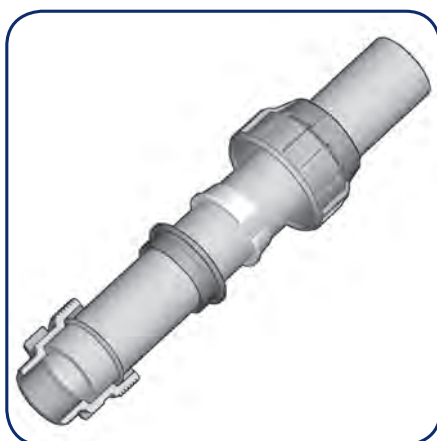

2) Push the body of the fitting on the pipe until the gasket is pushed inside the body (fig.2).

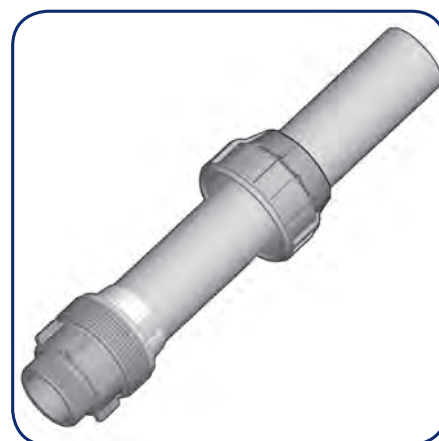

3) Push the body of the fitting on the pipe until the gasket is located in the body itself (fig.2).

INSTALLATION D110

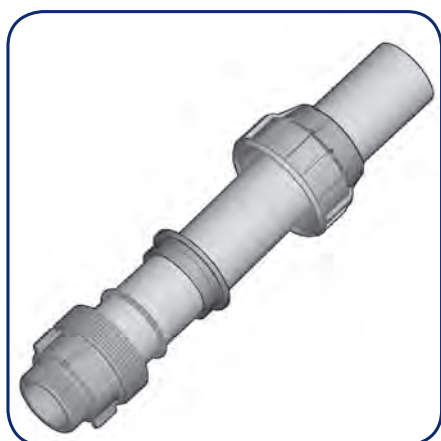

1) Cut the pipe clean and square at 90° to the required length using a pipe cutter. Lubricate the pipe and the gasket so that the fittings sit correctly on the pipe. Insert the fittings onto the pipe in the following order: ring nut, thrust bushing, gasket and body of the fitting.

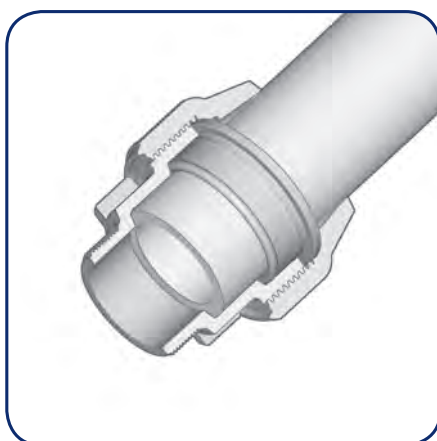

2) Fully tighten the nut until the gasket is stuck inside the body.

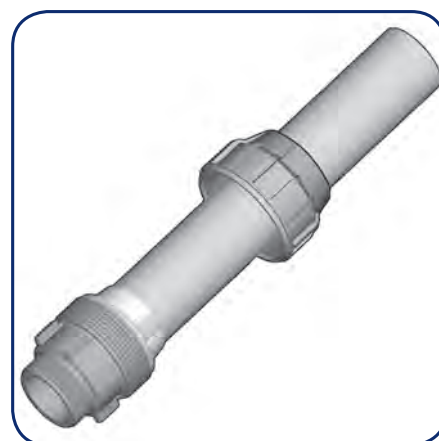

3) Untighten the nut, open the clinching ring and insert it on the pipe, fully tighten the nut using a pipe wrench.

ASTORE UK - TERMS AND CONDITIONS OF SALE

1. **DEFINITIONS:**

'Seller' shall mean Glynwed Pipe Systems Limited, registered in England under number 1698059. 'Buyer' shall mean any company, organisation or individual to whom a quotation is offered, or whose order is accepted by the Seller.
2. **CONDITIONS:**

All offers, quotations, estimates, acceptances and contracts are subject to these Conditions of Business and any terms or conditions which any other person shall seek to impose or make part of any contract shall, so far as is inconsistent with these Conditions of Business, not apply unless expressly agreed by the Buyer in writing. The headings in these conditions are for convenience only and shall not affect their interpretation.
3. **QUOTATIONS, PRICE VARIATIONS AND MADE TO ORDER GOODS:**
 - a) Any quotation given by the Seller is an invitation to the Buyer to make an offer only and no order of the Buyer placed with the Seller in pursuance of a quotation or otherwise shall be binding on the Seller unless and until it is accepted in writing by the Seller.
 - b) Unless stated otherwise, all quotations and published price lists are ex works, exclusive of VAT and shall remain valid for 30 days or such period as may be quoted but nevertheless the Seller may amend or withdraw any quotation by written or oral notice. Quotations may be varied if the Buyer makes variations in his specifications but see special conditions relating to Made to Order Goods.
 - c) Certain products are denoted 'MTO' in the Seller's published price lists. These products are Made to Order Goods and the Seller manufactures or procures these goods on a bespoke basis only. Where a Buyer has made an offer for "MTO" products that the Seller has accepted in writing the Buyer forfeits their right to cancel their offer unless the Seller confirms in writing that it will accept cancellation by the Buyer. Where the Seller does not provide written confirmation of the Buyer's cancellation the Buyer remains liable for the full contractual value of all 'MTO' products. 'MTO' 'Call-off' orders must be taken within 12 months of the original order date.
4. **STATEMENTS OR REPRESENTATIONS TO THE BUYER:**

If any statement or representation has been made to the Buyer upon which the Buyer relies other than in the documents enclosed with the Seller's quotation, the Buyer must set out that statement or representation in a document to be attached to or endorsed on the order in which case the Seller may submit a new quotation.
5. **DELIVERY - TIME:**
 - a) Any period for delivery given at any time and in any manner by the Seller is an estimate only and is not binding on the Seller. Delivery periods are normally calculated from the later of:
 - i) acceptance of order; or
 - ii) where applicable, the receipt by the Seller of a detailed specification or drawings.
 - b) Time shall not be deemed to be of the essence of the contract. Failure by the Seller to meet any quoted delivery period for any part or the whole of the order shall not entitle the Buyer to rescind the contract or to claim damages of any nature.
 - c) The Seller will endeavour to comply with reasonable requests by the Buyer for postponement of delivery but shall be under no obligation to do so. Where delivery is postponed otherwise than due to default by the Seller the Buyer shall pay all costs and expenses including a reasonable charge for storage and transportation occasioned thereby and an extra charge for split delivery if applicable.
 - d) The Buyer will receive delivery of any consignment between the hours of 8.00am and 4.00pm Monday to Friday inclusive, unless otherwise agreed in writing. Cost incurred by the Seller arising from the Buyer's refusal to accept consignments within the agreed hours shall be borne by the Buyer.
6. **DELIVERY AND RISK:**
 - a) Except where stated to the contrary in the contract, delivery shall be made as follows:
 - i) where the Buyer provides the transport, delivery shall be made ex the Seller's works;
 - ii) where the Seller provides the transport, delivery shall be made to the premises of the Buyer, or the premises of the Buyer's customer or works site if the Buyer has requested delivery to be so made but where the Buyer has made such a request the Seller will make a first delivery to the Buyer's customer or works site as so much of the goods as is available for that delivery but subsequent deliveries will be made to the premises of the Buyer.
 - b) The Seller may at its discretion make partial delivery of orders and invoice the same.
 - c) Risk in the goods shall pass on delivery.
 - d) Where goods are sent FOB the Seller's responsibility shall cease when the goods are placed on board ship or aircraft without the need for the Seller to give notice to the Buyer and the provisions of Section 32(3) of the Sale of Goods Act 1979 shall not apply.
7. **OWNERSHIP OF GOODS:**
 - a) The goods shall remain the sole and absolute property of the Seller as legal and equitable owner until such time as the Buyer shall have paid to the Seller the contract price together with the full price of any other goods the subject of any contract between the Seller and the Buyer.
 - b) The Buyer acknowledges that until such time as the property in the goods passes to the Buyer he is in possession of the goods as a bailee and fiduciary agent for the Seller and the Purchaser shall store the goods in such a manner that they are clearly identifiable as the property of the Seller.
 - c) Until payment due under all contracts between the Buyer and the Seller had been made in full, in the event of sale of the goods by the Buyer:
 - i) the Seller shall be entitled to trace all proceeds of sale received by the Buyer through any bank or other account maintained by the Buyer; and
 - ii) the Buyer shall if requested by the Seller in writing to so assign its rights to recover the selling price of the goods from the third parties concerned. Such monies to be held separately by the Buyer as agent on behalf of the Seller.
 - d) The Seller may for the purpose of recovery of its goods enter upon any premises where they are stored or where they are reasonably thought to be stored and may repossess the same.
8. **TERMS OF PAYMENT:**

In the event of default in payment according to the agreed payment terms between the Seller and the Buyer – i.e. by the end of the month following the month of despatch of the goods the Seller shall be entitled without prejudice to any other right or remedy to suspend all further deliveries and to charge interest on any amount outstanding at the rate of 2% per month until payment in full is made (a part of a month being treated as a full month for the purpose of calculating interest).
9. **SHORTAGES AND DEFECTS APPARENT ON DELIVERY:**
 - a) It shall be the responsibility of the Buyer to inspect or arrange for an inspection of the goods on delivery whether the goods are delivered to the Buyer's premises or to the premises of the Buyer's customer or to a works site. If no such inspection is made the Buyer shall be deemed to have accepted the goods.
 - b) The Buyer shall have no claim for shortages or defects apparent on inspection unless:
 - i) a written complaint is made to the Seller within three days of receipt of the goods specifying the shortage or defect; and
 - ii) the Seller is within seven days of receipt of the complaint given an opportunity to inspect the goods and investigate the complaint before any use is made of the goods.
 - c) If a complaint is not made to the Seller as herein provided then in respect of such shortages or defects the goods shall be deemed to be in all respects in accordance with the contract and the Buyer shall be bound to pay for the same accordingly.
10. **CLAIMS FOR DEFECTS NOT APPARENT ON INSPECTION:**
 - a) The Buyer shall have no claim for defects not apparent on inspection unless the Seller is notified of defective workmanship or materials within twelve months from delivery of the goods. Provided that the goods have been installed and applied in accordance with any relevant recommendations made by the Seller, the Seller will at its option replace the goods or refund the net invoiced price in respect of the goods which have been shown to be defective. If the Seller does so supply substitute goods the Buyer shall be bound to accept such substituted goods in full satisfaction of the obligations of the Seller under the contract.
 - b) The Buyer shall in any event have no claim or set-off in respect of defects unless a written complaint is sent to the Seller as soon as the defect is noticed and no use is made of the goods thereafter or alteration made thereto by the Buyer before the Seller is given an opportunity to inspect the goods.
 - c) The Buyer is responsible for ensuring that the goods are fit for any particular purpose, and no warranty or condition of fitness for any particular purpose is to be implied into the contract.
11. **LIABILITY:**

Save as stated in Conditions 9 and 10 (and save in respect of death or personal injury resulting from the negligence of the Seller its servants or agents) the Seller shall not be liable for any claim or claims for direct or indirect consequential or incidental injury loss or damage made by the Buyer against the Seller whether in contract or in tort (including negligence on the part of the Seller its servants or agents) arising out of or in connection with any defect in the goods or their fitness or otherwise for any particular purpose or any act omission neglect or default of the Seller its servants or agents in the performance of the contract.
12. **FORCE MAJEURE:**

Notwithstanding anything herein contained neither the Buyer nor the Seller is to be held liable for any delay or failure to carry out the contract due wholly or in part to an act of God action by any Government whether British or foreign civil war strikes and/or lockouts wheresoever occurring fire trade disputes floods or unfavourable weather or any material becoming unavailable or irreplaceable (whether at all or at commercially acceptable prices) or any other circumstances beyond the control of the Seller.
13. **SUB-CONTRACTING:**

The Seller reserves the right to sub-contract the fulfilment of any order or any part thereof.
14. **INSOLVENCY AND BREACH OF CONTRACT:**

In the event that:

 - a) the Buyer commits any breach of the contract and fails to remedy such breach (if capable of remedy) within a period of thirty days from receipt of a notice in writing from the Seller requesting such remedy; or
 - b) any distress or execution is levied upon any of the goods or property of the Buyer; or
 - c) the Buyer offers to make any arrangements with or for the benefit of its creditors or (if an individual) becomes subject to a petition for a bankruptcy order or (being a limited company) has a receiver appointed of the whole or any part of its undertaking property or assets; or
 - d) an order is made or a resolution is passed or analogous proceedings are taken for the winding up of the Buyer (save for the purpose of reconstruction or amalgamation with insolvency and previously approved in writing by the Seller) the Seller shall thereupon be entitled without prejudice to its other rights hereunder forthwith to suspend all further deliveries until the default has been made good or to determine the contract and any unfulfilled part thereof or at the Seller's option to make partial deliveries. Notwithstanding any such termination the Buyer shall pay to the Seller at the contract rate for all the goods delivered up to and including the date of termination.
15. **INDUSTRIAL PROPERTY RIGHTS:**

If goods supplied by the Seller to the Buyer's design or specifications infringe or are alleged to infringe any patent or registered design right or copyright the Buyer will indemnify the Seller against all damages, costs and expenses incurred by the Seller as a result of the infringement or allegation. The Buyer will give the Seller all possible help in meeting any infringement claim brought against the Seller.
16. **BUYER'S ERROR IN ORDERING:**

In the event the Buyer orders incorrectly the Seller will be under no obligation to the Buyer to rectify or assist in rectifying the error.
17. **LAW AND JURISDICTION:**

The contract shall be subject in all respects to English Law and to the jurisdiction of the English Courts.

Astore UK reserves the right to modify the details in this publication as products and specifications are updated and improved.

The content of this publication is for general information only and it is user's responsibility to determine the suitability of any product for the purpose intended.

For further information on all Astore UK products and services contact our Customer Services Team as detailed below.

Customer Services
Tel: 0844 800 5509
Fax: 01543 471682

Astore UK is a trade name of Glynwed Pipe Systems Ltd. Company Number 1698059

Registered Office:

Astore UK
Hyssop Close
Swaffield Park
Cannock
Staffordshire
WS11 7FU
United Kingdom



ASTORE UK

Hyssop Close, Swaffield Park, Cannock, Staffs WS11 7FU
Telephone: 0844 800 5509 • Fax: +44 (0)1543 471682
E-mail: sales@astore.uk.com
Website: www.astore.co.uk