

DUAL

CONNECT AND GO

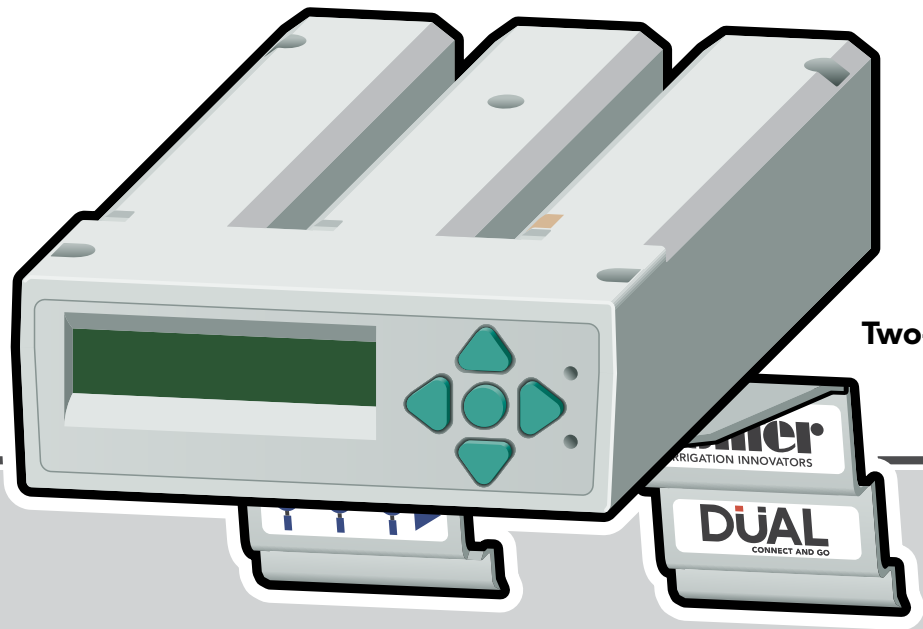

DUAL™ 48M
Two-Wire/Decoder Module

NEW

Owner's Manual and Programming Instructions
For use with I-CORE controller

Hunter®

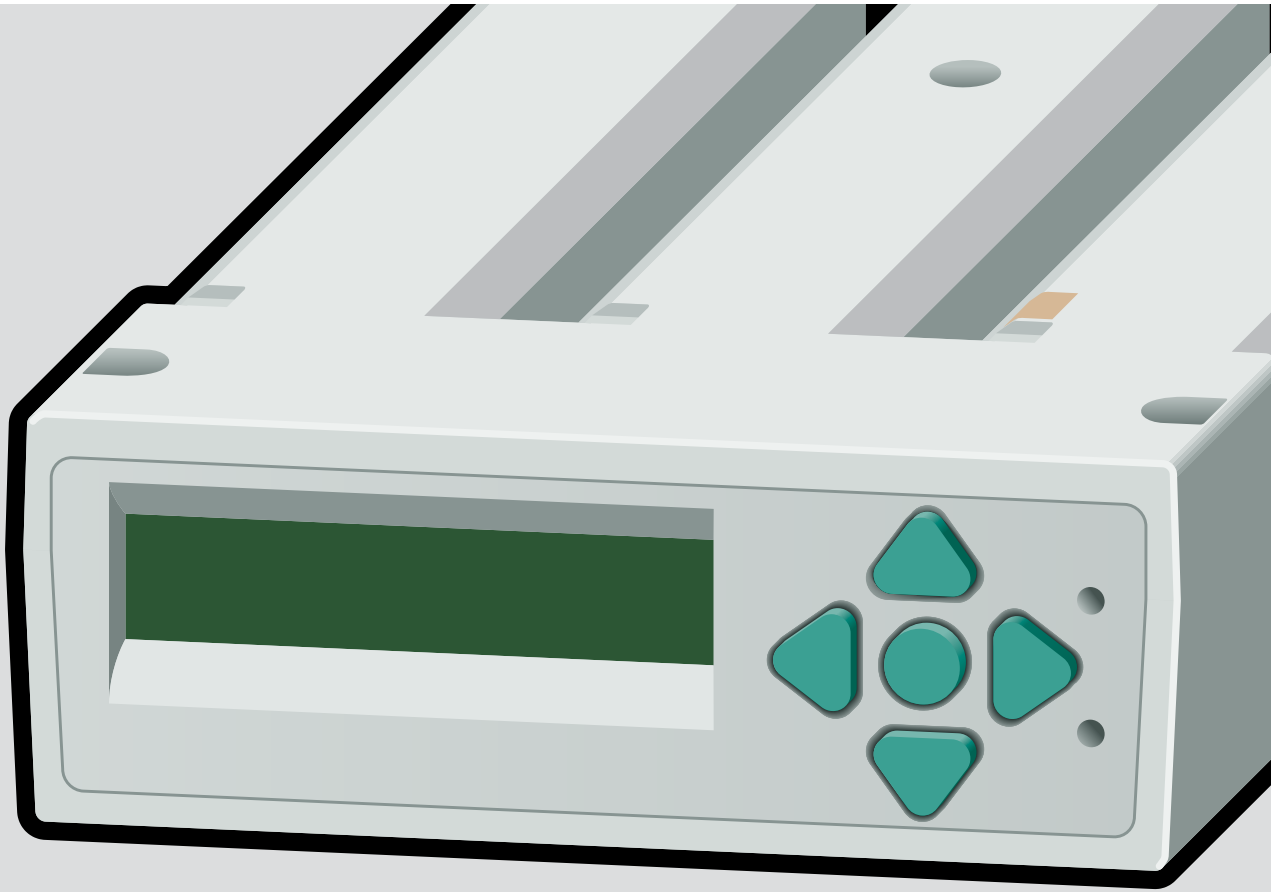

For use with
I-CORE

TABLE OF CONTENTS

SYSTEM COMPONENTS	4
OVERVIEW OF DUAL™ DECODER OPERATION	5
Decoder Benefits	5
SYSTEM OVERVIEW	6
INSTALLATION OF DUAL DECODER MODULE	7
Installation for Combined Decoder and ICM-600 Module.....	7
WIRE SPECIFICATIONS AND INSTALLATION	8
Using Pre-Existing Wire	8
TYPICAL WIRE LAYOUT	9
WIRE SPECIFICATION AND INSTALLATION	11
Connecting the Two-Wire Paths	11
OVERVIEW OF DECODER PROGRAMMING	12
Programing Decoder Stations	12
INSTALLING THE DECODERS	15
LIGHTNING PROTECTION AND GROUNDING	17
DUAL-S Installation.....	17
In-Line Surge Arrestor Installation	18
End of Line Surge Arrestor Installation.....	18
DIAGNOSTICS	20
Read Current Function	20
Find Solenoid Function	20
Operating Stations	20
TROUBLESHOOTING	21
Important tools.....	21
ICD-HP Handheld Wireless Programmer	21
Faults and Fault Messages	21

SYSTEM COMPONENTS

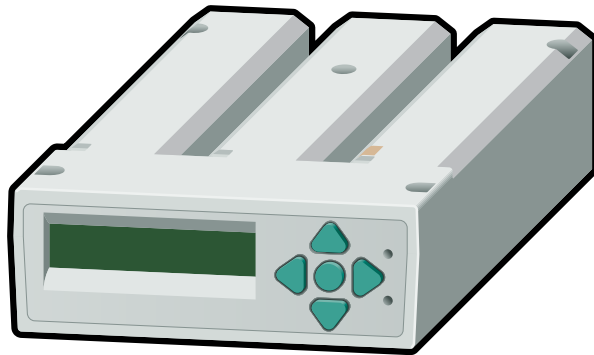

DUAL 48M



DUAL 1

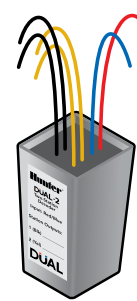

DUAL 2

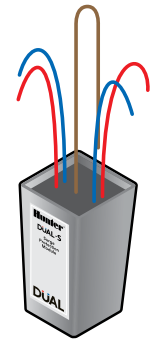

DUAL 5

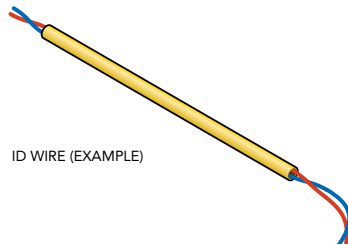

ID WIRE (EXAMPLE)

OVERVIEW OF DUAL™ DECODER OPERATION

DUAL™ two-wire decoder technology permits control of irrigation systems over relatively long distances by attaching waterproof decoders as needed in a low voltage, direct burial two-wire path. The wire is cut wherever station control is needed, and the decoder wires are spliced into the path. The decoders are then connected to local standard 24 VAC solenoids for individual operation of valves and similar devices. Each decoder is uniquely addressed, and both the signal for their address and the power required for solenoid operation are sent over the single pair of wires. Up to 48 decoders can be individually operated by the I-CORE controller over a single pair of wires in this manner.

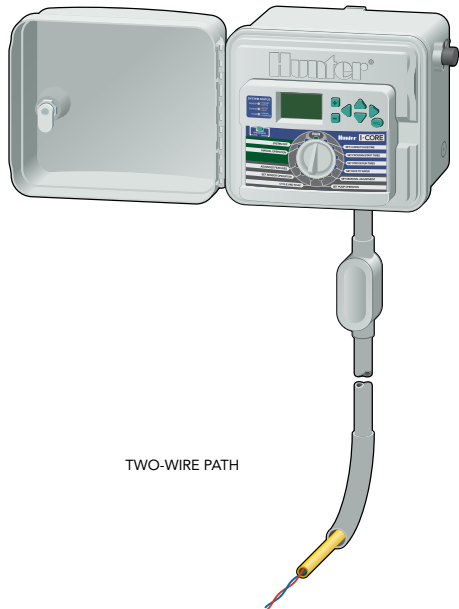

Decoder Benefits

Decoder systems save wire. A significant benefit is the ability to operate up to 48 stations with only two wires, instead of approximately 50 wires for conventional installations. This can also save labor associated with large numbers of individual wire runs.

Decoder systems are flexible. As long as the two-wire path is accessible throughout an irrigation system, stations can be added later by inserting additional decoders into the path at any point, with minimum disruption of turf and landscape. Decoder wire runs can even be spliced and tee'd to follow pipe trenches, minimizing wasted wire.

Decoder systems are lightning resistant. While no irrigation system is immune to lightning, decoder systems have less wire in the ground and, when properly installed, have excellent grounding and surge suppression. They are popular in regions with high lightning exposure.

Decoder systems are relatively easy to program and troubleshoot. There are only two wires per path and a single DUAL-M output module for the decoder functions, equipped with diagnostics. The controller operating system is the same as a conventional I-CORE, which makes programming easy for those already familiar with the I-CORE controller.

SYSTEM OVERVIEW

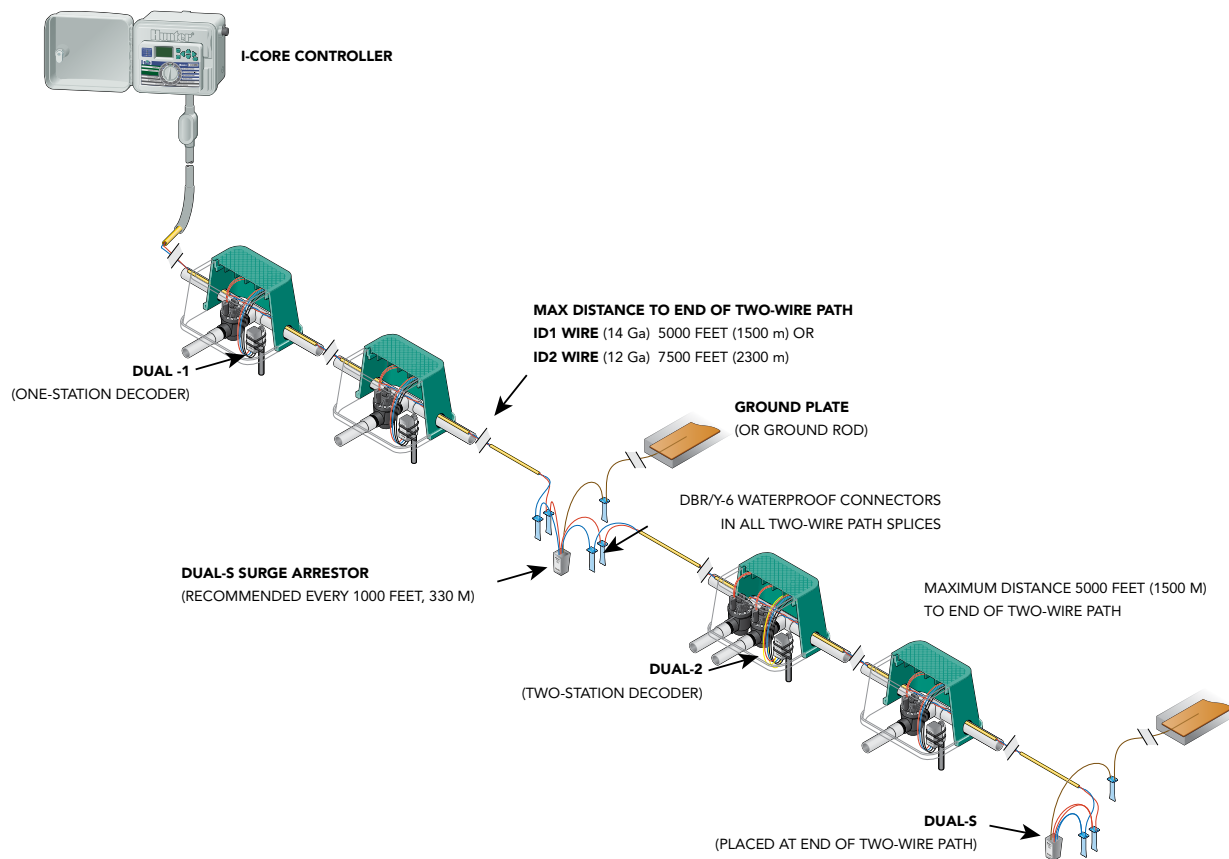

INSTALLATION OF DUAL DECODER MODULE

The DUAL48M decoder output module is designed for use in all Hunter I-CORE series controllers and provides two-wire decoder outputs for the Hunter DUAL family of field decoders.



NOTE: This module is not compatible with any other controller or any other type of decoder.

The decoder output module installs in the first three expansion slots of the controller. The station size of this module is 48 maximum.

1. Turn the dial to the Run position.
2. Open the facepack door, and locate the module slide lock. Slide the module lock to the unlocked "Power Off" position.
3. Remove any previously installed ICM-600 station output modules. Install the DUAL48M in the first 3 slots to the right of the Power Module. Do not attempt to force the module into any other position.
4. Install the module by aligning it in the first three expansion slots, and slide it in, pushing until the module is seated flush with the Power Module to the left.

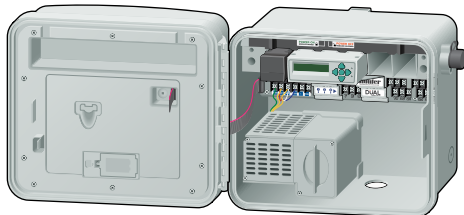

5. Slide the module lock to the locked "Power On" position. The I-CORE will apply power to the module and recognize it for decoder use (controller maximum station size is now 48 stations).



NOTE: The DUAL48M will display a line open message if the module is installed and no two-wire paths and decoders are wired to the controller.

Installation for Combined Decoder and ICM-600 Module

The I-CORE will accept both the DUAL48M decoder module and standard ICM-600 expansion modules (up to 2 additional ICMs in the plastic cabinet and up to 3 in the metal and plastic pedestal controllers), providing the ability to attach decoders and conventionally wired stations to the controller. The ICM-600 module(s) must be installed to the left of the DUAL Decoder Module with no gaps. The 48 station maximum does not change. The decoder module will automatically recognize the number of conventional stations (six per ICM-600). The "Avail Station" display will change to show the range of available decoder stations (for example, 7-48, 13-48, etc).

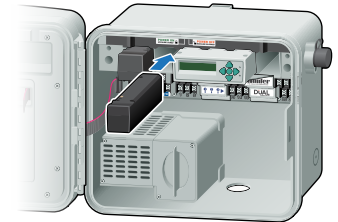

WIRE SPECIFICATIONS AND INSTALLATION

Wire and wire installation is a key factor in successful decoder installations. Substitution of recommended wire and wire splices is at the installer's own risk and is a major cause of start-up service troubles. Hunter provides two types of wire for use with I-CORE DUAL™ decoder systems.

ID1 WIRE: Two-conductor, solid-core, twisted, color-coded red and blue, direct burial PE jacket 14AWG/1.6 mm dia. copper wires. Suitable up to 5000 feet/1500 m.

ID2 WIRE: Two-conductor, solid-core, twisted, color-coded red and blue, direct burial PE jacket 12AWG/2.05 mm dia. copper wires. Suitable up to 7500 feet/2300 m.

The twisted pairs are not shielded or armored. Conduit is not necessary unless local regulations require it (the two-wire path is low voltage).

- Each two-wire output run of wire is called a "path". The DUAL48M provides up to three output paths to the field, and decoders may be installed on any or all of them in any combination.
- It is not necessary to connect the paths to one another. Each path runs from the controller to the last decoder in the path, and simply stops there.
- Never connect a wire path from one controller to the wire paths from another controller.

Hunter requires twisted wire meeting the listed specifications on all paths. The twist in the wire is an essential part of surge suppression. As lightning damage is never covered by warranty, it is in the installer's best interest to share what Hunter has learned in nearly two decades of decoder installations, by using twisted wire that meets all the above specifications. Wire may be substituted provided it meets or exceeds these specifications. The red/blue coding is a convenience for matching the wires to Hunter decoders. Color coding the two different conductors is mandatory.

Using Pre-Existing Wire

This is strongly discouraged by Hunter for the following reasons:

- It is unlikely that the pre-existing wire meets the specifications for gauge, twist, and solid copper.
- Pre-existing wire will not be color-coded correctly for the decoder wires.
- Pre-existing wire may have invisible problems (shorts, breaks, increased resistance, or damaged insulation) that will be inherited by the new installation.

ID WIRE TABLES

14 AWG/2 MM ² STANDARD DECODER CABLE (UP TO 5,000 FT./1,500 M)		12 AWG/3.3 MM ² LONG RANGE, HEAVY-DUTY DECODER CABLE	
ID1GRY	Gray jacket	ID2GRY	Gray jacket
ID1PUR	Purple jacket	ID2PUR	Purple jacket
ID1YLW	Yellow jacket	ID2YLW	Yellow jacket
ID1ORG	Orange jacket	ID2ORG	Orange jacket
ID1BLU	Blue jacket	ID2BLU	Blue jacket
ID1TAN	Tan jacket	ID2TAN	Tan jacket

TYPICAL WIRE LAYOUT

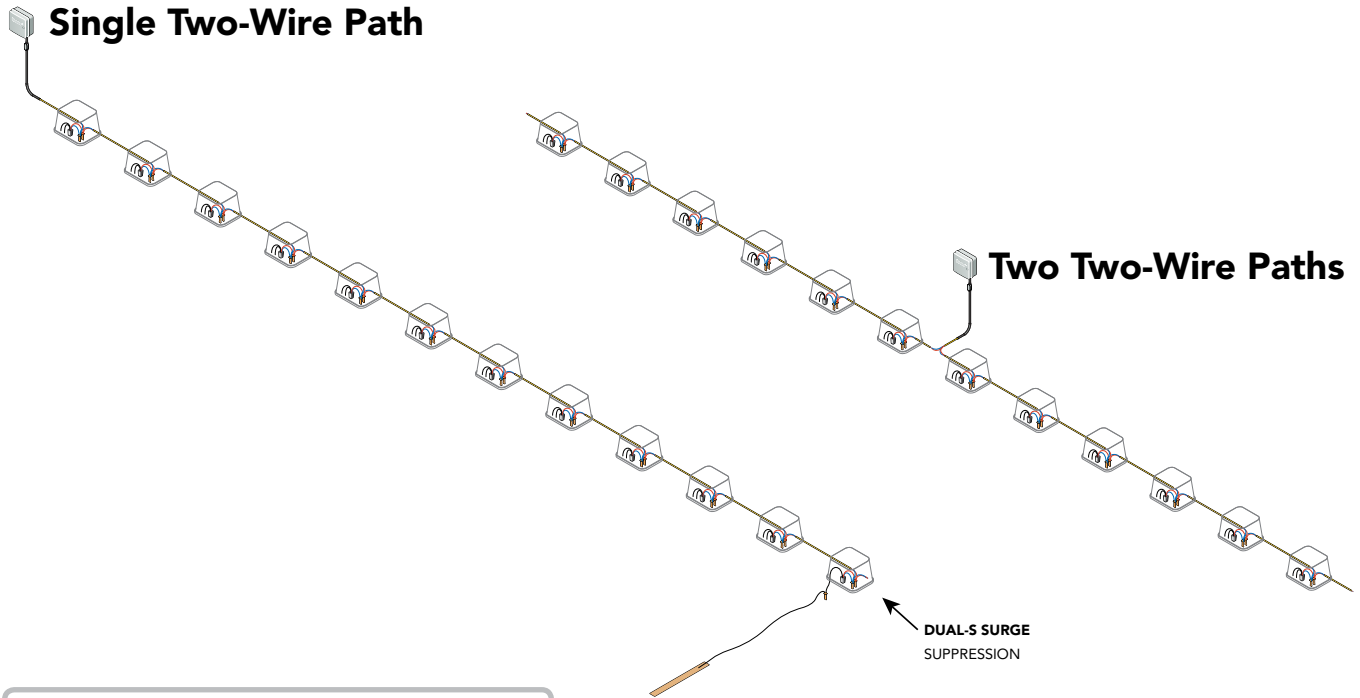

 **NOTE:** Do not loop the two-wire path back to the controller.

TYPICAL WIRE LAYOUT

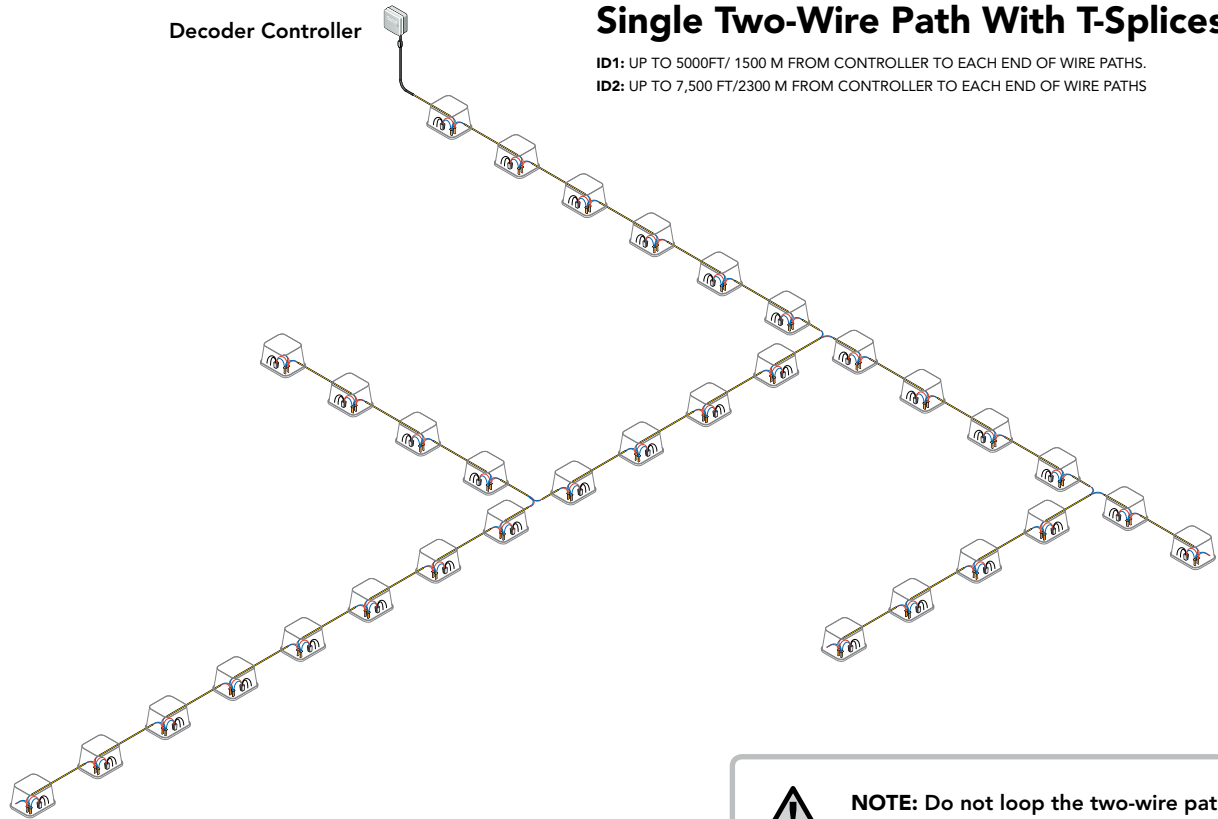

Single Two-Wire Path With T-Splices

ID1: UP TO 5000FT/ 1500 M FROM CONTROLLER TO EACH END OF WIRE PATHS.

ID2: UP TO 7,500 FT/2300 M FROM CONTROLLER TO EACH END OF WIRE PATHS



NOTE: Do not loop the two-wire path back to the controller.

WIRE SPECIFICATION AND INSTALLATION

Connecting the Two-Wire Paths

1. Turn Controller power OFF.
2. Route the red and blue wire paths from the field up through the wire openings or conduit into the controller wiring compartment.
3. Connect the red and blue two-wire paths to the decoder output screw terminals below the decoder module.
4. There are two rows of screw terminals in the controller that are accessed through an opening in the decoder module cover, one red and one blue, labeled 1-2-3. Each numbered pair represents a possible two-wire path to the field (some systems only use one pair, others may use all three).
5. Connect the red wire from a twisted pair to a numbered red terminal, and connect the blue wire to the blue terminal with the same number. Do not connect more than one wire to any of the terminals. Do not mix red from one pair with the blue from another pair. Keep each pair separate, red to red and blue to blue, until all pairs are connected to their numbered terminals.
6. Turn controller power back ON and test. The decoder output module display should show that it is ready for programming or operation.



NOTE: If decoder(s) have not been installed on the two-wire path(s), the decoder output module will display "Line Open".

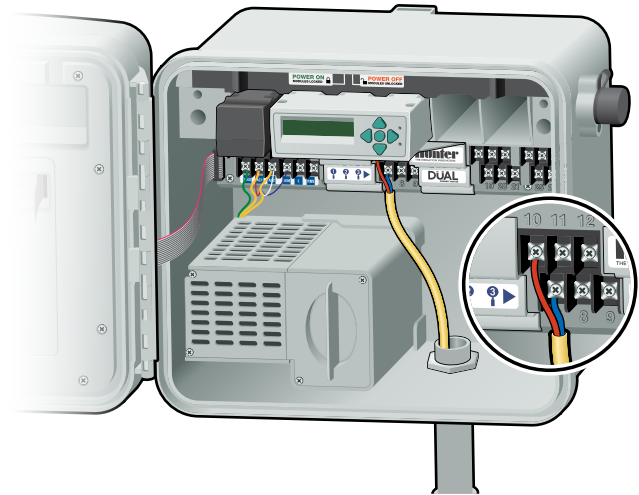

OVERVIEW OF DECODER PROGRAMMING

It is recommended that each decoder be programmed with station address(es) at the controller before installing it in the two-wire path. Decoders can also be programmed in the field with the Hunter ICD-HP Handheld Programmer, if available. Program the station number(s) into the decoders, and then write the station number assignments on the label on the decoders.

The decoder output module has two holes to the right of the programming buttons.

Before programming any stations, you should have an exact plan on paper for the location of each decoder and station in the system. DUAL decoders are available in one- and two-station sizes, and they may be mixed in the same system. The numbered station assignments for each decoder can be programmed for any station by the decoder module depending on the size of the decoder.



NOTE: Do not program the same station number into two different decoders!

Programing Decoder Stations

1. Turn controller power ON.
2. Insert the stripped end of the red wire from a DUAL decoder into one of the two Programming Ports to the right of the programming buttons on the decoder output module.



3. Insert the blue wire from the decoder into the other Programming Port hole.



NOTE: Do not let the wires touch each other.

4. Press the mode button (center button) ● once. An arrow will be displayed next to "Prog Decoder". The decoder is now ready to be programmed.
5. Press the ● button again. The display will show "Reading" as the decoder module checks for the presence of a decoder.



OVERVIEW OF DECODER PROGRAMMING

- The display will briefly show "Reading DONE" when the module has completed identification of the decoder.
- If the decoder red/blue wires are not fully inserted into the module, or if the decoder is defective, a "Reading ERROR" message will be displayed.

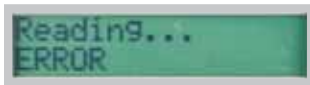

- Once the module has recognized the decoder, it is now ready to be programmed. Brackets [] indicate the station number for the decoder output. There will be two sets of brackets for a two-station decoder. (There may already be a number within the brackets indicating that the decoder has been previously programmed.)

A new decoder out of the box will be set to station 00, and new DUAL-2 decoders will have both stations set to 00.



- Use the ▲▼ buttons to select or change the station number you would like to program into the decoder.
- Press the ● button to begin the automatic programming procedure.

- The display will indicate when programming has been completed by showing "Programming DONE". If the decoder has been accidentally disconnected or malfunctions, the display will show "Programming ERROR". This means the decoder was not programmed (check connection, and try again).

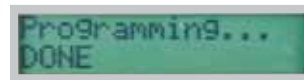

- If a two-station decoder is being programmed, use the ► button to navigate to the second set of brackets [] which indicate the station number for the #2 decoder output. Use the ▲▼ buttons to select the station number you would like to program.



- Press the ● button once and the module will conduct the automatic programming procedure for the #2 decoder output.
- Again, if the programming (of the decoder) is successful, the display will show "Programming DONE".
- When the decoder and stations have been programmed, the module display will return to the ready mode. It is recommended that you write the station numbers for each decoder output on the label provided on each decoder.

OVERVIEW OF DECODER PROGRAMMING



NOTE: Decoders may be reprogrammed at any time. If it is necessary to change the station numbers previously programmed into the decoder, the decoder may be reconnected to the Programming Port. The station number(s) will be displayed. Conduct the programming procedure outlined above to reprogram the decoder. The ICD-HP provides the convenience of reprogramming decoders without having to remove them from the two-wire path.

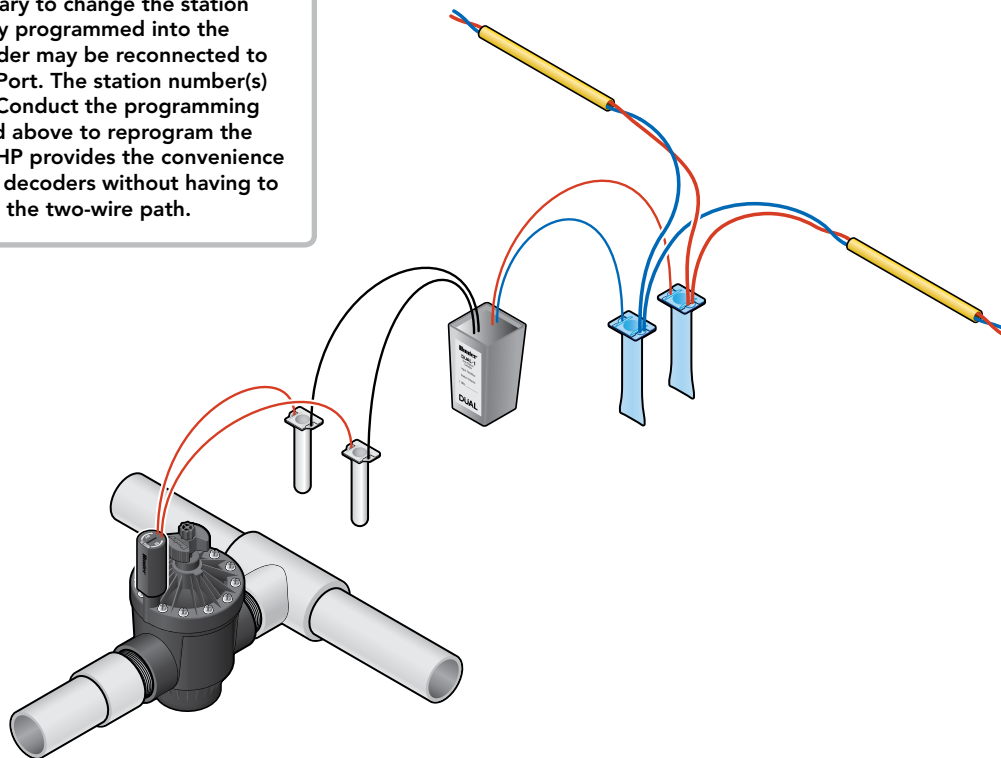

INSTALLING THE DECODERS

1. Controller power must be OFF when installing decoders in the two-wire path.



NOTE: Decoder wire runs and connections must be completely waterproof. Decoder wiring is more critical than "conventional" 24 VAC solenoid wiring. Follow instructions closely!

2. Select the decoder location (unless you are replacing an existing decoder). Decoders should be within 100 feet/33 m of the solenoids they will operate. Decoders are waterproof, but should be installed in a valve box to facilitate future service and increase longevity.
3. Locate the two-wire path. These are the red and blue wires coming from the controller. The wire path must be cut to insert decoder wiring, unless you are replacing an existing decoder.

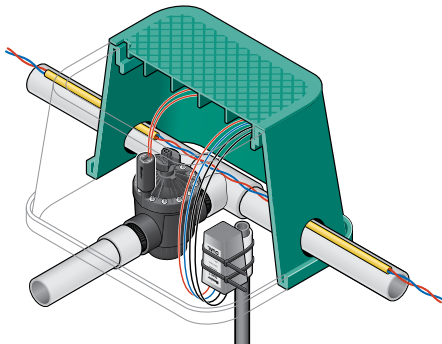

NOTE: Be sure to leave enough slack in the wire path to allow easy connection of the decoder and to allow for contraction of wiring due to temperature changes. Hunter recommends at least 5 feet/1.5 m slack for each decoder to allow it to be removed from the valve box completely for installation, service, and inspection.

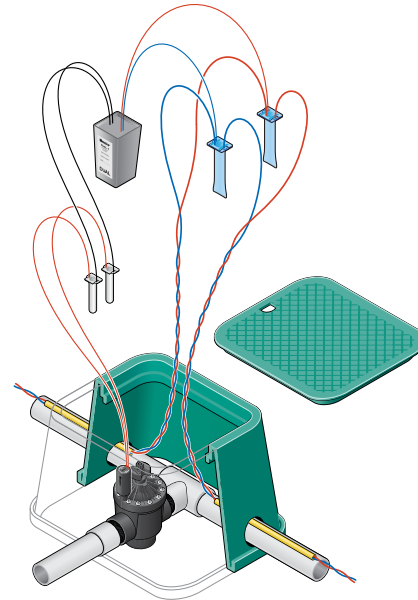

INSTALLING THE DECODERS

4. Identify the color-coded wires on the decoder. The red and blue wires connect to the red and blue wire path from the controller.
5. Strip the cut red and blue wire ends back approximately $\frac{3}{4}$ inch (2 cm).

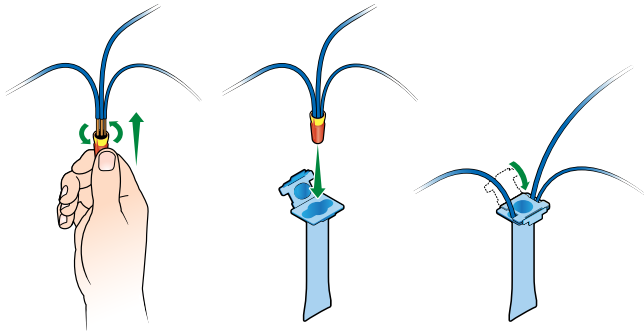

6. Twist the stripped red wire ends (the ends from the two-wire path and the decoder) together, and thread securely into the wire nut supplied with the decoder. Seal the connection by inserting the wire nut into the connector's waterproof grease until it snaps into place, and snap cap securely over wires.
7. Repeat with the blue wires: Connect the blue end(s) from the two-wire path with the blue wire from the decoder, and secure in a separate waterproof connector supplied with the decoder.

8. Each pair color-coded decoder output wires operates one or two solenoids up to 100 feet/33 m away (greater distances are possible, but increase susceptibility to lightning damage).
9. Strip the insulation and connect the two black wires from the decoder to the solenoid leads for the first station output. If a two-station decoder is being installed, strip back and connect the two yellow wires to the solenoid leads for the second station output. Insert and seal connections with DBY or equivalent waterproof connectors.
10. Always terminate each wire path with a DUAL-S surge suppression module. Do not leave unconnected stubs of the two-wire path beyond the last decoder. These may affect the current readings and cause incorrect fault messages.



NOTE: Each DUAL decoder output may operate two solenoids simultaneously. The solenoids must be connected in parallel, rather than in series. Each decoder output wire should make a three-way connection, with one wire from each of the two solenoids. Decoder outputs never use a "common" wire.

LIGHTNING PROTECTION AND GROUNDING

Proper grounding of decoder systems is part of the installation that requires consideration. Properly grounded decoder systems perform very well even in high-lightning regions. Poor grounding often results in unnecessary equipment losses and irrigation down time.

Earth grounding rules for the I-CORE decoder controllers are the same as for conventional I-CORE controllers. A large ground lug is provided for connection of bare copper wire to earth grounding hardware.

Hunter DUAL-S surge arrestors must be used on all DUAL two-wire systems. The DUAL-S surge arrestor attaches directly to the two-wire path to minimize the damage from lightning strikes. The amount of surge protection needed depends on how exposed the area is to lightning and on how well the installation needs to be protected. In addition to grounding the controller, the minimum recommended level of protection is one DUAL-S grounded at the end of each two-wire path and one DUAL-S grounded every 1000 feet/300 m or twelfth decoder. For higher levels of protection, attach surge arrestors more often.

Similar to the DUAL decoders, the DUAL-S is sealed from moisture and should be placed in its own valve box. It is important that both the controller and the surge arrestors are grounded to ground rods or plates with less than 10 ohms resistance. Use grounding electrodes that are UL listed or meet the minimum requirements of the National Electrical Code (NEC) as well as local codes. At minimum, the grounding circuit for controllers will include a copper clad steel ground rod, or copper ground plate.

Copper ground rods should have a minimum diameter of $\frac{3}{8}$ "/1.5 cm and a minimum length of 8 feet/2.5 m. These are to be driven into the ground at a location 8 to 10 feet/2.4 to 3 m from the equipment or wires connected to it, at right angles to the two-wire path.. Install all grounding circuit components in straight lines. When it is necessary to make bends, do not make sharp turns.

Copper grounding plate assemblies intended for grounding applications have minimum dimensions of 4" x 36" x 0.0625" (100 mm x 2.4 m x 1.58 mm). A 25-foot (8 m) continuous length (no splices allowed unless using exothermic welding process) of 6 AWG solid bare copper wire is to be attached to the plate using an approved welding process.

The earth-to-ground resistance measured should be no more than 10 ohms. If the resistance is more than 10 ohms, then additional ground plates and PowerSet® can be installed. It is required that the soil surrounding copper electrodes be kept at a minimum moisture level of 15 percent at all times by dedicating an irrigation station at each controller location.

DUAL-S Installation

DUAL-S surge arrestors should be installed at the end of every two-wire path and at intervals of 1000 feet/300 m or every twelfth decoder.

LIGHTNING PROTECTION AND GROUNDING

In-Line Surge Arrestor Installation

1. Controller power must be OFF when installing surge protection on the two-wire path.
2. Select the location for the DUAL-S surge arrestor.
3. Locate the two-wire path from the controller (typically red and blue wires). The wire path must be cut to insert the surge arrestor, unless you are replacing an existing arrestor.
4. Identify a pair of red/blue wires from the DUAL-S and connect one red wire to one red from one side of the two-wire path. Twist the red wires together and seal the connection with the waterproof connectors supplied. Repeat for the blue wire.
5. Connect the second pair of red/blue wires from the DUAL-S to the other side of the two-wire path. Seal the connections with the waterproof connectors supplied.
6. Attach grounding device to the copper wire from DUAL-S using manufacturer's installation recommendations. Wire to ground hardware must be run at right angles to the two-wire path, a minimum of 8 feet/2.5 m away from the wire path. The ground hardware should not be in the same valve box as the surge suppressor.

End of Line Surge Arrestor Installation

1. Controller power must be OFF when installing surge protection in the two-wire path.
2. Locate the end of the two-wire path from the controller (typically red and blue wires).
3. Identify the two pair of red/blue wires from the DUAL-S surge arrestor. Twist the three red wires together and thread them securely into the wire nut supplied. Seal the connection by inserting the wire nut into the connector's waterproof grease, and snap the cap over the wires.
4. Repeat the procedure for the blue wires.
5. Attach ground plate or ground rod to the bare copper wire from the DUAL-S per manufacturer's installation recommendation.

LIGHTNING PROTECTION AND GROUNDING

In-Line Surge Arrestor Installation

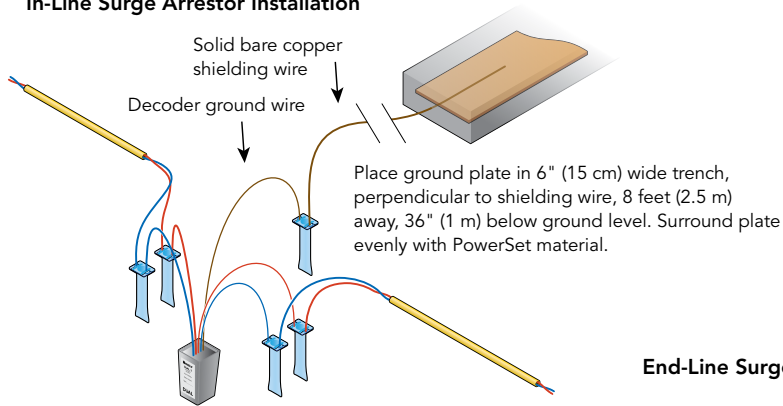

End-Line Surge Arrestor Installation

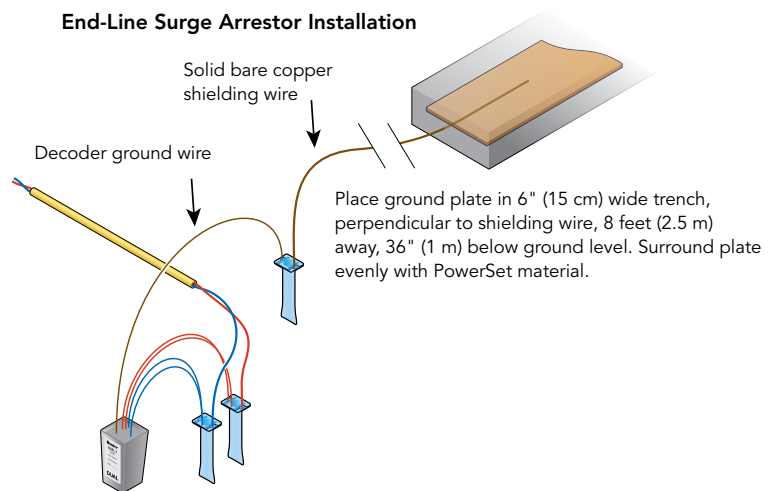

DIAGNOSTICS

The DUAL decoder module has features and diagnostics to help you troubleshoot installation issues and check the status of solenoid operation. Basically, two functions are available to the user in the Diagnostic mode:

Read Current Function

Allows for real time current readings of solenoids operating on the two-wire path.

1. Use the ▲▼ buttons to select the "Read Current" function. Press the ● button once and the display will show the current draw on the two-wire path.

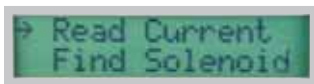

2. The display will show current in milliamps (mA). The display shows typical current draw for a single solenoid.



Find Solenoid Function

The "Find Solenoid" function allows the users to activate the solenoid of a single station in a mode that produces a "chattering" sound. This function allows for quick identification of valves on the site.

1. Use the ▲▼ buttons to select the station you would like to operate in the "Find Solenoid" mode.

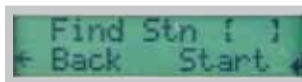

2. Press the ● button once to initiate. The module will "chatter" the solenoid for 60 seconds. Use the ● button at any time to stop the "Find Solenoid" function.

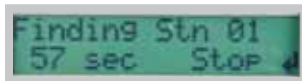

Operating Stations

The I-CORE controller can operate two programs simultaneously or up to five solenoids in the manual station operation model. At any time the controller is operating stations, the station numbers will be displayed.

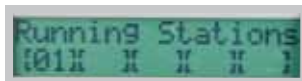

TROUBLESHOOTING

Important tools

#2 Phillips screwdriver,

Calculator

ICD-HP Handheld Programmer

Known-good solenoid

Known-good decoder

Digital Multimeter

ICD-HP Handheld Wireless Programmer



This Hunter product allows wireless connection with DUAL decoders, even when they are wired into field installations. The ICD-HP allows direct diagnostics, operation, and programming of any DUAL decoder installed in a valve box. ICD-HP can also verify status of solenoids, read voltage, and test sensors. The ICD-HP is highly recommended for field troubleshooting and will pay for itself in greatly reduced setup, programming, and diagnostic time.



Faults and Fault Messages

Faults: Controller display shows "Fault". This may be followed by a station number.

The Station Status light on the ICore System Status dashboard will also show a red LED when there has been a decoder fault.



NOTE: Fault light and message are only visible when stations are not running. During active irrigation, the Fault will not be visible.

If one or more station numbers are listed on the display, troubleshoot those stations. If there is no station number, troubleshoot the two-wire path connections.

1. Open the controller inner door to see additional diagnostic information on the DUAL48M display. The display may show Line Open or Line Fault.

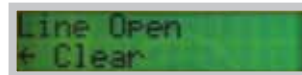

The message may alternate with other screens. Allow a few seconds to see all displays.

TROUBLESHOOTING

2. Press the Mode (center) button on the DUAL48M control panel. Select "Diagnostics" with the ▲▼ arrows, and press Mode to select.
3. Press the Mode button to select "Read Current". This will show the current draw in milliamps (ma). In standby (no stations running), the total should be approximately 3-4mA multiplied by the number of decoders in the system. The number of decoders on the two-wire paths determines the correct current for the system.



When a station is turned on, the milliamps should increase by approximately 40mA, per solenoid attached to the active station.

- If a station is turned on, and the milliamps don't increase enough, the controller will show a Station Fault followed by the station number.
- If a station is turned on, and the milliamps increase by more than the controller will allow, the controller will show a Station Fault followed by the station number.
- If the milliamps increase too much when no stations are supposed to be running, the controller will show a Fault with no station number.

4. Observe the current draw with no stations running. Divide the current draw by the number of decoder modules connected to the controller. It should be approximately 3-4 mA per decoder.
 - Do not include DUAL-S surge suppression devices in current draw calculations- they do not increase the current.
5. If no problem is observed with the current draw reading in standby (no stations running), turn on a station listed in the Fault message with the Manual Single Station feature, or a wireless remote control.
6. Observe the Current Draw display. The current should increase by approximately 40 milliamps per solenoid connected to the decoder. Wait at least 30 seconds for the controller to complete its retry attempts and for the current to stabilize.

TROUBLESHOOTING

Line Fault: If the DUAL48M says “Line Fault” when no stations are running, the most likely cause is a direct short between the two wires in the two wire path (red and blue). If the Line Fault message only appears when a station is turned on, the problem is most likely a short in the decoder-to-solenoid wiring for the affected stations.

ICore Display	DUAL48M display in Standby	Cause	Corrective Action
Fault, no station	Line Open: Current draw too low on standby	Two-wire path disconnected	Check connections to two wire path
	Line Fault: Current draw too high on standby	Short in two-wire path Too many decoders (more than 48) in two-wire path	Check two-wire path (red and blue must not touch) Verify number of decoders in two-wire path
Fault with station numbers	DUAL48M display with Active Station	Cause	Corrective Action
	Current Draw for station too low (station number will blink slowly) *	Decoder not programmed Decoder missing, damaged, or disconnected Solenoid missing, damaged, or disconnected	Program decoder address Repair/replace decoder or connections Repair or replace solenoid or decoder-to-solenoid wiring
	Current Draw for station too high (Line Fault will appear when station is running)	Shorted solenoid or solenoid wiring Multiple decoders with same address Too many solenoids connected	Repair/replace solenoid or decoder-to-solenoid wiring Remove duplicate addresses Remove excess solenoids

TROUBLESHOOTING

*** Current Draw Too Low:** In a low current situation, the controller will retry the command to the station up to 3 times.

The DUAL48M display will show the station number when it is sending the command to the decoder.

If the current does not increase, the station number will disappear for a few seconds. This indicates that the draw did not increase as expected.

After 4-5 more seconds, the station number will re-appear, during the retry attempt.

If low current draw continues, the number will disappear again.

After 3 unsuccessful attempts, the station number will disappear, and the Fault message will appear on the ICore controller facepack display.

The slow blink of the station number is an indication that either the specified decoder, or its solenoids, are not connected or operational.

When a healthy decoder and solenoid are activated, there is no need for the retry attempts, and the station number will not appear to blink.

If No Stations Will Activate:

1. Verify that slide lock is in the Power On position and that power is on to the DUAL48M module (display appears).
2. Check DUAL48M for "Line Open" message. This means the two-wire path is disconnected from the controller.
3. Check between the controller and the first decoder to verify that the two-wire path is connected.

If No Stations Will Activate Beyond a Certain Station Number (followed by multiple station faults): Likely break in two-wire path beyond station 1.

1. Identify failing stations from Fault messages.
2. Identify decoder locations and layout on plan or in wiring path.
3. Begin with last working station, and look for break beyond that point.
4. If multiple two-wire paths are in use, disconnect other paths, and troubleshoot one path at a time.

TROUBLESHOOTING

Clear Fault Alarms:

Press the – button on the ICore facepack to clear the Fault message and/or Alarm light.

Special Notes:

ICore Decoders are not compatible with mechanical relays.

When combining DUAL48M with conventional ICore station output modules, not all stations will be available for decoder addressing. The station numbers for slots with ICM-600 modules will not be available for decoder station programming.

Voltage measurement between an active decoder and the solenoid is not a reliable indicator of the output from a decoder.

- Decoder electrical power is not the same as 50/60 Hz power and normal voltmeters may show very low readings to active stations (may range from 5 to 14 Volts).
- It is more reliable to keep a known-good decoder, and a known-good solenoid, for troubleshooting purposes.

Controller may temporarily fault Open if only one decoder is connected to the two-wire path, since standby current may fluctuate below the minimum. Correct by either waiting 5 minutes for line to stabilize, or connecting a second decoder.

Stations turned on in the field with ICD-HP may shut down prematurely, because the controller is unaware of the decoder activation. To prevent this, start another station via the controller or remote control anywhere in the system.

NOTES

NOTES

Hunter®

Hunter Industries Incorporated • The Irrigation Innovators
1940 Diamond Street • San Marcos, California 92078 USA
www.hunterindustries.com

© 2010 Hunter Industries Incorporated
LIT-533 9/10