

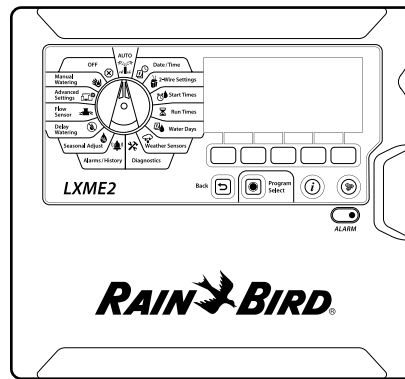

LXME2

Series Controllers

Installation, Programming & Operation Guide



CAUTION:

This appliance is not intended for use by persons (including children) with reduced physical, sensory or mental capabilities, or lack of experience and knowledge, unless they have been given supervision or instruction concerning use of the appliance by a person responsible for their safety.

Children should be supervised to ensure that they do not play with the appliance.

For controllers not provided with supply cord, the fixed installation must include a disconnecting device for all three poles suitable for overvoltage category III protection.

▲ WARNING:

The LXME2 controller must be properly surge protected and grounded. Doing so can help prevent damage to the controller and irrigation system and also significantly reduce troubleshooting, repair time and expense. Failure to do so could result in failure of your controller and voiding the warranty.

Electric shock can cause severe injury or death. Make sure power supply is turned OFF before connecting power wires.





All electrical connections and wiring runs must be made according to local building codes.







The current date and time on the controller is retained by a long-life lithium battery, which must be disposed of in accordance with local regulations.



This controller uses a non-replaceable lithium battery. Lithium batteries are hazardous and can cause severe or fatal injuries in 2 hours or less if it is swallowed or placed inside any part of the body. Medical attention should be sought immediately if this is suspected. Keep batteries away from children



CONTENTS

1. INTRODUCTION	5
1.1 LXME2 Controller Overview	5
1.2 Controller Features	5
1.3 In the Box.....	6
1.4 Regulatory Compliance.....	6
1.5 Valves (Stations).....	7
1.6 Programming Overview.....	7
1.6.1 Programs	7
1.6.2 Storing the Quick Start Guide.....	7
1.6.3 Remote Programming.....	7
1.7 Interface Overview.....	8
1.8 Programming Checklist.....	9
1.8.1 Set Up Hardware	9
1.8.2 Set Up Programs	9
1.8.3 Set Up Advanced Programming (Optional)	9
1.8.4 Review Setup	10
1.8.5 Additional Advanced Programming (Optional)	10
2.  AUTO	11
2.1 Alarms	12
3.  Set Date/Time	13
4.  Setup.....	14
4.1 Master Valves.....	14
4.2 Weather Sensors.....	20
4.3 Station Setup	21
4.3.1 Station Priority.....	21
4.3.2 Master Valves/ Pumps	22
4.3.3 Weather Sensors	22
4.3.4 Valves Per Station	23
4.3.5 Flow Sensors - PRO Models only.....	23
4.4 Advanced Station Settings.....	27
4.4.1 Cycle + Soak (Advanced Station Settings)	27
4.4.2 Copy Station To Station.....	28
4.4.3 Station Delay (Advanced Station Settings)	28
4.4.4 SimulStations (Advanced Station Settings).....	29
4.4.5 Station Sequencing (Advanced Station Settings).....	30
4.4.6 Module/ Station Numbering (Advanced Station Settings).....	32
5.  Set Start Times	33
6.  Run Times.....	34

6.4.1	Copy Run Times	35
7.	 Water Days	36
7.4.1	Custom, By Day of Week	36
7.4.2	Cyclic Days	37
7.4.3	Even days, Odd days, Odd no 31st	38
8.	 Weather Sensors	39
9.	 Diagnostics	40
9.4.1	Test all Stations	40
9.4.2	Raster Wiring Test	40
9.4.3	Confirm Programming	41
9.4.4	Program Summary	41
9.4.5	Review Programs	43
9.4.6	Program Run Times	45
9.4.7	Station Run Times	46
9.4.8	Master Valve Status	47
9.4.9	Weather Sensor Status	47
10.	 Alarms/ History	48
10.4.1	Flow History.....	48
10.4.2	Clear Flow History	48
10.4.3	Flow Alarms.....	49
11.	 Seasonal Adjust	51
11.4.1	Individual Program	51
11.4.2	By Month.....	51
12.	 Delay Watering.....	54
12.4.1	Rain Delay	54
12.4.2	Calendar Day Off	54
12.4.3	Program Water Window	55
12.4.4	Water Window Set Up.....	56
13.	 Flow Sensor	57
13.4.1	Introduction to Flow.....	57
13.4.2	FloZones Overview	57
13.4.3	Flow Management Features.....	57
13.1	Flow Sensors	57
13.1.1	Selected Stations	59
13.1.2	Set Station Rates.....	61
13.1.3	Set FloZone Rates	62
13.1.4	View Flow Rates	62
13.1.5	View FloZone Rates	64
13.1.6	Clear Flow Rates.....	64
13.1.7	Set Flo-Manager®.....	65
13.1.8	Flo-Manager® Set Up.....	65

13.1.9	Enable or Disable Flo-Manager®	65
13.1.10	Set FloWatch™	65
13.1.11	FloWatch™ Set Up	66
13.1.12	FloWatch™ On/Off	67
13.1.13	Set Flow Limits	67
13.1.14	Set Up and Configure High Flow and Low Flow	68
13.1.15	Set Flow Actions	69
13.1.16	Current Flow Reading	69
13.1.17	Set Flow Units	70
14.	 Advanced Settings	71
14.1.1	Store/ Recall Programs	71
14.1.2	Factory Defaults	75
14.1.3	About this LXME2	76
15.	 Manual Watering	77
15.1.1	Start Station	77
15.1.2	Start Program	78
15.1.4	MV (Master Valve) Water Window	78
15.1.5	Manual MV Open	80
16.	 OFF	81
16.1.1	Adjust Display Contrast	81
16.1.2	Close Master Valves	81
17.	Installation	82
17.1	Install the Controller	82
17.1.1	Installation Checklist	82
17.1.2	Check Box Contents	82
17.2	Select Location for Controller	83
17.2.1	Gather Installation Tools	83
17.2.2	Access Controller Cabinet	84
17.3	Mount the controller	85
17.4	Connect source power	85
17.4.1	Install base and station module (BCM or PSM)	86
17.4.2	Install Station Module	86
17.5	Dynamic Station Numbering	87
17.5.1	Connect Field Wiring	88
17.5.2	Connect Local Weather Sensor	88
17.5.3	Connect a Flow Sensor - PRO Models Only	89
17.5.4	Verify Field Installation	90

1.3 In the Box

- LXME2: controller, Base module, 12 station module
- Mounting hardware (5 screws, 5 plastic wall anchors)
- Controller cabinet keys
- Controller mounting template
- Quick Start (including Programming Guide)
- Station Numbering Labels
- Wire nuts

1.4 Regulatory Compliance

- 120VAC models UL, FCC, ISED.
- 230VAC models CE, UKCA, ACMA RCM.

1.5 Valves (Stations)

Valves, or stations are controlled and operate according to irrigation programs.

The controller is programmed to send signals to valves, which open and close on a timed schedule.

When a program is finished, the controller shuts off that valve and provides electrical signal for the second valve to open and so on.

1.6 Programming Overview

1.6.1 Programs

The controller opens and closes valves according to a program you set. Each program contains:

Watering Start Times

The time(s) of day when the first station is programmed to begin watering; all other stations in the program then follow in sequence. See "[Set Start Times](#)" for more details.

Station Run Times

The length of time in hours and minutes that each individual station is programmed to run. See "[Run Times](#)" for more details.

Watering Days

The days of the week or calendar dates on which irrigation is allowed. See "[Water Days](#)" for more details.

Programming Guide

Before you begin programming, fill out the Programming Guide, this is located at the back of the Quick Start Guide.

Enter information about your system hardware and settings in the appropriate fields on the Programming Guide.

1.6.2 Storing the Quick Start Guide

Return the Quick Start Guide to a permanent, safe location when you're finished working with it. We recommend hanging it on the hook inside the controller cabinet door as shown below.

1.6.3 Remote Programming

The LXME2 controller can be programmed while operating under battery power.

This feature is useful if the controller is installed in an area that is not easily accessible. It also lets you enter program information before installing the controller at the job site.

1.7 Interface Overview

Controls, Switches and Indicators of the LXME2 Controller:

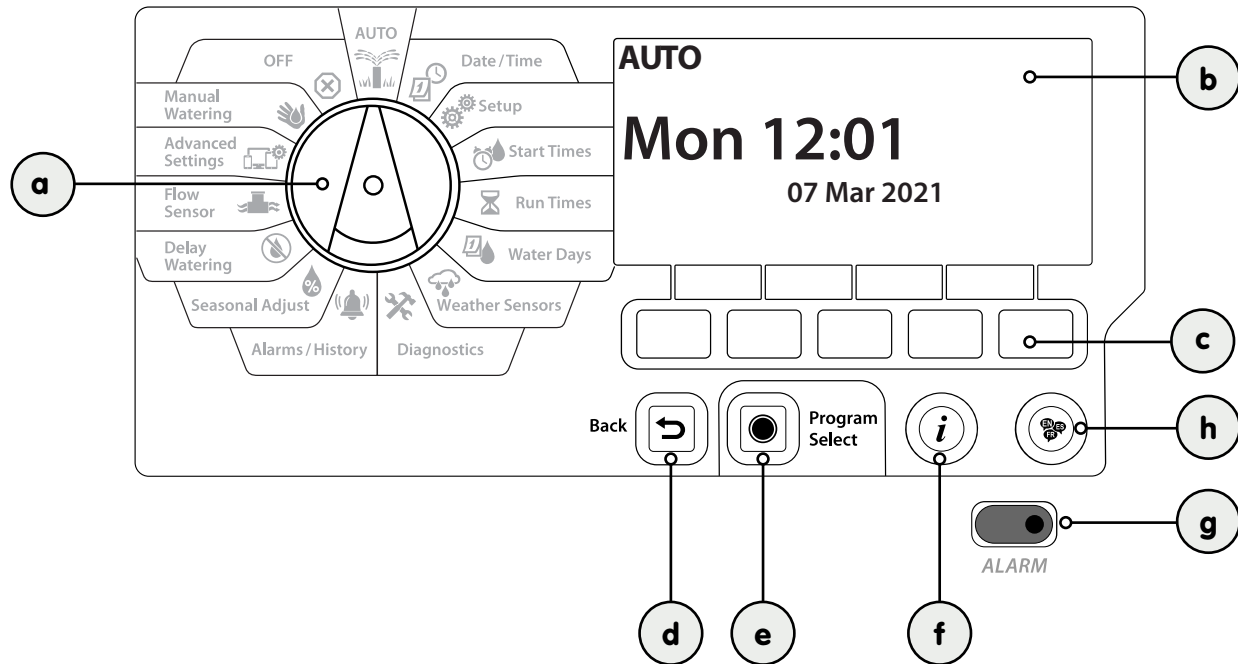

a	Programming Dial	Used to select irrigation features, programming and to turn the controller on and off .
b	Display	Displays time of day during normal operation; commands during programming, active station and remaining run time during watering as well as other status messages and alarms.
c	Programming Keys	Press buttons to navigate, enter and change program information. The function of each button is labelled on the display above.
d	Back Button	The back button will take you back to the previous menu screen of the currently selected dial position.
e	Program Select Button	Pressing the Program Select Button will show you the currently selected program and allow you to select another using the programming buttons. Always begin programming by selecting the desired Program (1-40). Multiple programs allow you to set watering schedules to meet different requirements for plant materials, soils, slopes, and shady or sunny areas.
f	Information Button	Pressing the Information Button In the Auto and Diagnostics dial positions will provide contact information for Rain Bird Technical Support. In the other dial positions this button provides a description of the currently selected dial position and menu screen.
g	Alarm Light	When an alarm condition is detected, the alarm light will illuminate. With the programming dial set to 'Auto', press the Alarm button (left most Programming Button) to view alarm details. Any current alarm conditions will then be displayed on the display. Take the appropriate action to address each alarm condition. When all alarms have been addressed, the alarm light on the front panel will no longer be illuminated.
h	Language Button	Press the Language Selection Button to change the interface language. Choose from English, Spanish, French, German, Portuguese or Italian.

1.8 Programming Checklist

When programming the LXME2 controller for the first time, it is recommended that you complete the following steps in order.

1.8.1 Set Up Hardware

Install Base Module (BCM or PSM)	<input type="checkbox"/>
Install Station module[s]	<input type="checkbox"/>
Fill out Programming Guide	<input type="checkbox"/>
Clear program information	<input type="checkbox"/>
Select language	<input type="checkbox"/>
Set the current date and time	<input type="checkbox"/>
Set up master valves/ pumps (optional)	<input type="checkbox"/>
Set up weather sensors (optional)	<input type="checkbox"/>
Set up stations	<input type="checkbox"/>
Set up a flow sensor (optional)	<input type="checkbox"/>

1.8.2 Set Up Programs

Select program	<input type="checkbox"/>
Set watering start times	<input type="checkbox"/>
Select watering days *	<input type="checkbox"/>
Set station run time(s)	<input type="checkbox"/>

* See [Watering Days](#) dial position for Odd, Odd31, Even and Cyclical watering cycles.

1.8.3 Set Up Advanced Programming (Optional)

Set seasonal adjust	<input type="checkbox"/>
Create a water window	<input type="checkbox"/>
Set up a station delay	<input type="checkbox"/>
Set up Simulstations	<input type="checkbox"/>

2. AUTO

AUTO is the normal operating mode. Programmed irrigation will run automatically with the controller dial set to AUTO.

If you forget to return the dial to AUTO, the controller will automatically continue to run programs, unless the dial is set to the OFF position when all irrigation is cancelled.

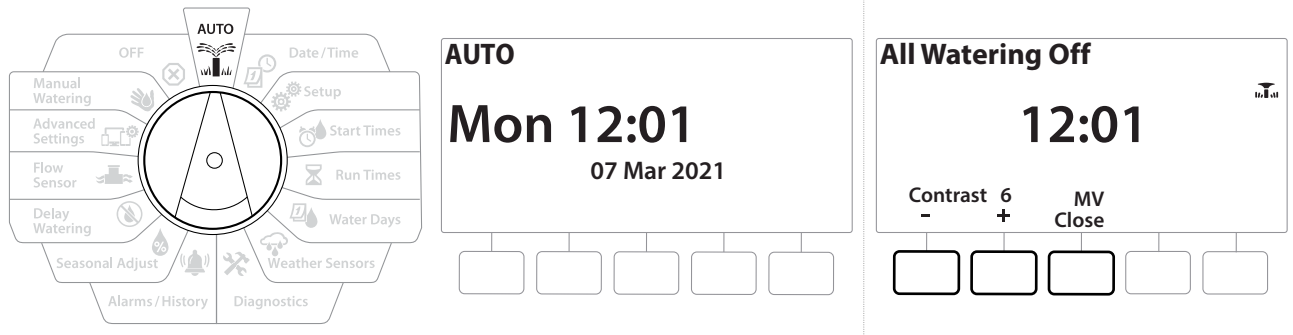

- 1 Turn the controller dial to AUTO
- 2 The Auto screen is displayed with the current day and time shown.
- 3 When a program is running in AUTO mode, the station number will show on the screen. Press the **+** and **-** keys to add or subtract minutes from the run time for the currently running station. To advance to the next station in a program, press the **Adv** key.
- 4 To cancel a currently running program, turn the controller dial to OFF for three seconds and then return the dial to AUTO.

2.1 Alarms

 An alarm condition can occur when programming omissions or other issues prevent normal irrigation.

- 1 Turn the controller dial to AUTO
- 2 When an alarm condition is present, the Alarm key label will be present on screen. The alarm indicator will also be lit red, this will be visible even with the lid closed. Press the **Alarm** key to view alarm details.
- 3 Any present alarm conditions will then be shown. Press the **More** key to continue to the next page

 *Take the appropriate action to address each alarm condition. When all alarms have been addressed, the alarm light on the front panel will no longer be illuminated.*

Alarm	Condition
No Water Days	There are no water days set in any program.
No Run Times	There are no run times set in any program.
No Start Times	There are no start times set in any program.
No PGM will AUTO Run	There is no program with start times, run times and water days.
Max PGMs Stacked	Max is 10 (equal to the start times).
Flow Alarm	Shows for high or low flow conditions. See " Flow Alarms " for more details.
Zero Learned Flow	0 flow is learned for 1 or more stations FloWatch is turned on. See " Set Flo-Manager " for more details.
Invalid Module	An incompatible module is installed in the cabinet.
No AC power	The panel is running on the 9V battery (no AC).

3. **SET DATE/TIME**

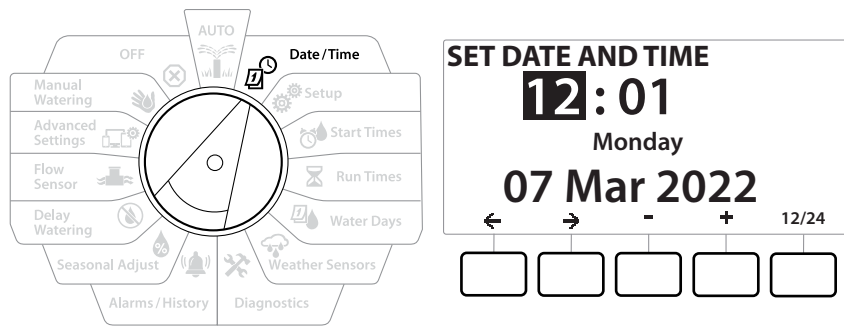

- 1 Turn the controller dial to Date/Time
- 2 At the SET DATE AND TIME screen, press the + and - keys to set the current hour, then press →

 *Press and HOLD keys to accelerate settings.*

- 3 Press the + and - keys to set the current minute, then press →
- 4 Press the + or - keys to set AM or PM, then press →

 *The time will automatically updated once the current day, month and year entered.*

- 5 Press the + and - keys to set the current date, then press →
- 6 Press the + and - keys to set the current month, then press →
- 7 Press the + and - keys to set the current year, then press →
- 8 Press the 12/24 key to change the clock format from American standard to Military standard
- 9 Proceed to the next dial position "[Setup](#)" to continue programming

 *The date will automatically updated once the current day, month and year entered.*

4. **SETUP**

The Setup dial position allows you to set up master valves, station valves, sensors as well as stations.

4.1 **Master Valves**

Master Valves Setup tells the LXME2 controller if a Master Valve (MV) or pump, or both is used by your irrigation system.

The Master Valve can be configured either as a Normally Open Master Valve (NOMV) or as a Normally Closed Master Valve (NCMV).

PRO Models only

MV2/P can be configured only as a pump start or Normally Closed Master Valve (NCMV).

MV2/P can be turned on and off by station but always operates in conjunction with MV1.

Configuration 1: *Single NCMV Master Valve*

STA 002 irrigating

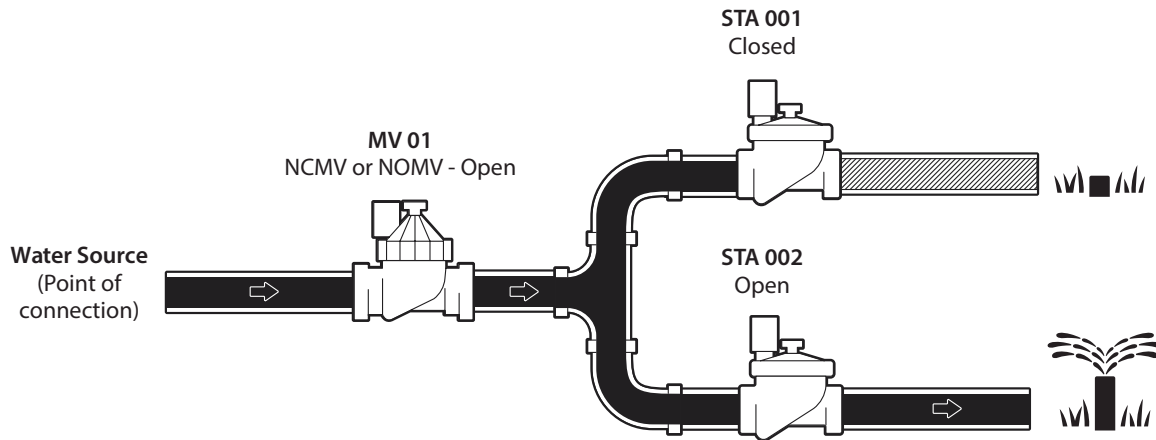

Master Valve Setup

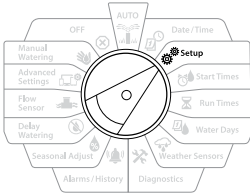

<p>SETUP</p> <p>Master Valves Weather Sensors Station Setup Flow Sensors Advanced Station Settings</p> <p>↑ ↓ Next</p>	<p>Master Valve Setup</p> <p>01 MV</p> <p>- + Next</p>	<p>Master Valve Setup</p> <p>MV 01 NCMV (only open when stations operate)</p> <p>↑ ↓ - + Done</p>	<p>Master Valve Setup</p> <p>MV 01 Number of Valves 1</p> <p>- + Done</p>
---	--	--	---

Station Setup

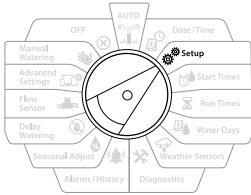

<p>SETUP</p> <p>Master Valves Weather Sensors Station Setup Flow Sensors Advanced Station Settings</p> <p>↑ ↓ Next</p>	<p>Station Setup</p> <p>001 STA</p> <p>- + Next</p>	<p>Station Setup</p> <p>STA 001 Set Priority Master Valve/Pumps Weather Sensors Valves Per Station</p> <p>↑ ↓ Next</p>	<p>Master Valve/ Pump Setup</p> <p>STA 001 MV1 NCMV Yes MV2 Unused ----</p> <p>↑ ↓ - + Done</p>
<p>Station Setup</p> <p>002 STA</p> <p>- + Next</p>	<p>Station Setup</p> <p>STA 002 Set Priority Master Valve/Pumps Weather Sensors Valves Per Station</p> <p>↑ ↓ Next</p>	<p>Master Valve/ Pump Setup</p> <p>STA 002 MV1 NCMV Yes MV2 Unused ----</p> <p>↑ ↓ - + Done</p>	

Configuration 2: NCMV Master Valve & Pump - **PRO** Models only

STA 002 irrigating

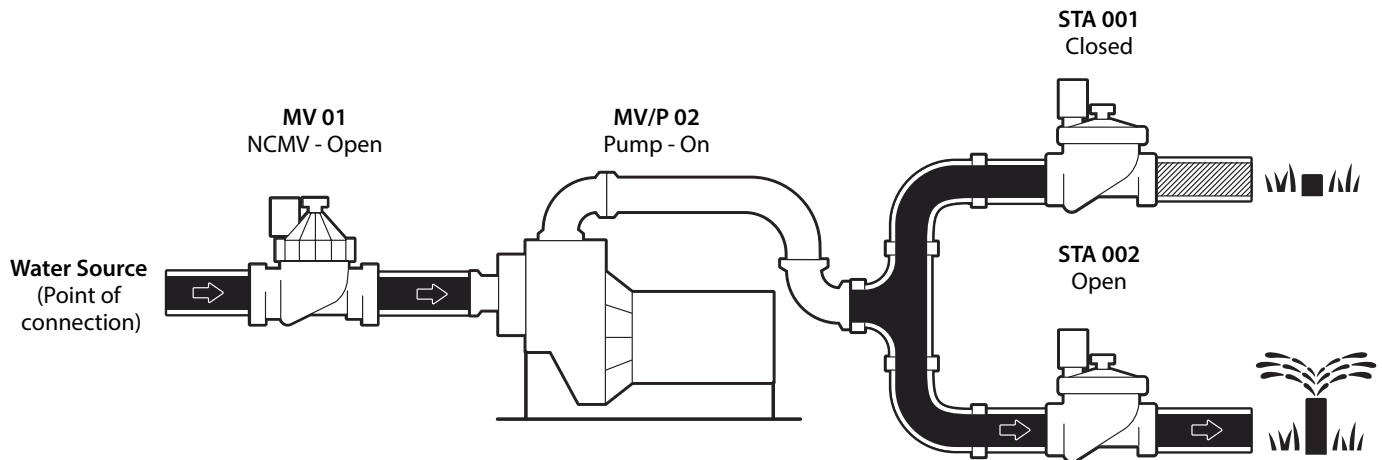

Master Valve Setup

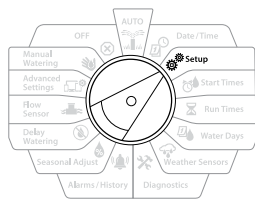

SETUP Master Valves Weather Sensors Station Setup Flow Sensors Advanced Station Settings	Master Valve Setup 01 MV	Master Valve Setup MV 01 NCMV (only open when stations operate)	Master Valve Setup MV 01 Number of Valves: 1
Master Valve Setup 02 MV/P	Master Valve Setup MV/P 02 Pump (only on when stations operate)	Master Valve Setup MV/P 02 Number of Valves: 1	

Station Setup

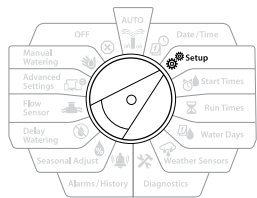

SETUP Master Valves Weather Sensors Station Setup Flow Sensors Advanced Station Settings	Station Setup 001 STA	Station Setup STA 001 Set Priority Master Valve/Pumps Weather Sensors Valves Per Station	Master Valve/ Pump Setup STA 001 MV1 NCMV Yes MV2 Pump No
Station Setup 002 STA	Station Setup STA 002 Set Priority Master Valve/Pumps Weather Sensors Valves Per Station	Master Valve/ Pump Setup STA 002 MV1 NCMV Yes MV2 Pump Yes	



Refer to the following section for guidance on [flow sensor setup](#).

Configuration 3: Two Water Sources, MV1 & MV/P 02 Operating as NCMVs - **PRO** Models only

STA 001 irrigating

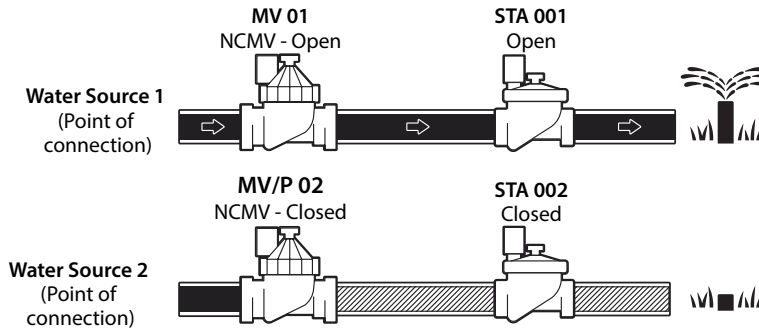

STA 002 irrigating

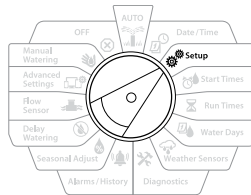
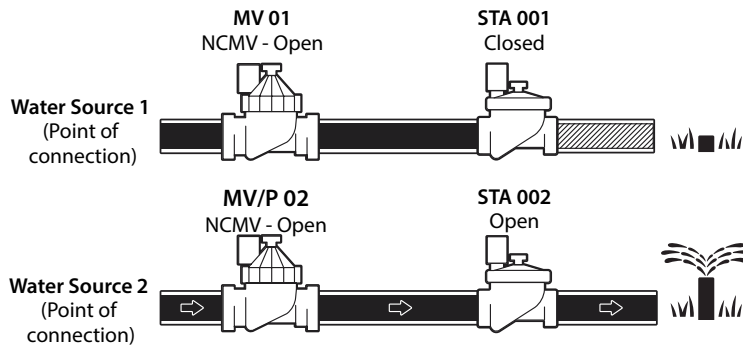

SETUP Master Valves Weather Sensors Station Setup Flow Sensors Advanced Station Settings	Master Valve Setup 01 MV	Master Valve Setup MV 01 NCMV (only open when stations operate)	Master Valve Setup MV 01 Number of Valves: 1
	Master Valve Setup 02 MV/P	Master Valve Setup MV/P 02 Pump (only on when stations operate)	Master Valve Setup MV/P 02 Number of Valves: 1

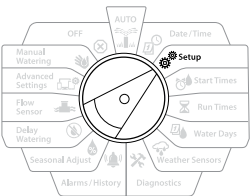

SETUP Master Valves Weather Sensors Station Setup Flow Sensors Advanced Station Settings	Station Setup 001 STA	Station Setup STA 001 Set Priority Master Valve/Pumps Weather Sensors Valves Per Station	Master Valve/ Pump Setup STA 001 MV1 NCMV Yes MV2 Pump No
	Station Setup 002 STA	Station Setup STA 002 Set Priority Master Valve/Pumps Weather Sensors Valves Per Station	Master Valve/ Pump Setup STA 002 MV1 NCMV Yes MV2 Pump Yes



Refer to the following section for guidance on [flow sensor setup](#).

- 1 Turn the dial to Setup
- 2 At the SETUP screen, with "Master Valves" selected, press **Next**.
- 3 At the Master Valve Setup screen, press the **+** and **-** keys to select the desired Master Valve press **Next** to make your selection.

 **MV/P 02 can only be used on **PRO** models**

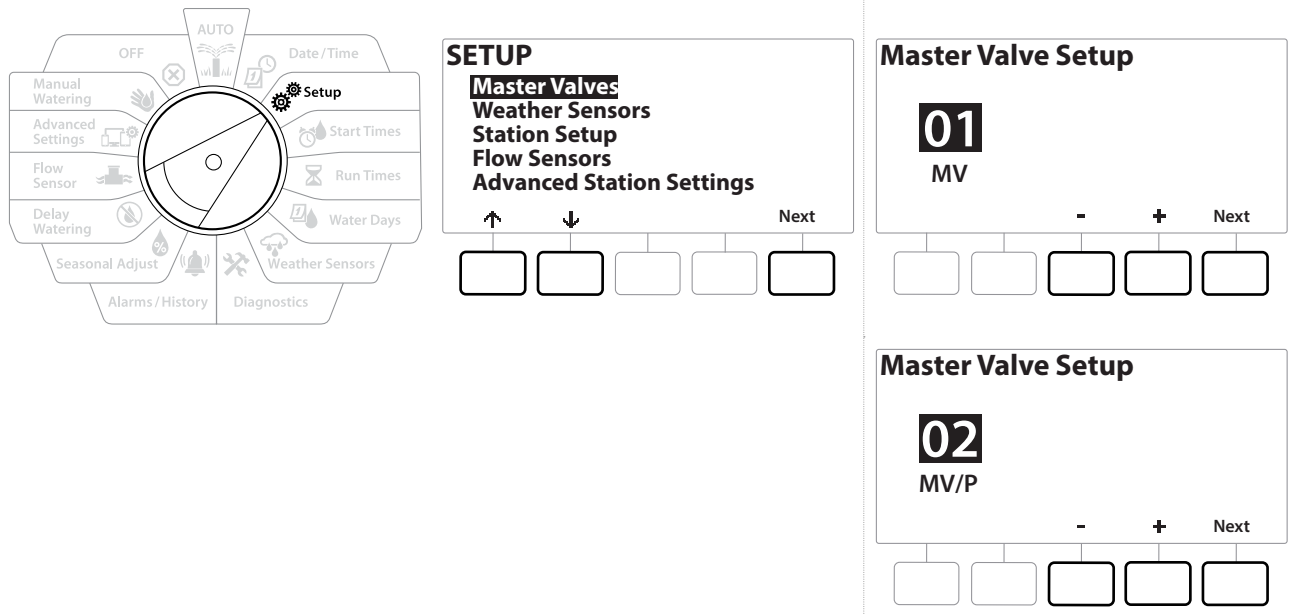

MV01 - (NCMV or NOMV Setup)

- 1 Use the **+** & **-** buttons to choose between a normally open (NOMV) or normally closed (NCMV) master valve to match your system configuration. Then press **Next**.

 *If your system does not have a master valve then select "Unused" and press Next.*

- 2 Select the number of valves that the MV will control (1 or 2).

 *Setting the number of valves to 2 will not control the valves individually, it will only adjust the output voltage to ensure both valves open.*

MV/P 02 - (Pump or NCMV Setup) - **PRO** Models Only

 MV/P 02 will not function independently. To use it you must have MV 01 set up.

- 1** If your system includes a pump set MV/P 02 to "Pump" using the + & - buttons from the Master Valves Setup screen, then press **Next** .

 If your system does not have a master valve then select "Unused" and press Next.

- 2** Select the number of pumps/ master valves that the MV/P 02 will control (1 or 2).

 Setting the number of pumps to 2 will not control them individually, it will only adjust the output voltage to ensure both valves open.

 MV02/P can also be used to set up a second Master valve (see [Configuration 3](#))

4.2 Weather Sensors

Weather Sensor Setup tells the LXME2 controller what types of weather sensors are used by your irrigation system.

Weather sensors are not required for the LXME2 controller, but they increase functionality by allowing irrigation control based on changing weather conditions. Follow the steps below if you have a local weather sensor installed in your system.

The LXME2 supports 1 local weather sensor connected to the base module (BCM or PSM).

Sensor Types	
Type	Action
Rain	Prevent
Freeze	Pause
Wind	Pause
Soil Moisture	Prevent
Custom Pause	Pause
Custom Prevent	Prevent

The diagram illustrates the navigation process. On the left, a circular dial is shown with 'Setup' selected. The 'SETUP' screen in the middle shows 'Weather Sensor' selected. The 'Weather Sensor Setup' screen on the right shows 'Custom Prevent' selected and a settling time of '00:30'.

- 1 Turn the controller dial to Setup
- 2 At the SETUP screen, with "Weather Sensors" selected, press **Next** .
- 3 At the Weather Sensor Setup screen, press the **+** and **-** keys to set the desired Sensor type.
- 4 Press the **button** to set the settling time. This defaults to 00:30 seconds but a custom settling time can be set using the **+** & **-** buttons.



Settling time is how long a weather condition must last before the controller takes action. For example, if a freeze sensor has a 5 minute settling time then the temperature would have to remain below the sensor's threshold set point for 5 minutes before irrigation is paused. Settling time can be set for immediate (0 seconds) or up to 10 minutes long.

- 5 When you have set up your weather sensor press the **Done** key.

4.3 Station Setup

Station Setup tells the LXME2 controller how many and what type of stations are used by your irrigation system.

 Before setting up stations, follow the previous instructions to set up [master valves](#) and [weather sensors](#) (if present).

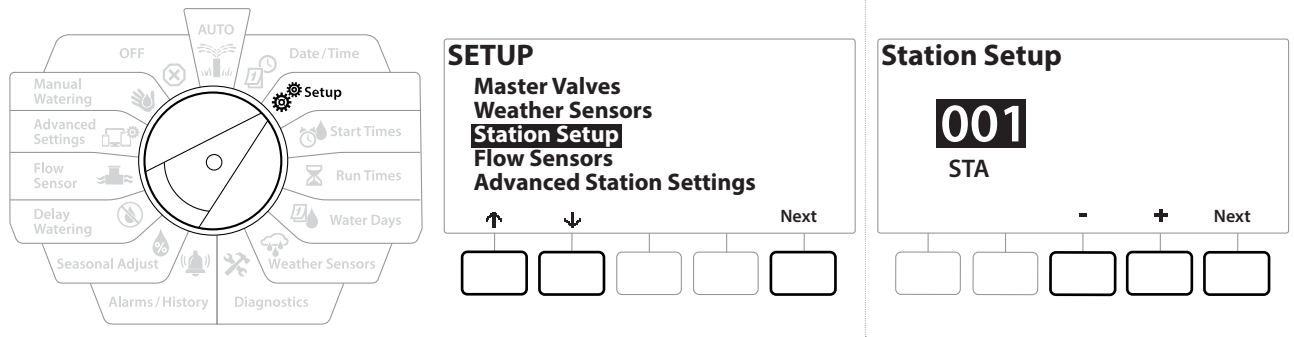

- 1 Turn the dial to Setup
- 2 At the SETUP screen, with "Station Setup" selected, press **Next** .
- 3 At the first Station Setup screen, press the **+** and **-** keys to set the Station you wish to setup 1-12 (up to 48 if expansion modules are installed).
- 4 With the desired station selected press **Next** .
- 5 The station you are setting up will be displayed at the top of the next screen. Use the **↑** and **↓** buttons to navigate the menu.

4.3.1 Station Priority

Station Priorities are only used when Station Sequencing is set to Sequence by Station Priority. If you are using the default Sequence by Station Numbers, then skip the next step by pressing "Next" (see "[Station Sequencing](#)" for more information).

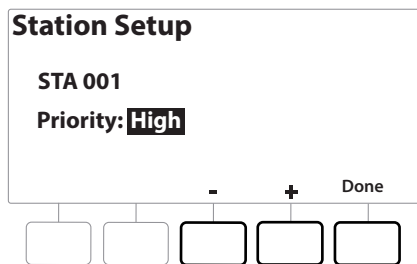
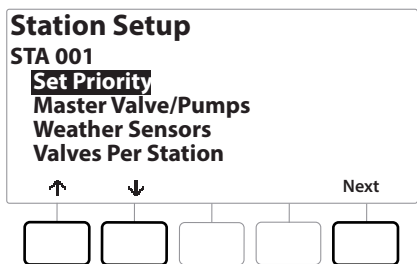
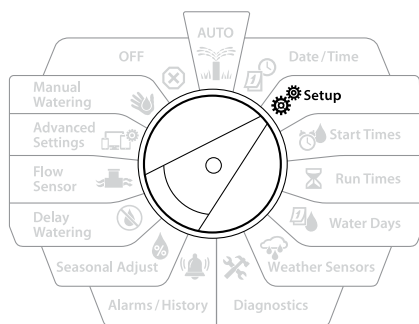

- 1 Select "Set Priority" and press the **Next** button.
- 2 Press the **+** and **-** keys to select the priority type. Each station can be set to High, Medium, Low or Non-irrigation (Non-Irrig).

Non-irrigation stations such as fountains and landscape lighting receive priority to always run, regardless of weather conditions.

4.3.2 Master Valves/ Pumps

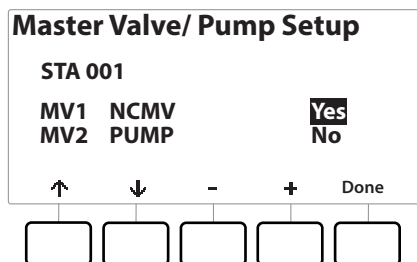
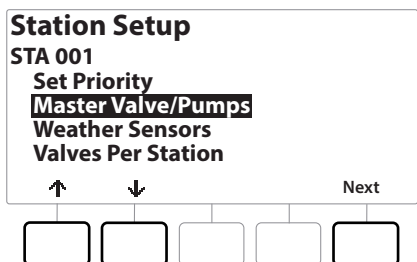
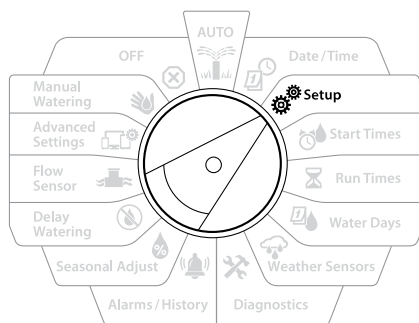

- 1 On the Second Station Setup screen navigate to Master Valves/ Pumps then press the **Next** button.
- 2 The Station you are setting up will be displayed at the top of the display. Use this screen to tell the controller if the Station is connected to a master valve. Use the **↑** and **↓** buttons to navigate between the **MV1** (master valve) and **MV2/P** (pump). Press the **+** & **-** buttons to select **Yes** (connected to MV) or **No** (not connected to MV).
- 3 Press the **Done** key to continue setting up the Station.

4.3.3 Weather Sensors

If you have a weather sensor connected to your system then follow the steps below to set it up in the controller.

Single Flow Sensor Installation Example

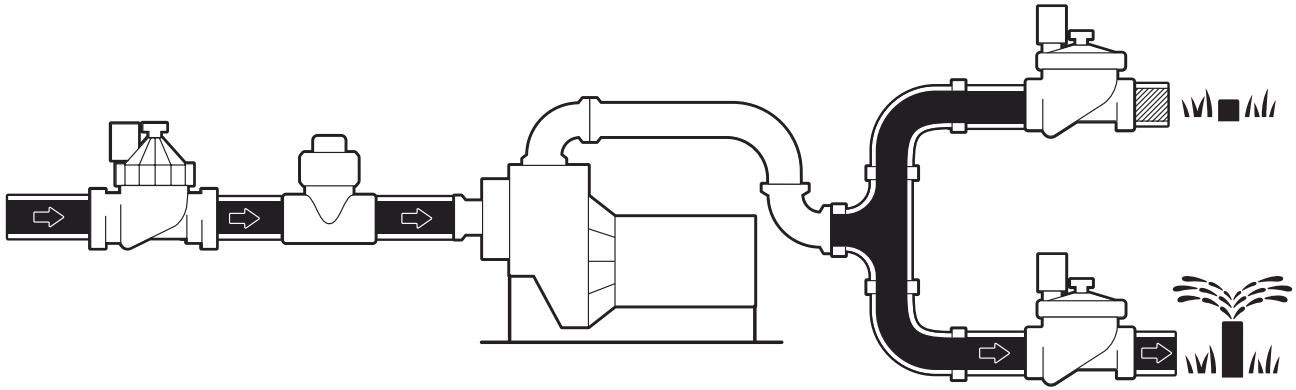

Dual Flow Sensor Installation Example

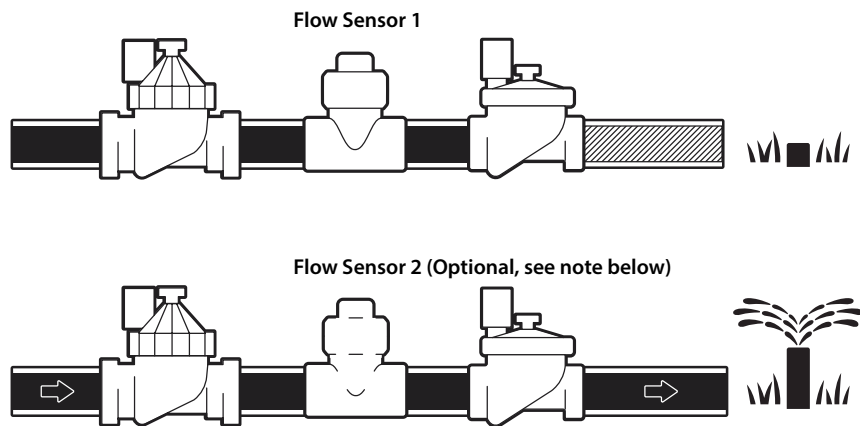

To measure flow from 2 water sources a device that scales the signals from two flow sensors and combines them into one digital output is needed. Use Combiflow CBF-100-00 or equivalent.

Setup a Rain Bird Flow Sensor

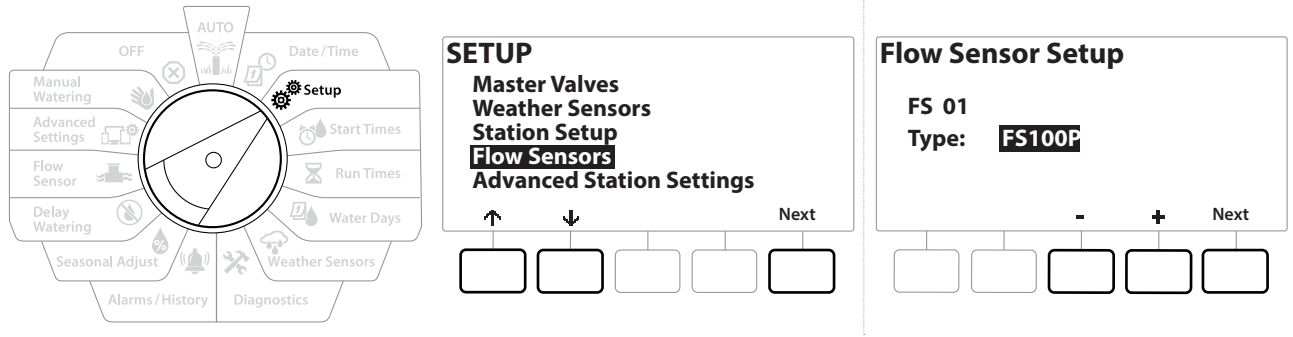

- 1 Turn the controller dial to Setup
- 2 On the SETUP screen, navigate to “Flow Sensors” using the up and down arrows, then press Next .
- 3 On the Flow Sensor Setup screen use the - & + buttons to select the flow sensor model that you are using, then press Next .

 If you are using a flow sensor that is not listed then select “Custom”

 The FS350B and FS350SS flow sensor types require the inside pipe diameter to be configured. Use the + & - buttons to set this and then the “Next” button to finish.

Setup a Third Party Flow Sensor (Custom)

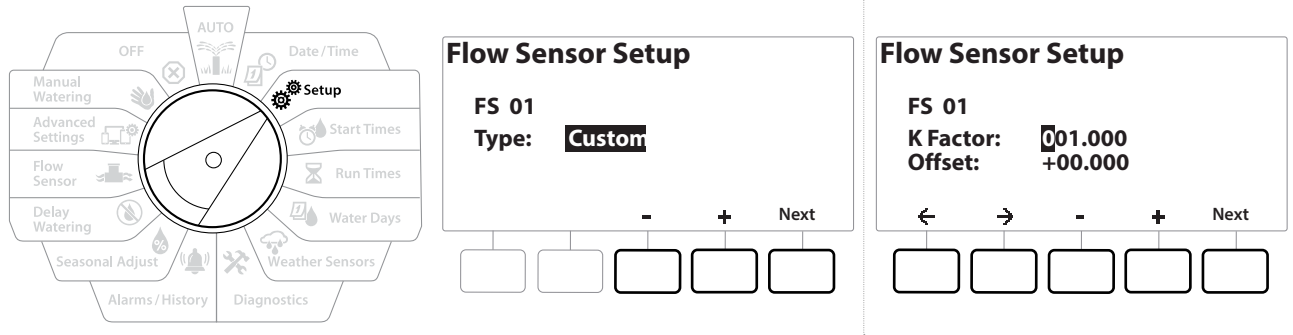

- 1 Turn the controller dial to Setup
- 2 On the SETUP screen, navigate to “Flow Sensors” using the up and down arrows, then press **Next** .
- 3 On the Flow Sensor Setup screen use the - & + buttons to navigate to “Custom”, then press **Next** .
- 4 Use the arrow buttons to navigate between number settings fields of the K Factor and Offset and use the + and - buttons to set the correct value.



Please refer to the instructions provided by the manufacturer of your flow sensor for the correct K Factor and Offset. These numbers must be correct in order to provide accurate flow information.

- 5 Press **Next** when the values on screen are set to the correct value.

4.4 Advanced Station Settings

4.4.1 Cycle + Soak (Advanced Station Settings)

The LXME2 controller Cycle+Soak feature allows water to be applied to stations intermittently. This can apply to any station and is useful for locations such as hillsides which can be difficult to irrigate effectively.

Cycle+Soak consists of two settings:

Cycle time: How long a station will run before soaking.

Soak time: How long irrigation is paused before applying another cycle.

For example, a station can be set up to receive 15 minutes of irrigation in three 5 minute cycles, with two 10 minutes periods of soak time in between waterings.

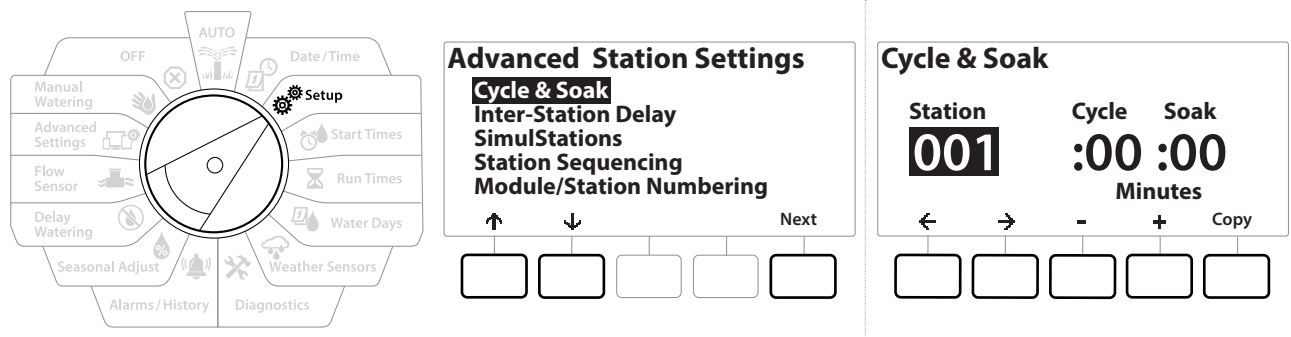

 Cycle+Soak™ settings apply to stations no matter which programs they may be used in.



- 1 Turn the controller dial to Setup
- 2 On the Setup screen to navigate to "Advanced Station Settings", then press Next .
- 3 With "Cycle & Soak" selected press Next .
- 4 Use the + and - buttons to set the Station that you wish to apply Cycle + Soak programming to.
- 5 Press the → button to navigate to Cycle time.
- 6 Press the + and - keys to set the Cycle time (between 1-60 minutes), then press the → button.

 Press and HOLD the + and - buttons to accelerate minute settings.

- 7 Press the + and - keys to set the Soak time (between 1-60 minutes).
- 8 To cancel Cycle+Soak on a station, set both Cycle and Soak to 0.

-  Consider using short Soak times, particularly if your watering schedule or Water Window is short. Long delay times could prevent scheduled irrigation from completing prior to the end of the Water Window.
-  The controller is designed to allow additional stations in the irrigation queue to run during the soak time for Cycle+Soak stations.
-  Repeat this process to set up Cycle+Soak on other stations, or copy this same programming to other stations by following the steps below.

4.4.2 Copy Station To Station

Use this time saving feature to copy the Cycle+Soak™ Programming from one station to other stations.

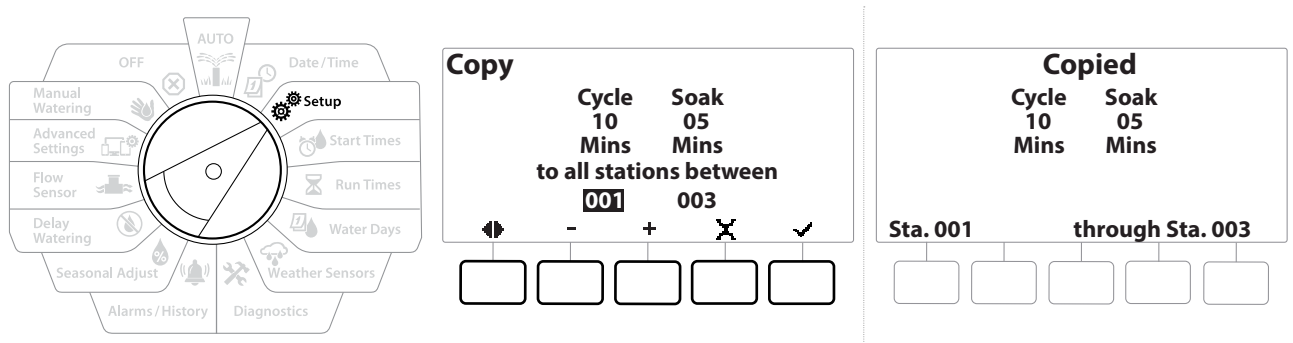

- 1 At the Cycle+Soak™ screen, press the “Copy” key.
- 2 At the Copy screen, use the ← & → buttons to navigate between the number setting fields. Press the + and - keys to set the desired starting and ending station numbers.
- 3 Press the ✓ key to copy the Cycle+Soak settings, or press the ✕ key to cancel copying.
- 4 A confirmation screen shows the process is complete.

4.4.3 Station Delay (Advanced Station Settings)

The LXME2 controller can be programmed to include a delay between stations.

For example, if you set a one minute delay, Station 1 will run until finished, followed by a one minute delay. Then station 2 will run, followed by another one minute delay, and so on.

4.4.6 Module/ Station Numbering (Advanced Station Settings)



When a new module is installed the Module/ Station Numbering screen will be displayed automatically. Making changes from the Setup dial position is not recommended at initial setup.

- 1 Turn the controller dial to Setup
- 2 Use the \downarrow key to navigate to “Advanced Station Settings”, on this screen, Use the \uparrow key to navigate to “Module/ Station Numbering”, then press **Next**. Press **Next** again on the dialog screen.

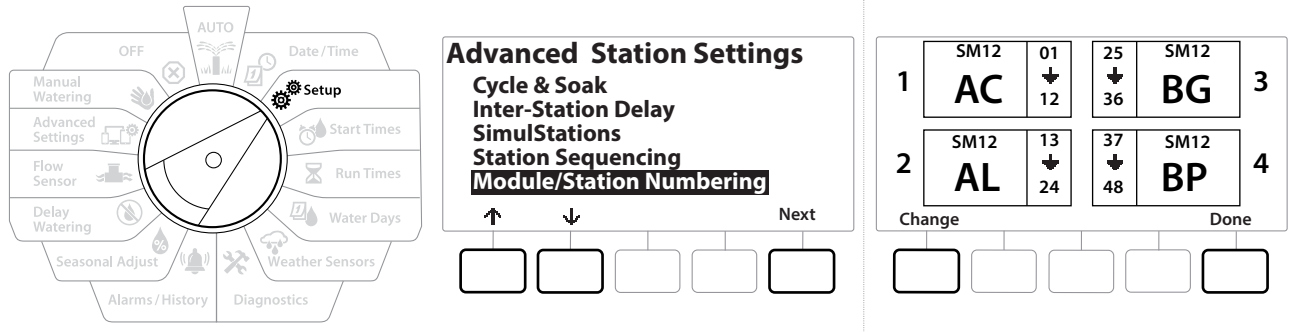

- 3 The Module Status screen appears. The current status of any installed station modules is displayed.
- 4 This screen can be used to change the labelling of the installed modules using the **Change** key.

5. SET START TIMES

Start times are the time(s) of day that a program begins.

You can assign up to 10 Start Times to a single program. Multiple Start Times allow you to run a program more than once on each day. For example, if you're growing new lawn seed, you may want to water several times a day to keep the seedbed or top dressing damp.

 *Start times apply to the entire program and not just to an individual station.*

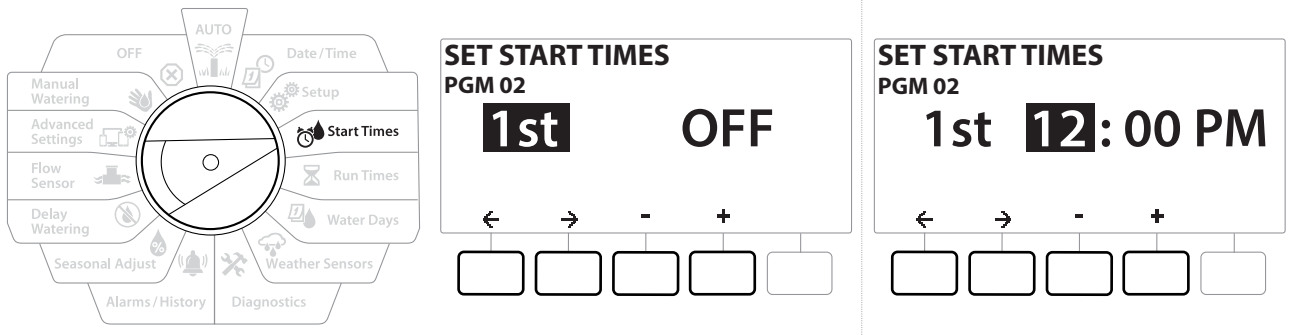

- 1 Turn the controller dial to Start Times
- 2 At the Set Start Times screen, press the **+** or **-** key to select the program you wish to create Start Times for.
- 3 Press the **+** and **-** keys to set the hour, then press the **→** key. Press the **+** and **-** keys to set the minutes.

 *If the desired program is not selected, press the [Program Select Button](#) to change it.*

- 4 Press the **←** and **→** keys to navigate between the number setting fields. Press the **+** and **-** keys to set additional Start Times (1 through 10).

 *Use the Program Select button and repeat this process to set up additional Watering Start Times for other programs as desired.*

 *Cycle+Soak™ is an alternative method of dividing the total Station Run Time into smaller cycle times. If you plan to use Cycle+Soak, only a single Watering Start Time is required for each program. See "[Cycle+Soak™](#)" for more details.*

6. ⌚ RUN TIMES

Run Times are the number of minutes (or hours and minutes) that each station runs.

Once your stations are set up, you can assign irrigation Run Times for each. Station Run Times are particular to programs, so typically stations are set for a single program.

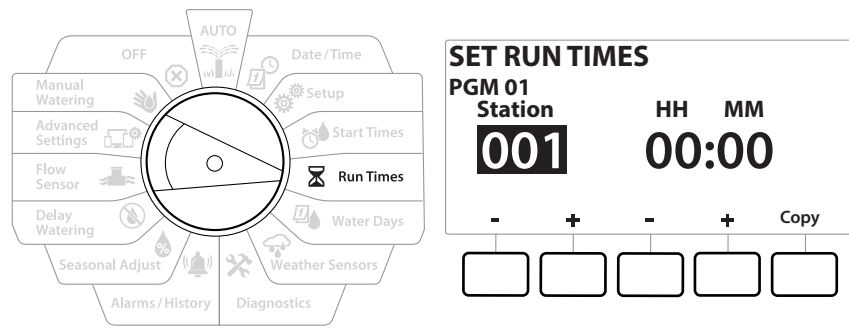

- 1 Turn the controller dial to Run Times
- 2 At the Set Run Times screen, press the first set of + and - keys to set the station to you wish to create programs for.

 If the desired program is not selected, press the [Program Select Button](#) to choose the desired program.

- 3 Press the second set of + and - keys to set the Station Run Time. Range can be from 00 hours, 00 minutes (no Run Time) up to 96:00 hours.

 Press and HOLD keys to accelerate settings.

 Use the [Program Select Button](#) to change the program and repeat this process to set up additional Station Run Times for other programs as desired.

6.4.1 Copy Run Times

You can copy Station Run Times from one program to other programs.

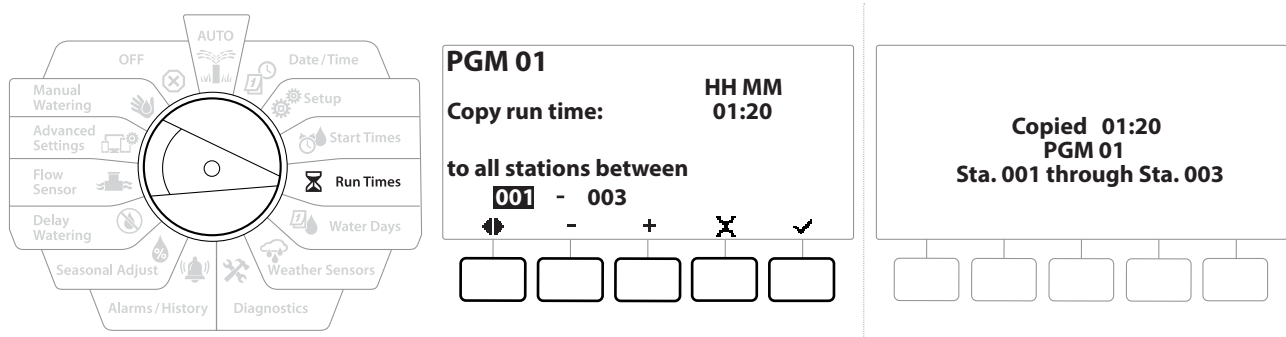

- 1 At the Set Run Times screen, press “Copy”.
- 2 At the Copy screen, use the ← & → key to navigate between the number setting fields. Press the + and - keys to set the desired starting and ending station numbers. Press the ✓ key to copy the station data, or press the ✕ key to cancel.
- 3 A confirmation screen shows the process is complete.

7. WATER DAYS

Watering Days are the specific days of the week on which irrigation is allowed to occur.

The LXME2 controller supports a variety of flexible watering day cycle options.

- **By Day of Week:** irrigation starts at chosen individual days in the week where program starts are allowed.
- **Cyclic days:** irrigation starts at regular chosen intervals such as every 3rd or 5th day, regardless of the calendar date.
- **Even Dates:** irrigation starts on all even numbered calendar days, such as the 2nd, 4th, 6th, etc.
- **Odd Dates:** irrigation starts on all odd numbered calendar days, such as the 1st, 3rd, 5th, etc.
- **Odd Dates no 31st:** irrigation starts on all odd numbered calendar days, such as the 1st, 3rd, 5th, etc., but not on the 31st.

 *Regardless of the Watering Cycle, irrigation will start only on days of the week where program starts are allowed.*

7.4.1 Custom, By Day of Week

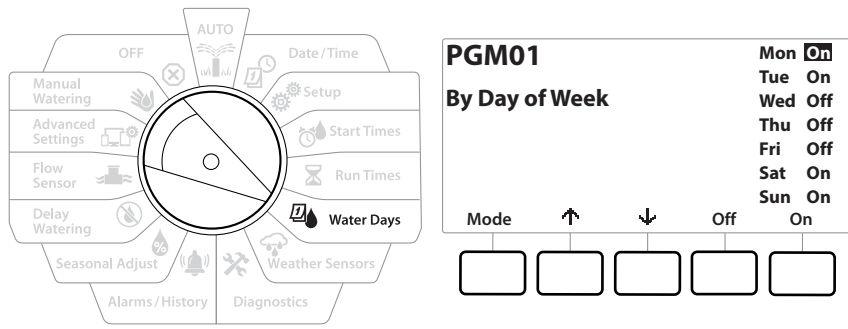

- 1 Turn the controller dial to Water Days
- 2 The Custom, By Day of Week screen appears.
- 3 Press the **On** key to allow irrigation on a given day of the week or else press **Off** to prevent from starting on that day.
- 4 Press the **↓** and **↑** keys to navigate through the days of the week.

7.4.2 Cyclic Days

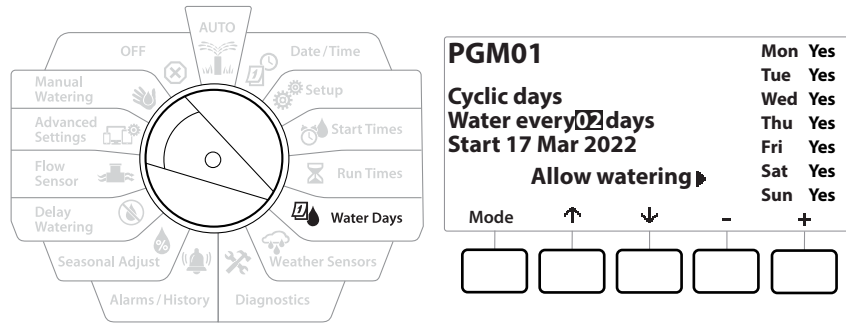

- 1 Turn the controller dial to Water Days
- 2 At the Watering Cycle screen, press the Mode key to navigate to the Cyclic Days screen.

 If the desired program is not selected, press the [Program Select Button](#) to choose the desired program.

- 3 At the Day Cycle screen, press the + and - key to set the watering day cycle (from 1 to 30 days). For example, set to the day cycle to 03 if you want to water every third day, then press the ↓ key.
- 4 Press the + and - keys to set the first date for the Watering Cycle to begin, then press the ↓ key.

 Press and HOLD keys to accelerate settings.

- 5 Press the Yes key to allow irrigation to start on a given day of the week or else press No to prevent irrigation from starting that day.
- 6 Press the ↓ and ↑ keys to navigate through the days of the week.

 Press the [Program Select Button](#) and repeat this process to select Cyclical Watering for other programs as desired.

7.4.3 Even days, Odd days, Odd no 31st

The process for setting up Even, Odd, and Odd no 31st Watering Cycles is very similar.

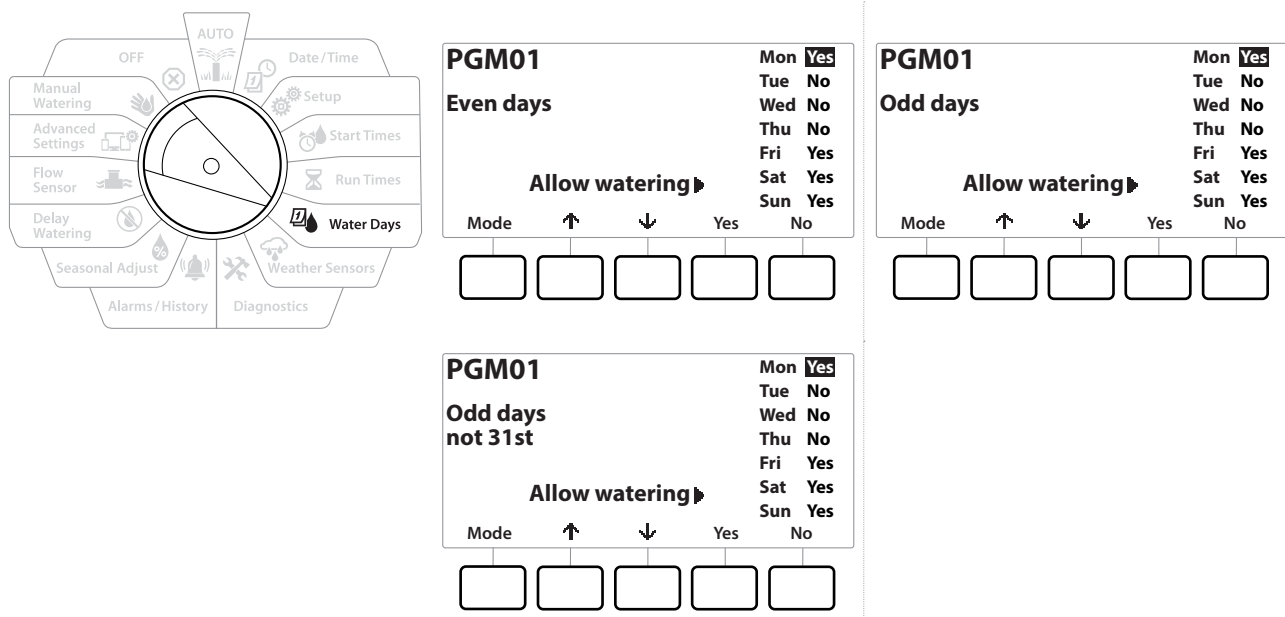

- 1 Turn the controller dial to Water Days
- 2 At the Watering Cycle screen, press the Mode key to navigate to the Even days, Odd days or Odd 31st screen.



If the desired program is not selected, press the Program Select button to choose the desired program. See "[Program Select Button](#)" for more details.

- 3 Press the **Yes** key to allow irrigation to start on a given day of the week or else press **No** to prevent irrigation from starting that day.
- 4 Press the **↓** and **↑** to navigate through the days of the week.

8. WEATHER SENSORS

The LXME2 can accept input from a single weather sensor wired directly to the controller.

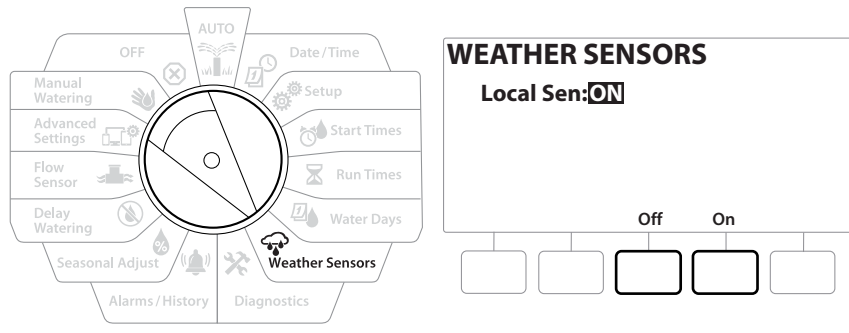

- 1 Turn the controller dial to Weather Sensors
- 2 At the Weather Sensors screen, press the On key to activate the local Weather Sensor or else press Off to bypass.

NOTICE

Follow the sensor manufacturer's instructions to correctly install and make wire connections to the sensor. Ensure the sensor installation is in compliance with all local codes.

Supported Rain Bird® Weather Sensors:

- **RSD** rain shut off device
- **WR2-RC** wireless rain sensor
- **WR2-RFC** wireless rain/freeze sensor

9. **DIAGNOSTICS**

9.4.1 **Test all Stations**

You can test all stations connected to the controller by running each of them in station number sequence.

This feature can be useful after installation, for general maintenance or as a first step in troubleshooting your system.

 *Only stations with programmed run times are included in the Test All Stations operation.*

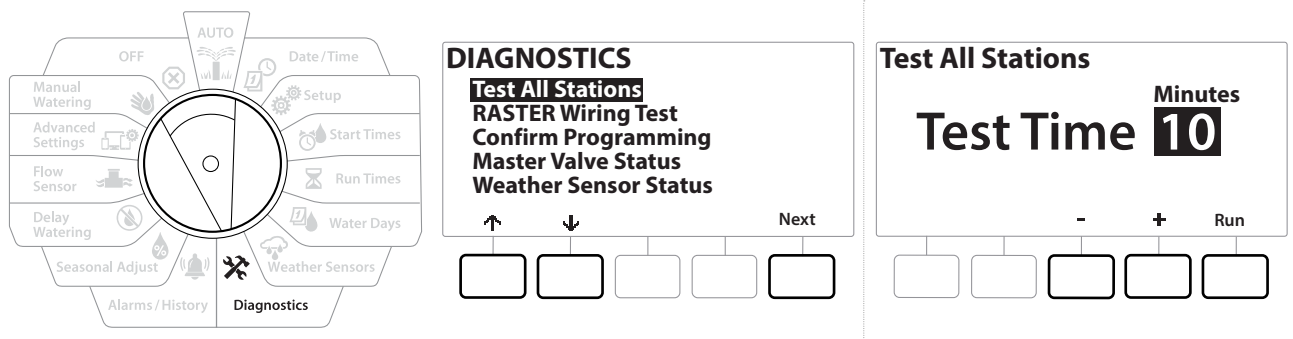

- 1 Turn the controller dial to Diagnostics
- 2 At the Diagnostics screen, with “Test All Stations” selected, press **Next**.
- 3 At the Test All Stations screen, press the **+** and **-** keys to set the desired time (from 1 to 10 minutes), then press “Run”.
- 4 A confirmation screen shows the test has started.

9.4.2 **Raster Wiring Test**

The ESP-LXME controller can quickly test to determine if any stations have shorted or if there are open wires or valve solenoids.

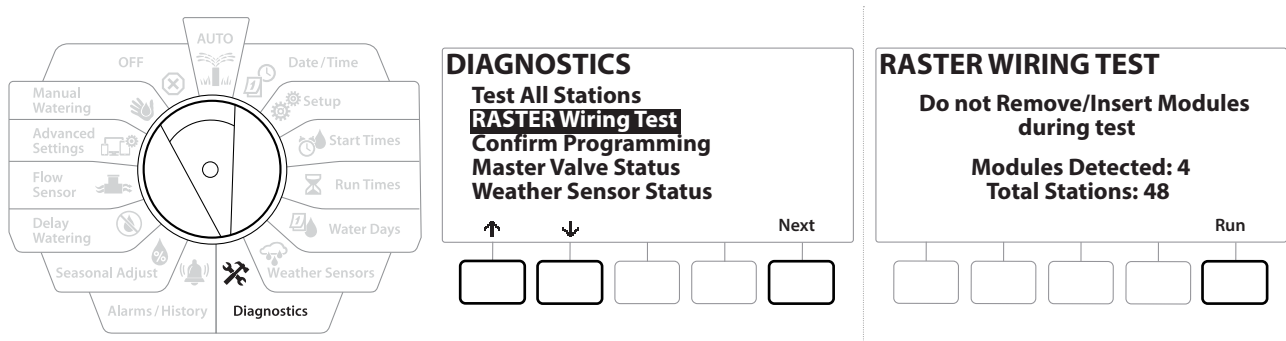

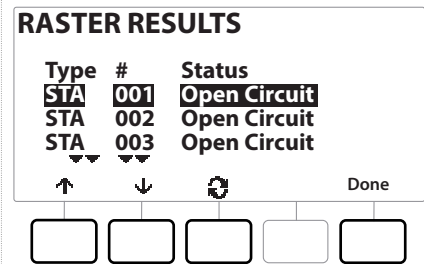
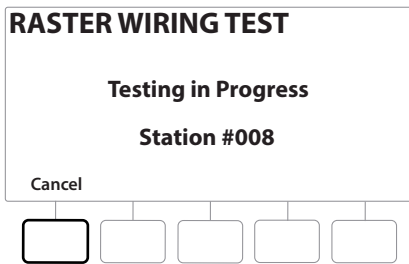
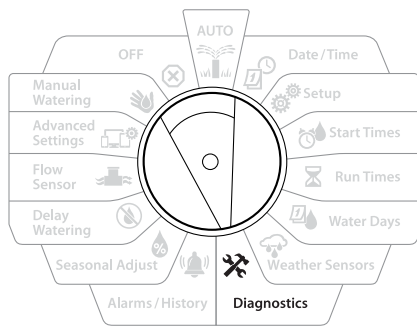

- 1 Turn the controller dial to Diagnostics
- 2 Use the ↑ & ↓ arrows to navigate to “RASTER Wiring Test”, press Next
- 3 The Raster Wiring Test screen will display there Modules Detected (this should be the number of wiring modules installed). And the total number of Stations.
- 4 Press the “Run” button to begin the wiring test.

The Raster Wiring Test will take up to a few minutes. Each installed station will be displayed on the screen in sequence as the controller tests them.

9.4.3 Confirm Programming

The LXME2 controller can make calculations and provide feedback on [Start Times](#) and total [Run Times](#) for programs and stations.

9.4.4 Program Summary

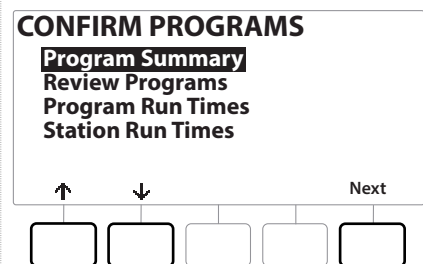
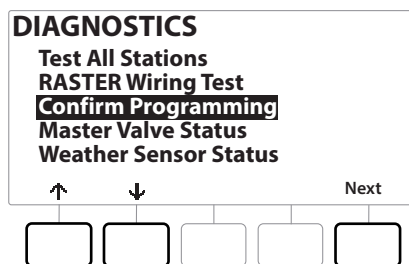
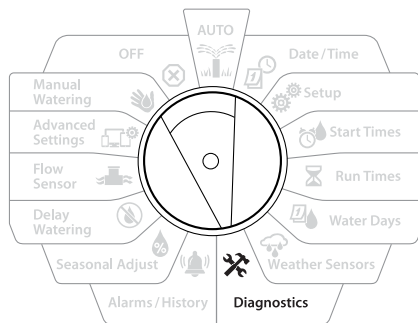

Program Summary			
PGM	Run Time	Run Time	Run Time
01	Y	Y	Y
02	Y	Y	Y
03	N	N	N

Done

- 1 Turn the controller dial to Diagnostics
- 2 At the DIAGNOSTICS screen, press the ↓ key to select “Confirm Programming”, then press Next .
- 3 At the CONFIRM PROGRAMS screen, with “Program Summary” selected, press Next .
- 4 The Program Summary screen appears, providing a summary of Run Times, Start Times and Water Days for all programs.

In the example above:

- Program 1 and 2 will run because they have Station Run Time, Start Time and Water Days all programmed, as indicated by the “Y” in each column.
- Program 3 will not run as it is missing all programming, as indicated by the “N” in each column.

9.4.5 Review Programs

Review program information for a station.

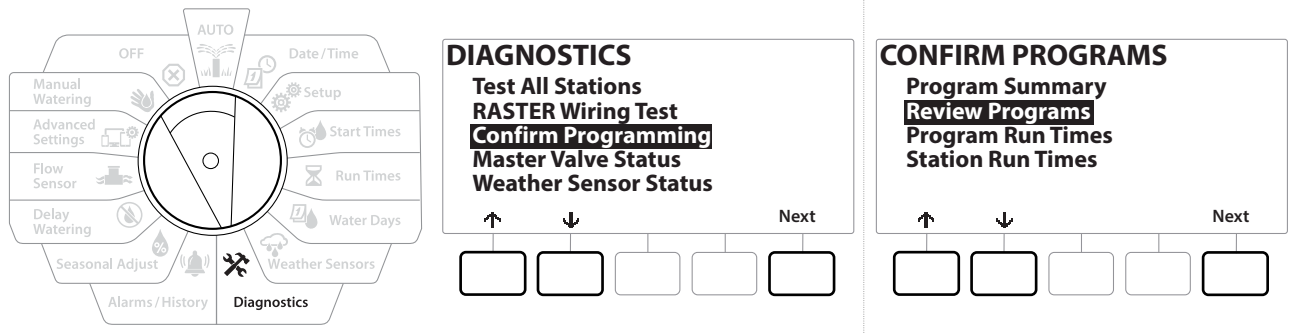

- 1 Turn the controller dial to Diagnostics
- 2 At the DIAGNOSTICS screen, press the ↓ key to select “Confirm Programming”, then press Next .
- 3 At the CONFIRM PROGRAMS screen, press the ↓ key to select “Review Programs”, then press Next .
- 4 The following screens provide a complete summary of the LXME2’s programming. Pressing the Next button will allow you to progress from screen to screen, while pressing the Back button take you back to the previous screen. Some of the screens will allow you to make programming changes directly using the programming buttons.

1	Program Summary	<p>PGM 01 Watering Start Times</p> <table border="0"> <tr><td>1</td><td>01:00</td><td>6</td><td>OFF</td></tr> <tr><td>2</td><td>02:00</td><td>7</td><td>OFF</td></tr> <tr><td>3</td><td>03:00</td><td>8</td><td>OFF</td></tr> <tr><td>4</td><td>04:00</td><td>9</td><td>OFF</td></tr> <tr><td>5</td><td>05:00</td><td>10</td><td>OFF</td></tr> </table> <p>Next</p>	1	01:00	6	OFF	2	02:00	7	OFF	3	03:00	8	OFF	4	04:00	9	OFF	5	05:00	10	OFF	2	Water Days	<p>PGM 01 Water Days Cyclic</p> <table border="0"> <tr><td>Mo</td><td>Tu</td><td>We</td><td>Th</td><td>Fr</td><td>Sa</td><td>Su</td></tr> <tr><td>✓</td><td>✓</td><td>✓</td><td>✓</td><td>✗</td><td>✗</td><td>✗</td></tr> </table> <p>Next</p>	Mo	Tu	We	Th	Fr	Sa	Su	✓	✓	✓	✓	✗	✗	✗
1	01:00	6	OFF																																				
2	02:00	7	OFF																																				
3	03:00	8	OFF																																				
4	04:00	9	OFF																																				
5	05:00	10	OFF																																				
Mo	Tu	We	Th	Fr	Sa	Su																																	
✓	✓	✓	✓	✗	✗	✗																																	
3	Run times	<p>PGM 01 Run Times HH:MM</p> <table border="0"> <tr><td>STA</td><td></td></tr> <tr><td>001</td><td>01:20</td></tr> <tr><td>002</td><td>00:30</td></tr> <tr><td>003</td><td>00:15</td></tr> </table> <p>Next</p>	STA		001	01:20	002	00:30	003	00:15	4	Seasonal Adjust	<p>PGM 01 Seasonal Adjust 100%</p> <p>Next</p>																										
STA																																							
001	01:20																																						
002	00:30																																						
003	00:15																																						
5	Seasonal Adjust By Month	<p>PGM 01 Seasonal Adjust by Month Not used by PGM01</p> <p>Next</p>	6	Rain Delay	<p>Rain Delay Irrigation will run after selected date</p> <p>From: --- To: ---</p> <p>Next</p>																																		

7	Calendar Day Off	<p>Calendar Day Off</p> <p>No Calendar Days Off</p> <p>Next</p> <p><input type="text"/> <input type="text"/> <input type="text"/> <input type="text"/> <input type="text"/></p>	8	Station Delay	<p>PGM01</p> <p>Station Delay</p> <p>Delay Between Stations</p> <p>03:10</p> <p>MM:SS</p> <p>Next</p> <p><input type="text"/> <input type="text"/> <input type="text"/> <input type="text"/> <input type="text"/></p>																																
9	Cycle+Soak Minutes	<p>Cycle+Soak Minutes</p> <table border="1"> <thead> <tr> <th>STA</th> <th>Cycle</th> <th>Soak</th> </tr> </thead> <tbody> <tr> <td>001</td> <td>10</td> <td>05</td> </tr> <tr> <td>002</td> <td>10</td> <td>05</td> </tr> <tr> <td>003</td> <td>10</td> <td>05</td> </tr> </tbody> </table> <p>Next</p> <p><input type="text"/> <input type="text"/> <input type="text"/> <input type="text"/> <input type="text"/></p>	STA	Cycle	Soak	001	10	05	002	10	05	003	10	05	10	MV Assignment	<p>MV Assignment</p> <table border="1"> <thead> <tr> <th>STA</th> <th>FZ</th> <th>MV1</th> <th>2</th> </tr> </thead> <tbody> <tr> <td>001</td> <td>-</td> <td>N</td> <td>N</td> </tr> <tr> <td>002</td> <td>1</td> <td>Y</td> <td>N</td> </tr> <tr> <td>003</td> <td>1</td> <td>Y</td> <td>N</td> </tr> <tr> <td>004</td> <td>1</td> <td>Y</td> <td>N</td> </tr> </tbody> </table> <p>Next</p> <p><input type="text"/> <input type="text"/> <input type="text"/> <input type="text"/> <input type="text"/></p>	STA	FZ	MV1	2	001	-	N	N	002	1	Y	N	003	1	Y	N	004	1	Y	N
STA	Cycle	Soak																																			
001	10	05																																			
002	10	05																																			
003	10	05																																			
STA	FZ	MV1	2																																		
001	-	N	N																																		
002	1	Y	N																																		
003	1	Y	N																																		
004	1	Y	N																																		
11	Weather Sensor Assignment	<p>MV Assignment</p> <table border="1"> <thead> <tr> <th>STA</th> <th>Loc</th> </tr> </thead> <tbody> <tr> <td>001</td> <td>N</td> </tr> <tr> <td>002</td> <td>Y</td> </tr> <tr> <td>003</td> <td>Y</td> </tr> <tr> <td>004</td> <td>Y</td> </tr> </tbody> </table> <p>Next</p> <p><input type="text"/> <input type="text"/> <input type="text"/> <input type="text"/> <input type="text"/></p>	STA	Loc	001	N	002	Y	003	Y	004	Y	12	Water Window	<p>PGM 01</p> <p>Water Window</p> <p>Open: OFF</p> <p>Closed: OFF</p> <p>Duration: N/A</p> <p>HH:MM</p> <p>Next</p> <p><input type="text"/> <input type="text"/> <input type="text"/> <input type="text"/> <input type="text"/></p>																						
STA	Loc																																				
001	N																																				
002	Y																																				
003	Y																																				
004	Y																																				
13	Program SimulStations	<p>PGM 01</p> <p>Program SimulStations</p> <p>Maximum Number of SimulStations</p> <p>Irrigation 5</p> <p>Next</p> <p><input type="text"/> <input type="text"/> <input type="text"/> <input type="text"/> <input type="text"/></p>	14	Controller SimulStations	<p>Controller SimulStations</p> <p>Maximum Number of SimulStations</p> <p>Irrigation 1</p> <p>Non-Irrigation 1</p> <p>Next</p> <p><input type="text"/> <input type="text"/> <input type="text"/> <input type="text"/> <input type="text"/></p>																																
15	Contractor Default Delayed Recall	<p>Backup</p> <p>Controller Default Backup Not Stored</p> <p>Next</p> <p><input type="text"/> <input type="text"/> <input type="text"/> <input type="text"/> <input type="text"/></p>																																			



If the desired program is not selected, press the Program Select button to choose the desired program. See "[Program Select Button](#)" for more details.

9.4.6 Program Run Times

Review total Run Time for an individual program.

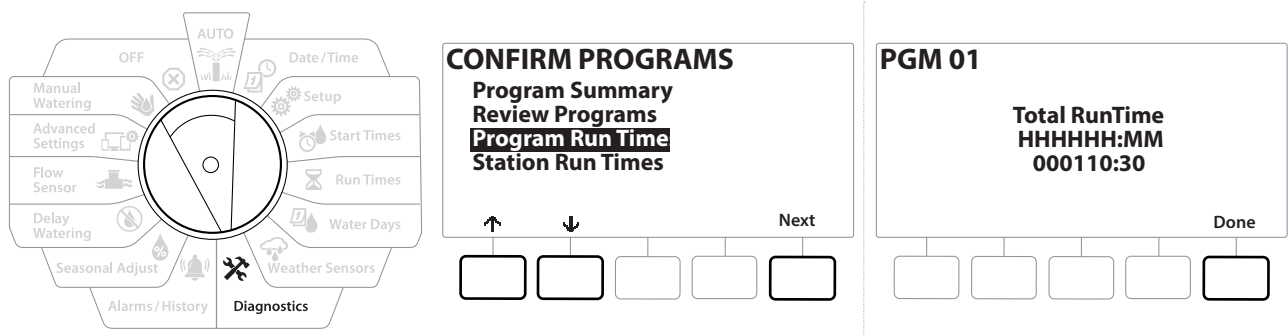

- 1 Turn the controller dial to Diagnostics
- 2 At the DIAGNOSTICS screen, press the ↓ key to select “Confirm Programming”, then press Next .
- 3 At the CONFIRM PROGRAMS screen, press the ↓ key to select “Program Run Times”, then press Next .
- 4 The Total Run Time screen appears and total Run Time is shown for the currently selected program.

 If the desired program is not selected, press the Program Select button to choose the desired program. See [“Program Select Button”](#) for more details.

 For stations set up for Cycle+Soak, the Cycle Time (when irrigation is occurring) will be included in Program RunTime calculations but Soak times will NOT be included. See [“Cycle+Soak™”](#) for more details.

 Use the Program Select button to change the program and repeat this process to review and confirm Program Run Times for other programs as desired.

9.4.7 Station Run Times

Review total Run Time for all stations.

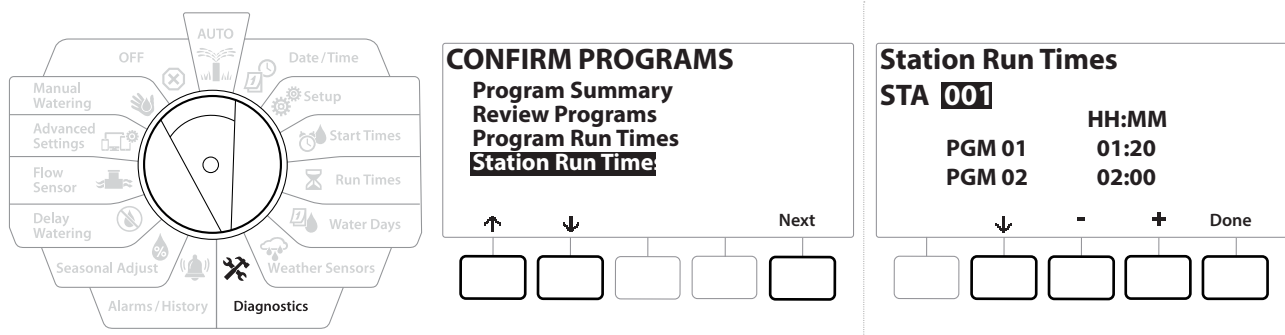

- 1 Turn the controller dial to Diagnostics
- 2 At the DIAGNOSTICS screen, press the ↓ key to select “Confirm Programming”, then press Next .
- 3 At the CONFIRM PROGRAMS screen, press the ↓ key to select “Station Run Times”, then press Next .
- 4 At the Station Run Time screen, press the + and - keys to select the desired Station. Station Run Times are shown for the currently selected station in all programs.
- 5 Press the ↓ and ↑ to scroll the list of programs. For Stations where a particular Program is not used then no run time is shown.

 To make changes make Run Time changes see [“Run Times”](#).

 Soak times for stations set up with Cycle+Soak are not included in the Station Run Time calculations. See [“Cycle+Soak™”](#) for more details.

9.4.8 Master Valve Status

Review status of Master Valves.

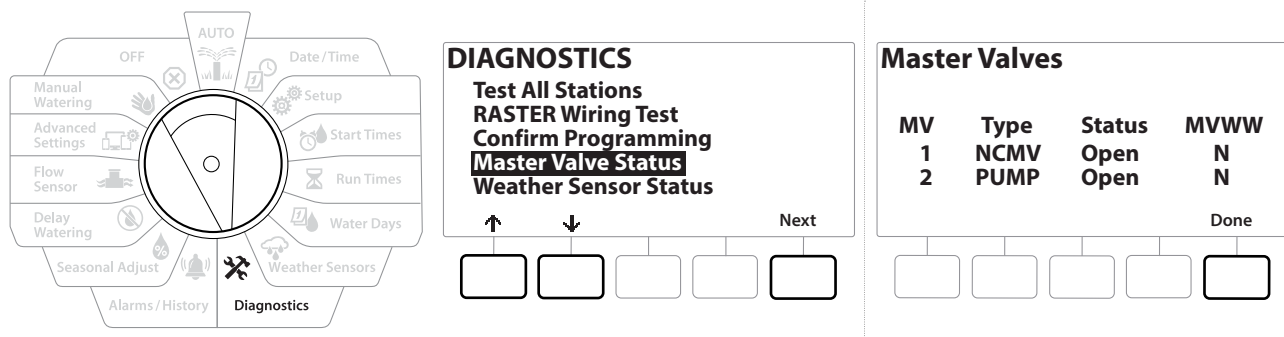

- 1 Turn the controller dial to Diagnostics
- 2 At the DIAGNOSTICS screen, press the ↓ key to select “Confirm Programming”, then press Next .
- 3 At the CONFIRM PROGRAMS screen, press the ↓ key to select “Review Master Valves”, then press Next .
- 4 The Master Valves screen appears, showing installed master valves, their type (Normally Closed or Normally Open), their current status (open or closed) and if they are included in the MV Water Window (MVWW) (Yes or No).

9.4.9 Weather Sensor Status

- 1 Turn the controller dial to Diagnostics
- 2 At the DIAGNOSTICS screen, press the ↓ key to select “Confirm Programming”, then press Next .
- 3 At the CONFIRM PROGRAMS screen, press the ↓ key to select “Weather Sensor Status”, then press Next .
- 4 The Weather Sensor Status screen displays the current status of the local weather sensor as either On or Off.

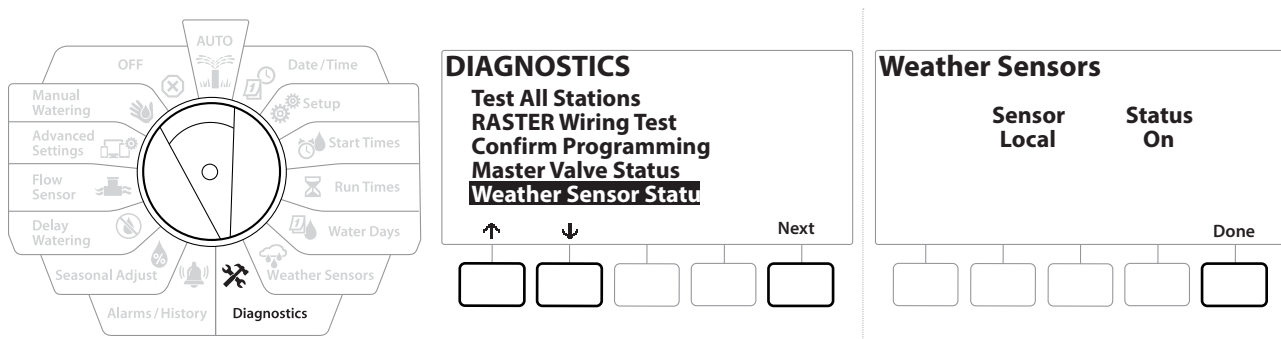

10. ALARMS/HISTORY

10.4.1 Flow History

With **Flo-Watch™** enabled, the controller will automatically track the volume of water flowing through the system.

 This can be useful for checking your actual water consumption against your water bill.

- 1 Turn the controller dial to Alarms/History
- 2 At the ALARMS AND HISTORY screen, with “Flow History” selected, press **Next**.
- 3 The Flow History screen appears, showing month-to-date and last month water consumption.

 Press the **Days** key to change the view to the last 30 days and previous 30 days.

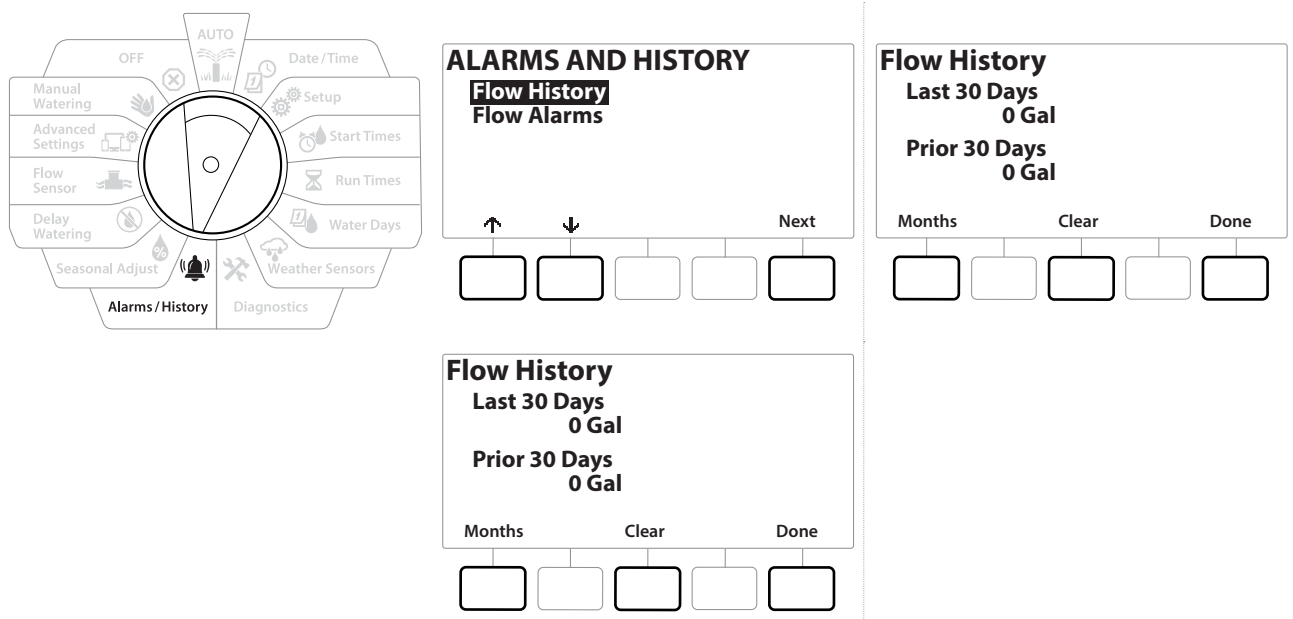

10.4.2 Clear Flow History

- 1 At the Clear Flow History confirmation screen, press the **Yes** key to continue. If you're not sure, press the **No** key.
- 2 The confirmation screen appears, showing that Flow History has been cleared, resetting the flow to 0.

 Pressing **Clear** from either the monthly or daily screen will clear BOTH monthly and daily flow log data.

FloZone Flow Alarms

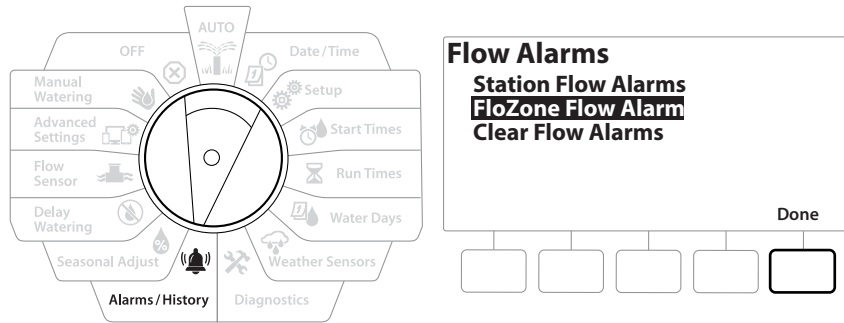

- 1 Turn the controller dial to Alarms/History
- 2 At the ALARMS AND HISTORY screen, press the ↓ key to select “Flow Alarms”, then press Next .
- 3 At the Flow Alarms screen, press the ↓ key to select “FloZone Flow Alarms”, then press Next .
- 4 At the FloZone Alarms screen, press the + and - keys to view other FloZone flow alarms.

Clear Flow Alarms

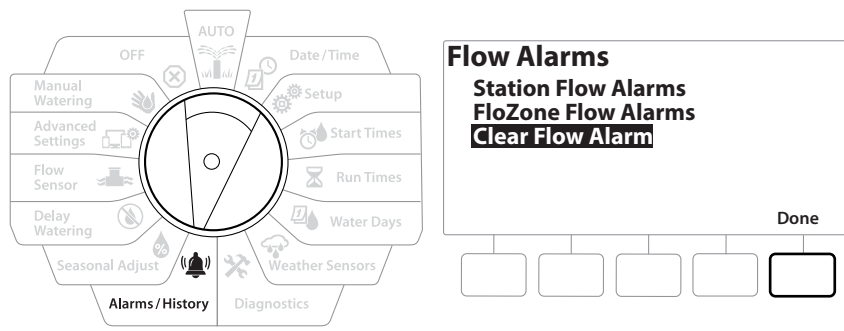

- 1 Turn the controller dial to Alarms/History
- 2 At the ALARMS AND HISTORY screen, press the ↓ key to select “Flow Alarms”, then press Next .
- 3 At the Flow Alarms screen, press the ↓ key to select “Clear Flow Alarms”, then press Next .
- 4 The Clear All Flow Alarms screen appears. Press Yes to clear all Station and FloZone Flow Alarms.
- 5 A confirmation screen shows that Flow Alarms have been cleared.

11. **SEASONAL ADJUST**

Seasonal Adjust allows you to use the heaviest irrigation season as a baseline so that lesser amounts of watering occur during those seasons.

For example, you could set July at 100% and set October to 50% so there would be half as much watering in Fall than in Summer. Seasonal adjustments can be managed by month or by program.

NOTICE

Multiple Seasonal Adjustment settings affect each other and can significantly impact irrigation. For example, if you set a program-level Seasonal Adjustment of 10% and then a monthly Seasonal Adjustment of 10% then irrigation will be reduced to 1% of normal (10% of 10%). Consider using only one type of Seasonal Adjustment setting.

Setting a small number for the Seasonal Adjustment percentage will greatly reduce watering and setting to 0% will cancel irrigation entirely. Use caution when making Seasonal Adjustment settings.

11.4.1 Individual Program

Seasonal Adjust can be set to adjust by individual program.

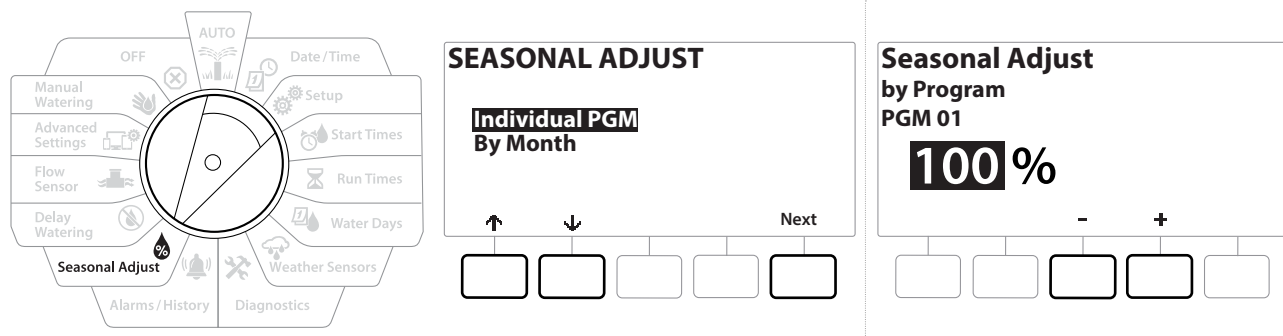

- 1 Turn the controller dial to Seasonal Adjust.
- 2 At the SEASONAL ADJUST screen, with "Individual Program" selected, press **Next**.
- 3 Press the **+** and **-** keys to set the seasonal adjustment percentage (from 0 - 300%).

 Press and **HOLD** keys to accelerate settings.

 If the desired program is not selected, press the Program Select button to choose the desired program. See "[Program Select Button](#)" for more details.

11.4.2 By Month

% Adjust

Seasonal Adjust can be set to adjust by the specific month.

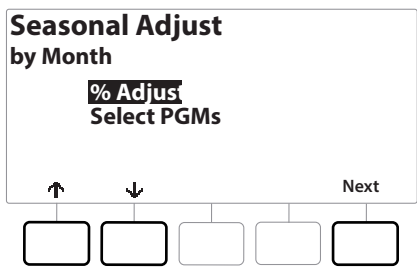
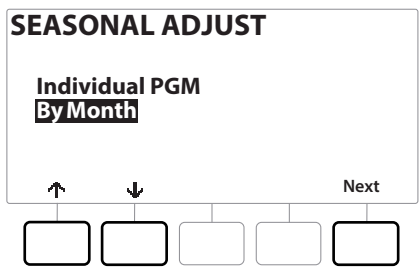
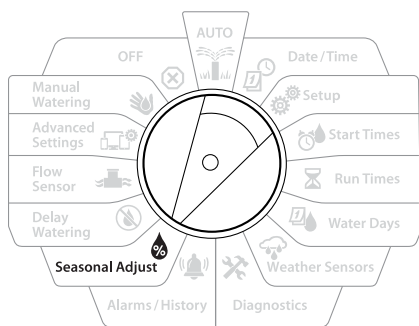

- 1 Turn the controller dial to Seasonal Adjust
- 2 At the SEASONAL ADJUST screen, press the  key to select "By Month," then press Next .
- 3 At the Seasonal Adjust by Month screen, with "% Adjust" selected, press Next .

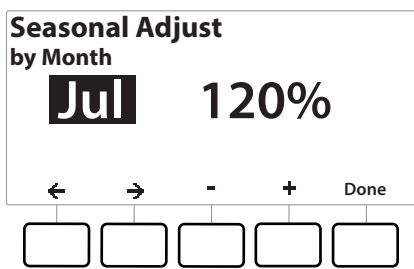
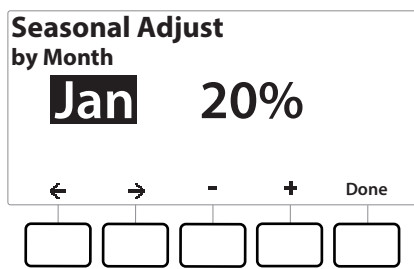

- 4 Press the + and - keys to select the month you would like to adjust.
- 5 Press  to select the percentage field. Then press the + and - keys to set the percentage (from 0 - 300%).

 Press and HOLD keys to accelerate settings.

 Repeat this process to set Seasonal Adjustments for other months as desired. Use the Program Select button to change the program and repeat this process to set Seasonal Adjustments By Month for other programs as desired.

 The % Adjust will automatically change to the new month's percentage setting on the first day of the month.

Select Programs

Seasonal Adjust can be set to adjust by program for specific months.

- 1 Turn the controller dial to Seasonal Adjust
- 2 At the SEASONAL ADJUST screen, press the ↓ key to select “By Month”, then press Next .
- 3 At the Seasonal Adjust by Month screen, press the ↓ key to choose “Select PGMs”, then press Next .
- 4 Press the Yes or No keys to set Monthly Adjust for the current selected program.

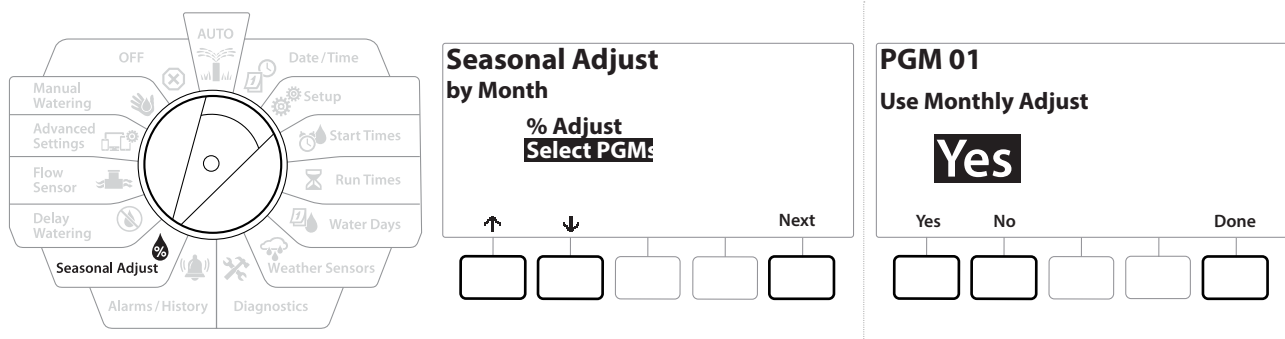

 If the desired program is not selected, press the Program Select button to choose the desired program. See [“Program Select Button”](#) for more details.

 Repeat this process to set Monthly Adjustments for other programs as desired.

12. **DELAY WATERING**

12.4.1 **Rain Delay**

The LXME2 controller's Rain Delay feature lets you discontinue irrigation for a few days after a period of heavy rain.

 *If you have a rain sensor attached to the controller, it may be unnecessary to manually program a Rain Delay. Consult the rain sensor device documentation for more details.*

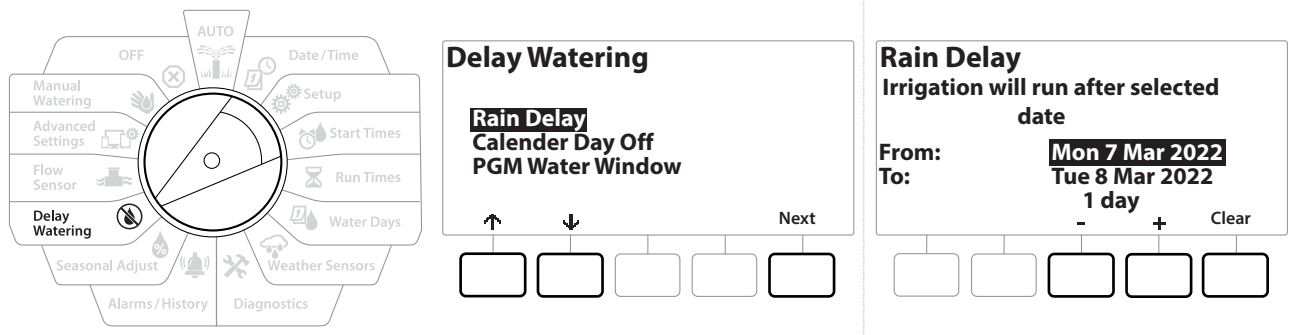

- 1 Turn the controller dial to Delay Watering
- 2 At the Delay Watering screen, with Rain Delay selected, press **Next** .
- 3 At the Rain Delay screen, press the **+** and **-** keys to set the number of days (from 0 to 30 days). Press the **Clear** key if you want to cancel the Rain Delay.

 *Confirmation of Rain Delay will display in the AUTO dial position.*

 *The next irrigation date after the Rain Delay calculates and shows automatically.*

 *A Rain Delay affects all programs, but stations set up as Non-irrigation will still run during a Rain Delay.*

12.4.2 **Calendar Day Off**

The LXME2 controller can be programmed to suspend irrigation on a particular calendar date, for up to 15 days of the year.

You can schedule certain days of the year as Non-irrigation, such as holidays when landscape may receive heavy use.

 *Calendar Day Off dates can only be selected 365 days in advance. Then once a Calendar Day Off has passed, it will be removed from the list and must be reprogrammed for the following year if desired.*

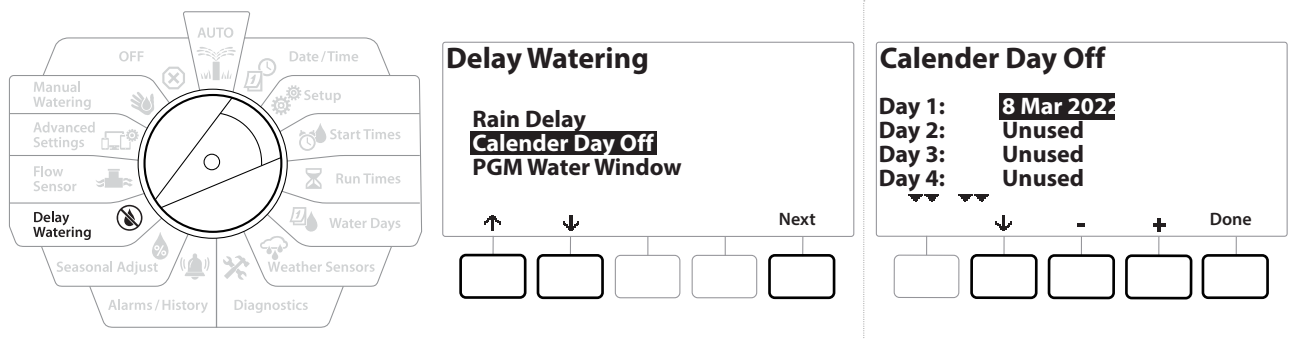

- 1 Turn the controller dial to Delay Watering
- 2 At the Delay Watering screen, press the ↓ key to select “Calendar Day Off”, then press Next .
- 3 The Calendar Day off screen appears, showing (up to 5) scheduled calendar days off in chronological order. Unprogrammed days will show as Unused.
- 4 Press the + and - keys to set the Calendar Day Off date as desired.
- 5 Press the ↑ & ↓ buttons to set other days as desired.

 Press and HOLD keys to accelerate settings.

 Calendar Day Off affects ALL programs and stations, including non-irrigation stations. Consider not using this feature if any of your programs include essential functions such as door locks or sports field lighting.

12.4.3 Program Water Window

You can specify certain times of the day/night when irrigation is allowed.

Watering is not allowed outside these “Water Windows”. This is helpful to comply with local regulations which may prohibit irrigation during certain hours.

NOTICE

Be sure a Water Window is sufficient to allow irrigation programs to run completely. Irrigation scheduled outside the Water Window will be paused and will resume when the Water Window opens again. This can cause irrigation programs to “stack” and eventually create an alarm condition if the controller stacks 8 or more programs.

 Water windows can be scheduled to cross midnight. For example, a Water Window can start at 10:00 PM and continue until 4:00 AM the next morning. Be sure your Watering Start Times are set to occur within the Water Window. See “[Set Start Times](#)” for more details.

12.4.4 Water Window Set Up

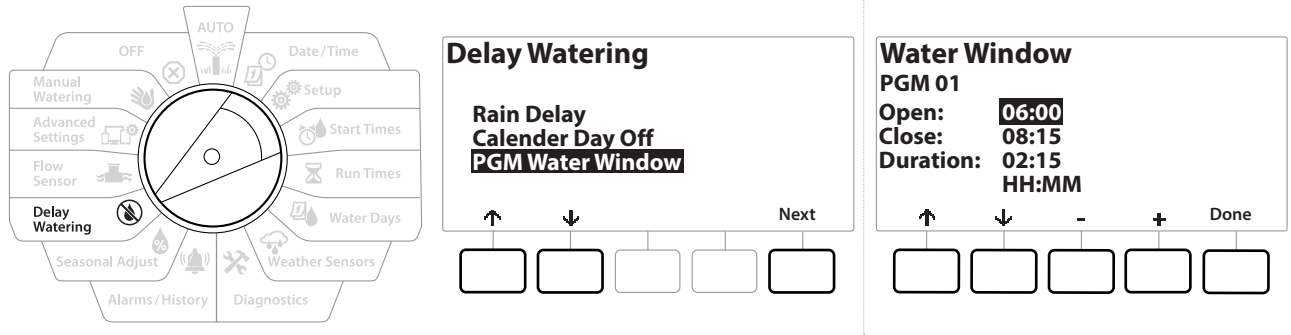

- 1 Turn the controller dial to Delay Watering
- 2 At the Delay Watering screen, press the ↓ key to select “PGM Water Window”, then press Next .
- 3 At the Water Window screen, press the + and - keys to set the time when the Watering Window opens, then press the ↓ key.

 Press and HOLD keys to accelerate settings.

- 4 Press the + and - keys to set the time when the Watering Window closes. As you adjust the close time, the duration of your Water Window calculates automatically.

 To clear a previously set Water Window, press the + and - keys to set both the Open and Close times to OFF (between 11:59 and 12:00 AM).

 Use the Program Select button to set the Water Window for another program, if desired.

13. FLOW SENSOR

13.4.1 Introduction to Flow

The LXME2 controller offers a wide variety of flow-related functionality to utilize your system more efficiently, with or without additional flow sensing hardware.

 [See here for examples of flow sensor installations.](#)

13.4.2 FloZones Overview

The FloZone is the group of stations connected to the Master Valve. The LXME2 supports 1 FloZone. Non Irrigation Stations are not part of the FloZone.

13.4.3 Flow Management Features

After setting the [Master Valves](#) and FloZones for your system, the next step is to decide which flow-related features you'd like to use.

The LXME2 controller flow features can be divided into two different functional groups; Flo-Manager® and FloWatch.

Flo-Manager®

Flo-Manager® adds basic hydraulic management features to your system to ensure that sufficient water pressure and volume is available to operate all stations.

 *Although it is helpful, flow sensing hardware is not required to use Flo-Manager®. You can manually enter estimated flow rates even if flow sensing hardware is not installed.*

Flo-Watch™

FloWatch allows you to use any or all of the Flo-Manager® features but adds additional functionality such as alarms for high flow and low flow situations based on parameters you set and control. See ["Set Flow Limits"](#) for more details.

 *Flow sensing hardware is required to use FloWatch.*

13.1 Flow Sensors

This menu item is the same as Setup - [Flow Sensors](#). If you have already set up a flow sensor then it should appear here.

Learn Flow - **PRO** Models only

The LXME2 controller lets you set the flow rates you expect or to automatically Learn Flow rates based on real usage.

If you do not have flow sensing hardware installed you may be able to estimate flow rates based on the irrigation hardware installed on a particular station or FloZone and manually enter this rate. FloZone flow rates are either:

- Automatically set to the highest station flow rate assigned to the FloZone, or
- Manually adjusted by the user.

Learn Flow Automatically - **PRO** Models only

 To ensure accurate recording of flow rates, do not create any manually-generated flow such as flow created with manually operated quick coupling valves, while a Learn Flow is taking place.

All Stations

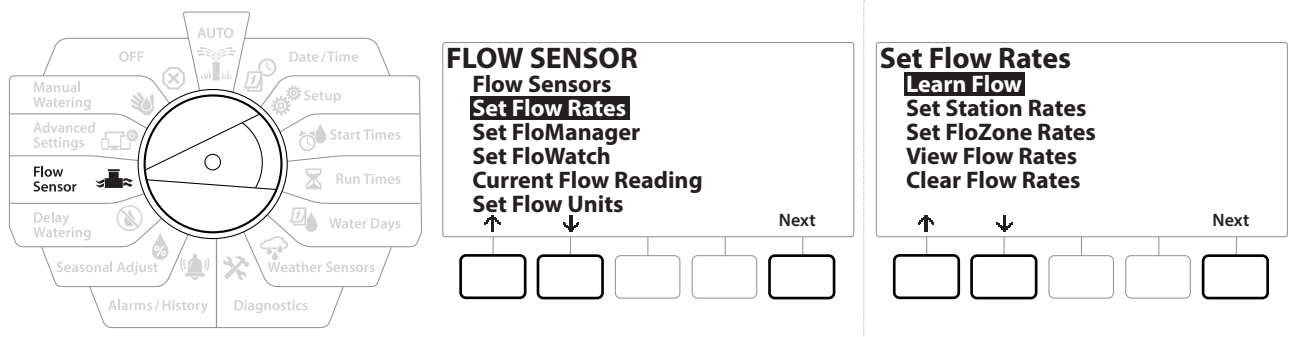

 Ensure you have Run Times set up for all stations included in a Learn Flow exercise prior to setting up a Learn Flow.

- 1** Turn the controller dial to Flow Sensor
- 2** At the FLOW SENSOR screen, with "Set Flow Rates" selected, press Next .
- 3** At the Set Flow Rates screen, with "Learn Flow" selected, press Next .

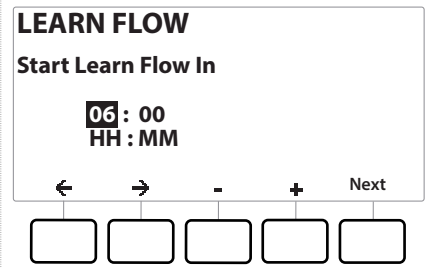
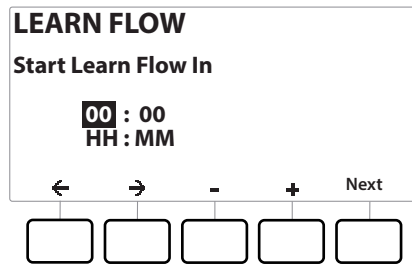
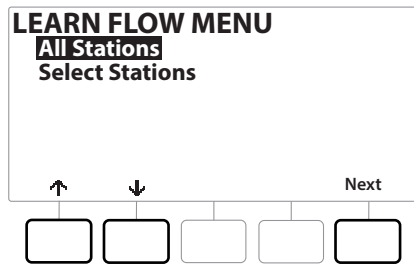

- 4 At the LEARN FLOW MENU screen, with “All Stations” selected, press **Next** .
- 5 A confirmation screen appears; press **Next** again.
- 6 An information screen appears; press **Next** again.
- 7 To start the Learn Flow exercise immediately, press **Next** . Or else press the **+** and **-** keys to set a delayed start time. Press the **←** and **→** to navigate between the number setting fields.

 You can choose to run the exercise Now (00:00) or choose a timed delay of up to 24 hours.

- 8 A confirmation screen appears, confirming the Learn Flow will overwrite the existing flow rates. Press **Start** to set the Learn Flow exercise.
- 9 The Learn Flow Starting confirmation screen shows the time delay until the Learn Flow operation will start.

 An alarm will be posted if one or more stations learn a flow rate of 0 (zero). Check the valve if you receive this alarm.

NOTICE

Be sure to Learn Flow again if you make any changes to your system which affect its hydraulics.

13.1.1 Selected Stations

 Ensure you have Run Times set up for all stations included in a Learn Flow exercise prior to setting up a Learn Flow.

13.1.2 Set Station Rates

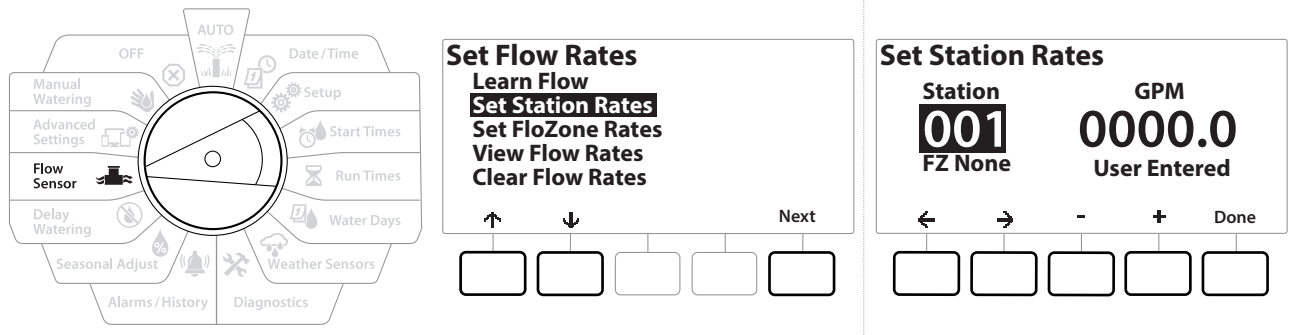

- 1 Turn the controller dial to Flow Sensor
- 2 At the FLOW SENSOR screen, with “Set Flow Rates” selected, press **Next** .
- 3 At the Set Flow Rates screen, press the **↓** key to select “Set Station Rates”, then press **Next** .
- 4 At the Set Station Rates screen, press the **+** and **-** keys to set the desired Station (from 1 to 240), then press the **→** key.
- 5 Press the **+** and **-** keys to set the desired Flow Rate for that station.
- 6 Press the **←** and **→** to navigate between the number setting fields.

 Press and HOLD keys to accelerate settings.

 Repeat this process to manually set up Flow Rates for additional stations as desired.

13.1.3 Set FloZone Rates

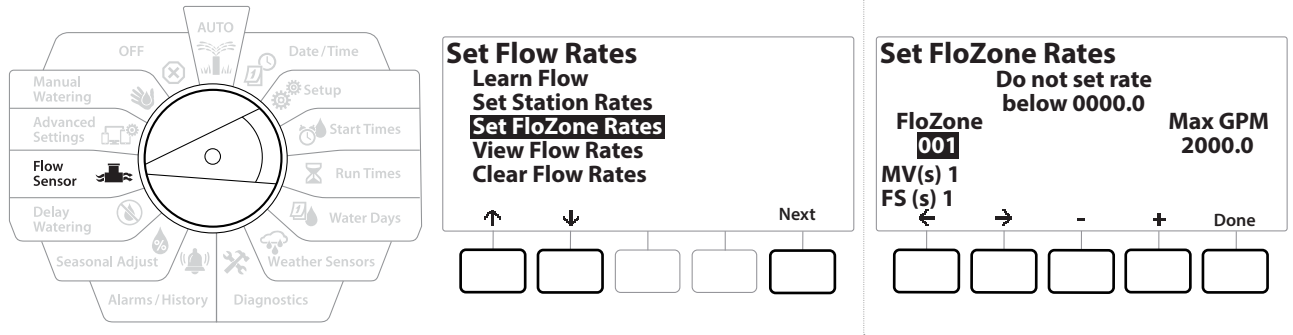

- 1 Turn the controller dial to Flow Sensor
- 2 At the FLOW SENSOR screen, with “Set Flow Rates” selected, press Next .
- 3 At the Set Flow Rates screen, press the ↓ key to select Set FloZone Rates, then press Next .
- 4 The Set FloZone Rates information screen appears; press Next .

The LXME2 features one FloZone.

- 5 Press the right arrow key to navigate to the MAX GPM field.
- 6 Press the + and - keys to set the Max GPM for that FloZone. Press the ← and → to navigate between the number setting fields.

Press and HOLD keys to accelerate settings.

NOTICE

Maximum FloZone flow rates are used only by Flo-Manager®. FloWatch is unaffected by user-entered FloZone flow rates.

- 7 After Flo-Manager® is enabled and station and/or FloZone flow rates are entered, Flo-Manager® works automatically in the background to run stations based on available hydraulic capacity.

Flo-Manager® can be used with or without flow sensing hardware. If flow sensors are not present it will rely on manually entered information; if flow sensors are present it will rely on Learned Flow information, which is typically more accurate.

13.1.4 View Flow Rates

Occasionally you may want to view user entered or learned flow rates and their source for a station or FloZone.

View Flow Rates does not show actual live flow rates but the expected or learned flow rates by station or

FloZone. You can view live flow rates if you have [FloWatch™](#) setup see [Current Flow Reading](#).

View Station Rates

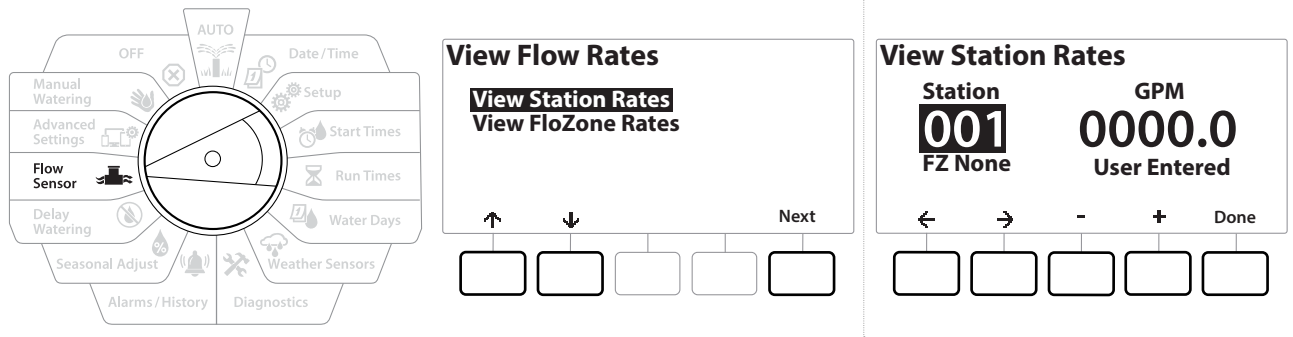

- 1 Turn the controller dial to Flow Sensor
- 2 At the FLOW SENSOR screen, with “Set Flow Rates” selected, press **Next**.
- 3 At the Set Flow Rates screen, press the **↓** key to select “View Flow Rates”, then press **Next**.
- 4 The View Flow Rates screen appears with “View Station Rates” selected; press **Next**.
- 5 At the View Station Rates screen, press the **+** and **-** keys to set the desired station number. The FloZone for each station is shown below it. The normal flow rate for each station will show to the right, and the source of the flow rate (Learned or User Entered) shows below it.

13.1.5 View FloZone Rates

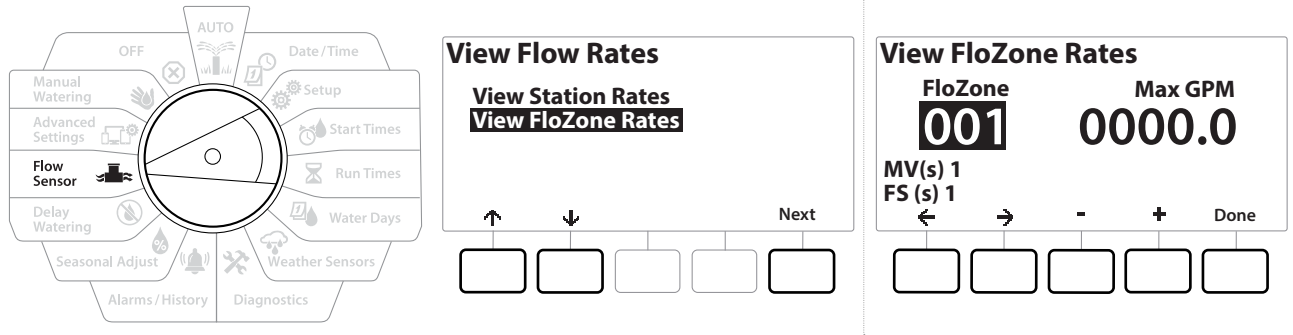

- 1 Turn the controller dial to Flow Sensor
- 2 At the FLOW SENSOR screen, with “Set Flow Rates” selected, press Next .
- 3 At the Set Flow Rates screen, press the ↓ key to select “View Flow Rates”; then press Next.
- 4 At the View Flow Rates screen, press the ↓ key to select “View FloZone Rates”, then press Next .
- 5 At the FloZone Flow Rates screen, press the + and – keys to select the desired FloZone number. The MVs and sensors associated with that flow zone are shown below it. The maximum flow rate for that FloZone will show to the right.

 FloZone rates are used by FloManager. The zone rate cannot be set lower than the highest station rate.

13.1.6 Clear Flow Rates

Occasionally it may be desired to clear the previously learned or user entered flow rates and start over.

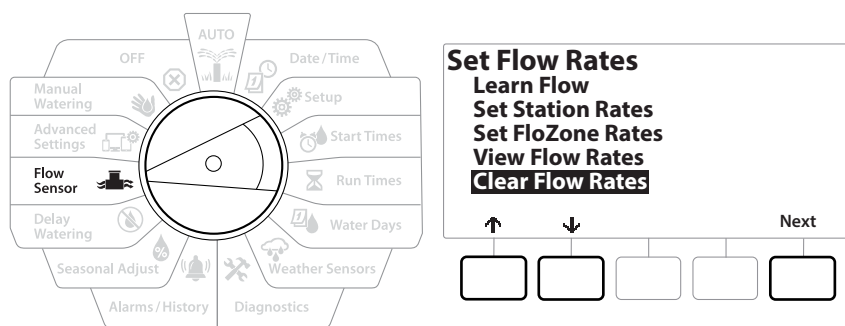

- 1 At the FLOW SENSOR screen, with “Set Flow Rates” selected, press Next .
- 2 At the Set Flow Rates screen, press the ↓ key to select “Clear Flow Rates”, then press Next.
- 3 The confirmation screen appears; press Next to clear flow rates.
- 4 A confirmation screen shows the process is complete.

FloWatch compares current flow conditions to expected, learned or user-entered flow rates and takes various actions based on your settings and input. Since current flow conditions are required, FloWatch can only be used when flow sensors are present. To use FloWatch, you must do all of the following:

- 1** Install flow monitoring hardware into the appropriate locations of your irrigation system. You should install one flow sensor just downstream of each master valve but upstream of any station valves.



Note: To ensure stable readings make sure you follow the manufacturer's instructions when you install the flow sensor.

- 2** Connect the flow sensor to the Pro Smart module, for more details, see "[Connect a Flow Sensor](#)"
- 3** Set up the flow sensors using the flow sensor setup. See "[Flow Sensors](#)" for more details.
- 4** Follow the directions below to set up FloWatch.



Once you have set up FloWatch on the controller, the current flow rate will be shown on the Auto screen unless you turn off [FloWatch™](#).

13.1.11 FloWatch™ Set Up

The LXME2 controller lets you set the flow rates you expect or to automatically Learn Flow rates based on real usage.

Once flow is learned or manually entered, the High Flow and Low Flow settings let you define the parameters for excessive or low flow and to set the behavior of the controller when these conditions are detected. You can also turn FloWatch off or back on again if you like.

FloWatch needs expected flow rates to work properly. Flow rates can be entered manually or can be learned automatically through a Learn Flow process. An automatic Learn Flow operation will Learn Flow for each station that has programmed Run Times. Ensure you have set up run times for all stations included in a Learn Flow exercise prior to setting up a Learn Flow.



Prior to learning or manually setting station flow rates, it is a good idea to check the Master Valve assignments for each of your stations. See "[Station Setup](#)" for more details.

NOTICE

Water pressure, particularly from municipal sources, can vary significantly throughout the day. To mitigate this variance, press the time delay option to delay the Learn Flow start time to when irrigation would normally operate.

13.1.12 FloWatch™ On/Off

- 1 Turn the controller dial to Flow Sensor
- 2 At the FLOW SENSOR screen, press the ↓ key to select “Set FloWatch”, then press Next .
- 3 At the FloWatch screen, with “FloWatch On/Off” selected press Next .
- 4 Press the On key to turn on FloWatch, or else press Off to disable.



Once FloWatch is enabled we recommend that you Learn Flow or manually enter flow for all stations and FloZones if you have not already done so. This will allow FloWatch to react appropriately to the High Flow and Low Flow settings.

13.1.13 Set Flow Limits

SEEF: seek and eliminate excessive flow (High Flow)

SELF: seek and eliminate excessive flow (Low Flow)

To most effectively use FloWatch™, you will want to first set your High Flow and Low Flow thresholds and actions. SEEF (High Flow) stands for Seek and Eliminate Excessive Flow and deals with how you want the controller to respond when excessive flow is occurring, as might be the case with a mainline break or a valve which is stuck in the open position. SELF (Low Flow) stands for Seek and Eliminate Low Flow and deals with what the controller should do when low flow is present, as might be the case during a pump failure, municipal water supply issue or when a valve fails to open.

13.1.14 Set Up and Configure High Flow and Low Flow

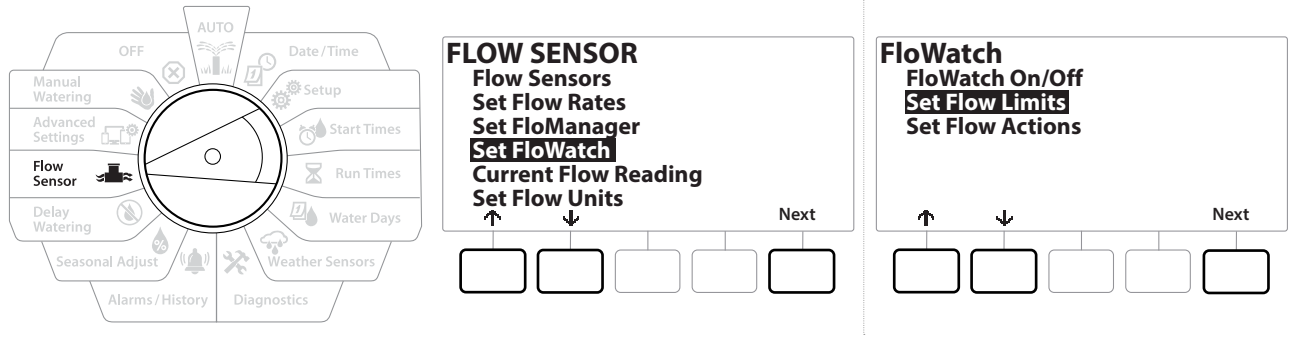

- 1 Turn the controller dial to Flow Sensor
- 2 At the FLOW SENSOR screen, press the ↓ key to select “Set FloWatch”, then press Next .
- 3 At the FloWatch screen, press the ↓ key to select “Set Flow Limits”, then press Next .
- 4 At the High Flow Settings screen, press the + and - keys to set the desired High Flow Threshold percentage (Max. 200%). Then press the ↓ key.
- 5 Press the + and - keys to set the desired High Flow settling time (Up to 10 minutes), then press Next .

 Press and HOLD keys to accelerate settings.

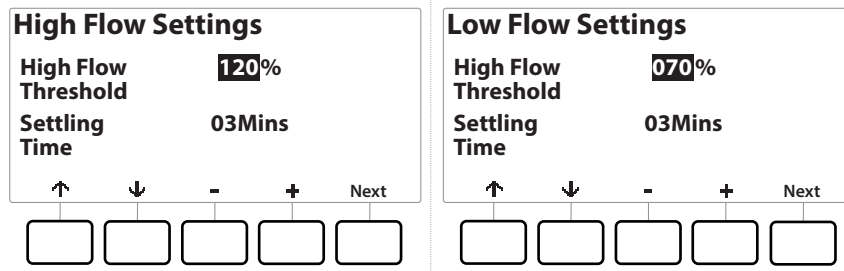

- 6 At the Low Flow Settings screen, press the + and - keys to set the desired Low Flow Threshold percentage (Max. 95%). Then press the ↓ key.
- 7 Press the + and - keys to set the desired Low Flow settling time (Up to 10 minutes).

 Press and HOLD keys to accelerate settings.

13.1.15 Set Flow Actions

There are 3 options available to Set Flow Actions during High or Low flow:

- Diagnose & Eliminate
 - Shut Down & Alarm
 - Alarm Only
- 1** Turn the controller dial to Flow Sensor
 - 2** At the FLOW SENSOR screen, press the ↓ key to select “Set FloWatch”, then press Next .
 - 3** At the FloWatch screen, press the ↓ key to select “Set Flow Actions”, then press Next .
 - 4** At the Action Under High Flow screen, press the + and – keys to set the desired option to occur under High Flow, then press Next
 - 5** At the Action Under Low Flow screen, press the + and – keys to set the desired option to occur under Low Flow, then press Next
 - 6** At the Re-enable time screen, press the + and – keys to set the desired number for hours (from 0 to 23). Press the Arrow keys to navigate between the number setting fields. Set the minutes (from 0 to 59).

13.1.16 Current Flow Reading

Occasionally it may be useful to check the current flow rate in a particular FloZone and how that compares to previously learned or user input station flow rates.



- 1** Turn the controller dial to Flow Sensor
- 2** At the FLOW SENSOR screen, press the ↓ key to select “Set Current Flow Reading”, then press Next .
- 3** At the View Current Flow screen, press the + and – keys to select the desired FloZone number. Current and expected flow will show.



Expected flow is from previously user-entered or learned station flow rates. The deviation or percentage comparison of current flow to expected flow will show so you can see how close each FloZone is to a High Flow or Low Flow condition (see [Setting Up High Flow and Low Flow](#) for more details).

13.1.17 Set Flow Units

To use Flo-Manager® or FloWatch™ with the LXME2 controller, you first need to set the measurement units for flow management.

- 1 Turn the controller dial to Flow Sensor
- 2 At the FLOW SENSOR screen, press the  key to select “Set Flow Units”, then press **Next** .
- 3 At the Set Flow Units screen, press the **+** and **-** keys to set the desired flow rate (M3/Hr, Auto, GPM, LPS, or LPM). Then navigate to the Pipe size selection by pressing the  key.
- 4 Press the **+** and **-** keys to set the desired pipe size measurement (Auto, Inch, or mm).



If Auto is selected, Flow Rate will default to GPM when 60 Hz is detected and to LPS when 50 Hz is detected. Pipe Size will default to Inches on 60 Hz and to millimetres on 50 Hz.

14. **ADVANCED SETTINGS**

14.1.1 **Store/Recall Programs**

The LXME2 controller comes standard with a simple to use backup programs feature.

Backup Programs allows you to save your programs as Contractor Default and then recall them at a later time. It also includes a Delayed Recall feature that lets you save a normal irrigation schedule as the Backup and then restore it later automatically. This may be useful for new seed or sod where frequent irrigation can be programmed to occur until a set date when Delayed Recall automatically returns the controller programming to the normal irrigation schedule.

NOTICE

The Backup Programs feature saves and restores ALL irrigation programming in ALL programs.

Store Programs

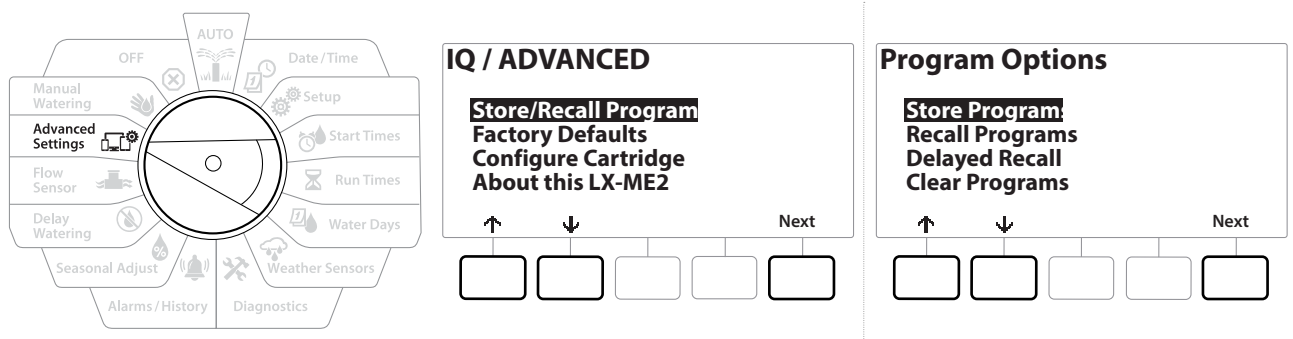

- 1 Turn the controller dial to Advanced Settings
- 2 At the IQ / ADVANCED screen, with "Store/Recall Programs" selected, press **Next**.
- 3 At the Program Options screen, with "Store Programs" selected, press **Next**.
- 4 At the confirmation screen, press and HOLD the **Yes** key for 4 seconds to Store All Programs. If you're not sure, press **No**.
- 5 A confirmation screen shows the process is running.
- 6 A confirmation screen shows the process is complete.

Recall Programs

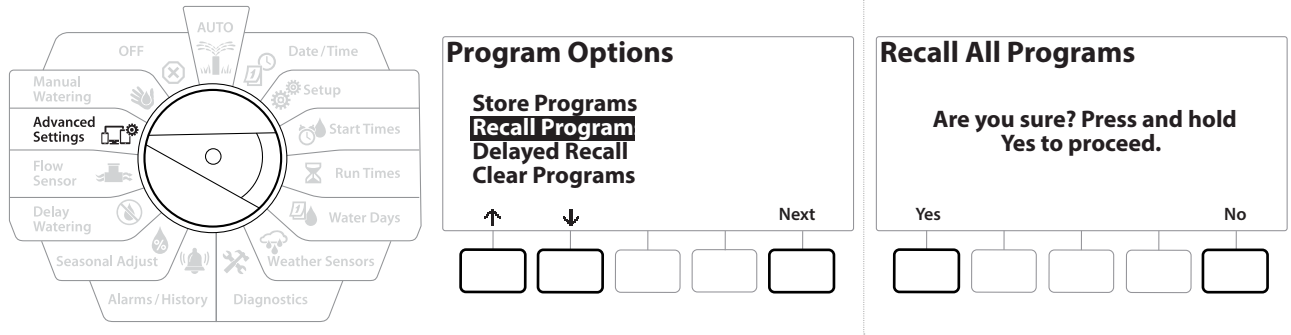

- 1 Turn the controller dial to Advanced Settings
- 2 At the IQ / ADVANCED screen, with "Store/Recall Programs" selected, press **Next** .
- 3 At the Program Options screen, press the ↓ key to select "Recall Programs"; then press **Next**.
- 4 At the confirmation screen, press and HOLD the **Yes** key for 4 seconds to Recall All Programs. If you're not sure, press **No**.
- 5 A confirmation screen shows the process is running.
- 6 A confirmation screen shows the process is complete.

Delayed Recall Programs

Use the Delayed Recall feature to automatically replace the currently loaded programs with a previously stored program at a future date.

NOTICE

Once current programs have been replaced with the Delayed Recall feature, they can not be restored.

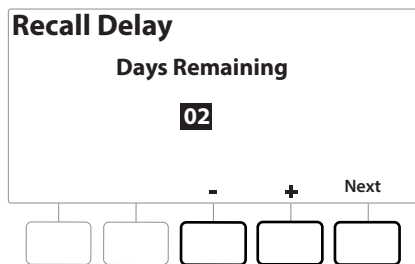
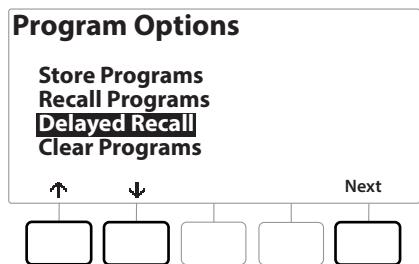
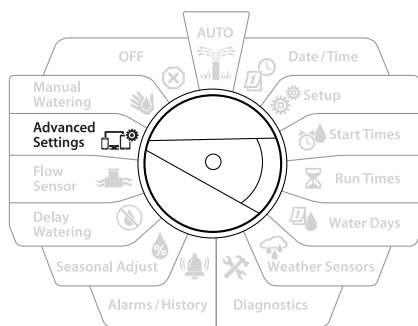

- 1 Turn the controller dial to Advanced Settings
- 2 At the IQ / ADVANCED screen, with “Store/Recall Programs” selected, press **Next** .
- 3 At the Program Options screen, press the ↓ key to select “Delayed Recall”; then press **Next**.
- 4 At the Recall Delay screen, press the + and - keys to set the number of days (from 0 to 90 days) before Contractor Defaults are restored. For example, set it to 7 days if you want your original programs to be restored in one week.

 To clear a Delayed Recall, set the number of days to 0.

Clear Program Information

The LXME2 controller allows you to clear an individual Program, all of your Programs or Restore the controller to it’s factory default condition.

NOTICE

It’s recommended to back up your Programs before clearing them. The LXME2 controller’s built in Store Programs feature can backup one set of programs. See “[Store/ Recall Programs](#)” for more details.

 Irrigation start days, Start Times and station Run Times will no longer be present for the cleared Programs. If no Programming exists then an Alarm will be shown. See “[Alarms](#)” for more details.

Clear Individual Program

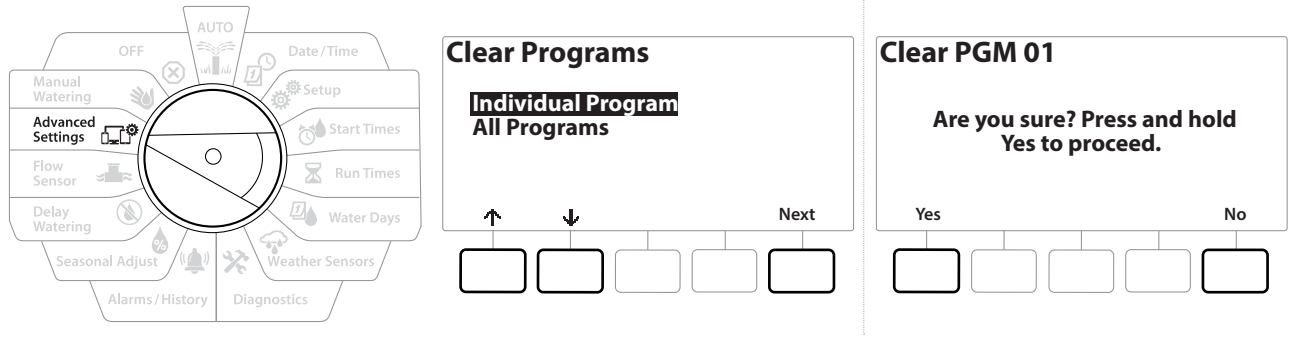

- 1 Turn the controller dial to Advanced Settings
- 2 At the IQ / ADVANCED screen, with "Store/Recall Programs" selected, press **Next** .
- 3 At the Program Options screen, press the **↓** key to select "Clear Programs", then press **Next** .



If the desired program is not selected, press the Program Select button to choose the desired program. See "[Program Select Button](#)" for more details.

- 4 At the Clear Programs screen with "Individual Programs" selected; press **Next** .
- 5 At the confirmation screen, press and HOLD the **Yes** key for 4 seconds to Clear Programs. If you're not sure, press **No**.
- 6 A confirmation screen shows the process is complete.



Use the Program Select button to change the current program and repeat this process to clear other programs.

Clear All Programs

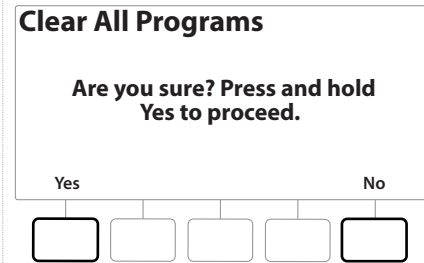
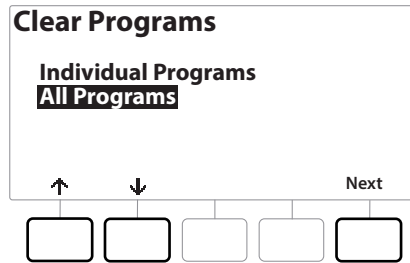
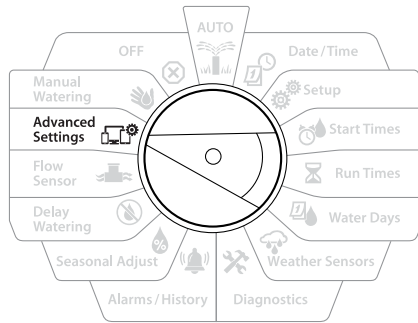

- 1 Turn the controller dial to Advanced Settings
- 2 At the IQ / ADVANCED screen, press the ↓ key to select “Store/Recall Programs”, then press Next .
- 3 At the Program Options screen, press the ↓ key to select “Clear Programs”, then press Next.



If the desired program is not selected, press the Program Select button to choose the desired program. See [“Program Select Button”](#) for more details.

- 4 At the Clear Programs screen, press the ↓ key to select “All Programs”, then press Next .
- 5 A confirmation screen shows the process is complete.

14.1.2 Factory Defaults

Restore the LXME2 controller’s factory default settings.

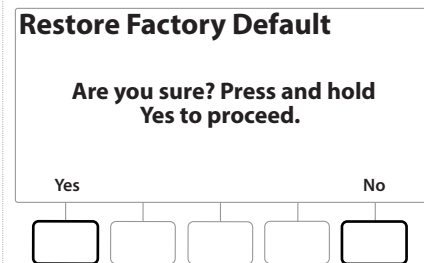
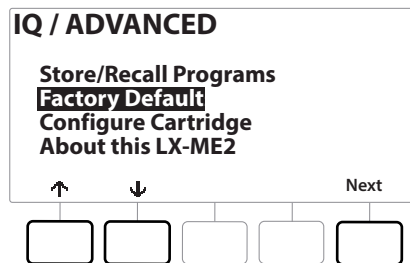
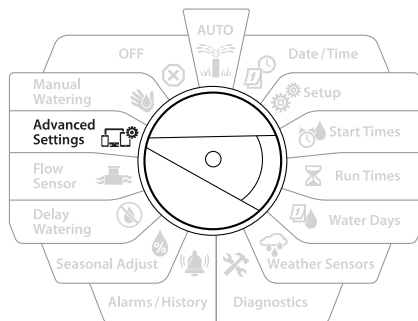

- 1 Turn the controller dial to Advanced Settings
- 2 At the IQ / ADVANCED screen, press the ↓ key to select “Factory Defaults”, then press Next.
- 3 At the confirmation screen, press and HOLD the Yes key for 4 seconds to Restore Factory Defaults. If you’re not sure, press No.
- 4 A confirmation screen shows the process is complete.

14.1.3 About this LXME2

- 1 Turn the controller dial to Advanced Settings
- 2 At the IQ / ADVANCED screen, press the  key to select "About this LXME2", then press Next.
- 3 The ABOUT LXME2 screen appears with an overview of your LXME2 including the information of the version, front panel and cartridge
- 4 Press the More button for an overview of the slots of your LXME2.

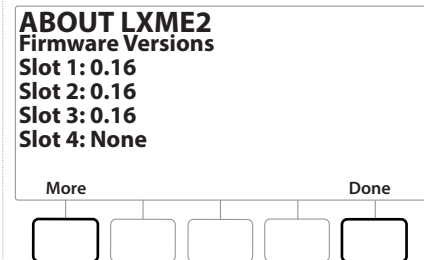
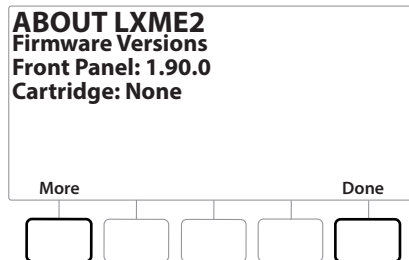
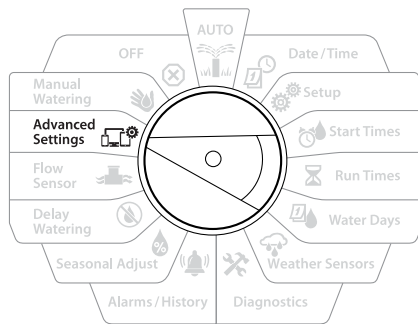

15. MANUAL WATERING

The LXME2 controller allows you to manually start a station, a program, or to open a Normally Closed Master Valve (NCMV) to provide water to a for manual watering.

15.1.1 Start Station

 *Manual Watering > Start Station will pause currently running programs.*

 *Ensure device addresses are present and entered correctly prior to Manual Station or Manual Program operations.*

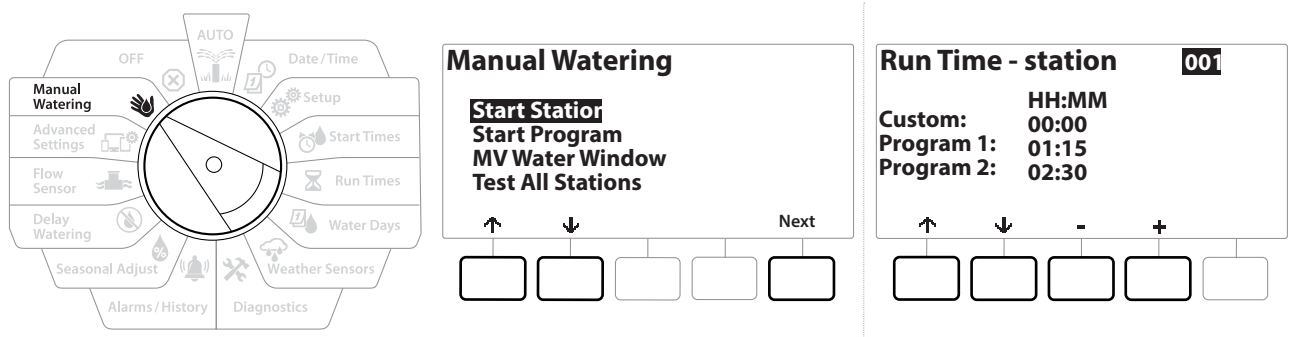

- 1 Turn the controller dial to Manual Watering
- 2 At the Manual Watering screen, with "Start Station" selected, press Next .
- 3 At the Run Time - Station screen, press the + and - key to select the desired station (from 1 to 240) to run manually.
- 4 Press the Arrow keys to set the station Run Time (from 0 hours, 1 minute to 96 hours). Press the Run key to start irrigation for that station.

 *Press and HOLD keys to accelerate settings.*

- 5 A confirmation screen shows that irrigation has started.

 *Repeat this process to manually water other stations*

 *Stations will run sequentially in the order in which they were selected.*

- 6 To view the Station while running, turn the controller dial to the AUTO position. Press the + and - keys to add or subtract minutes from the run time for the currently running station. To advance to the Next station in a program, press the Adv key.

15.1.2 Start Program

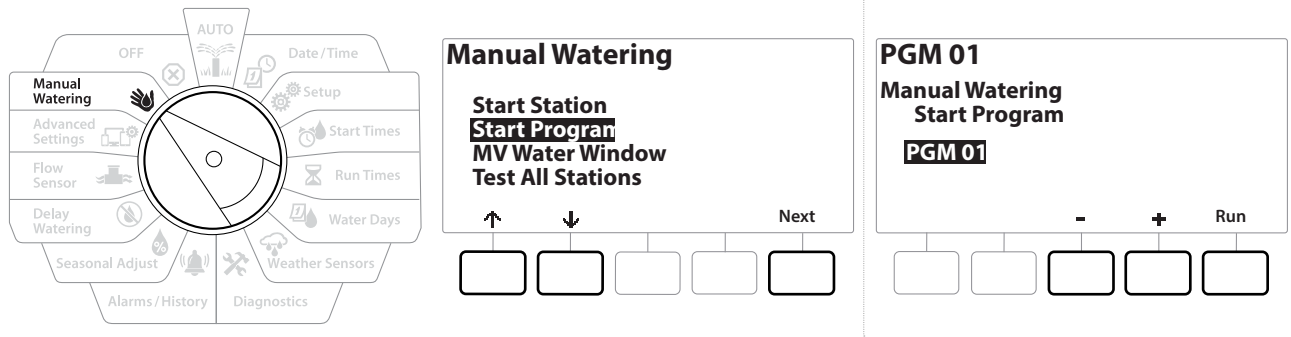

- 1 Turn the controller dial to Manual Watering
- 2 At the Manual Watering screen, press the \downarrow key to select "Start Program", then press Next .
- 3 At the Manual Watering Start Program screen, press the $+$ and $-$ keys to set the desired program, then press Run to start irrigation.
- 4 A confirmation screen shows that irrigation has started.

 Repeat this process to manually start other Programs.

 Programs will run sequentially in the order in which they were selected.

15.1.4 MV (Master Valve) Water Window

Sometimes you may want to use quick coupling valves or other manual watering methods during times when you are not irrigating.

To ensure that these devices have water, you can set up an MV Water Window. The MV Water Window works the same way as other Water Windows, but instead of allowing irrigation it simply opens a Normally Closed Master Valve (NCMV) and allows a user-defined flow rate to coordinate with flow sensing.

Set Up MV Water Window

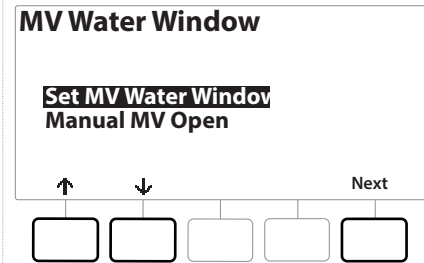
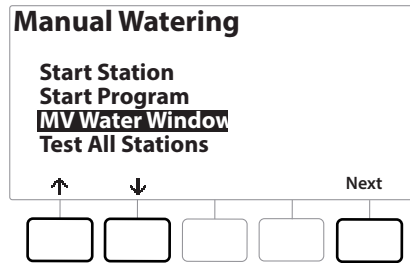
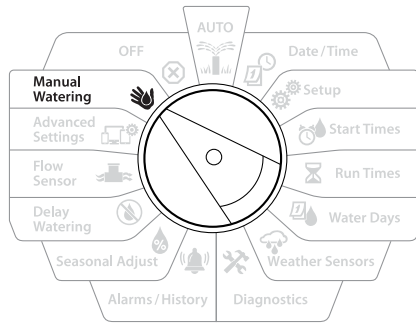

- 1 At the Manual Watering screen, press the **↓** key to select “MV Water Window”, then press **Next**.
- 2 At the MV Water Window screen, with “Set MV Water Window” selected, press **Next**.

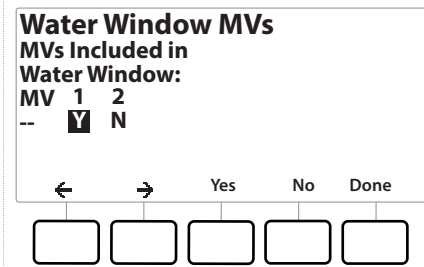
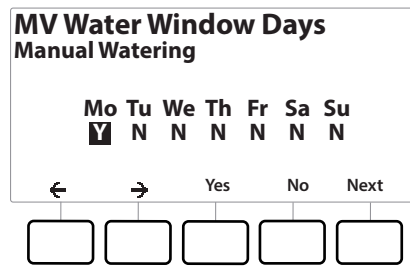
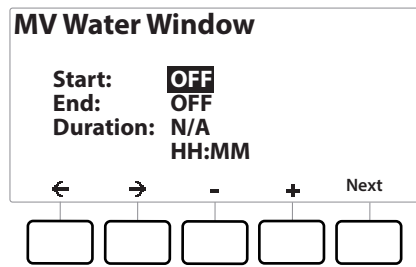

- 4 Press the **+** and **-** keys to set the MV Water Window Start time.
- 5 Press the Arrow keys to navigate between the number setting fields.
- 6 Press the **+** and **-** keys to set the time when the End time. The duration of your MV Water Window calculates automatically, then press **Next**.

Press and **HOLD** keys to accelerate settings.

To clear a previously set MV Water Window, press the **+** and **-** keys to set both the Open and Close times to OFF (between 11:59 PM and 12:00 AM).

- 7 At the MV Water Window Days screen, press the **Yes** key to allow MV Manual Watering to occur on a given day or press **No** to exclude that day. Press **Next** to advance past Sunday.
- 8 At the Water Window MVs screen, press the **Yes** key to include the selected Master Valve in the Water Window, or press **No** to exclude that MV.

⚠ WARNING

If Water Windows are selected for Pump starts the pump will dead head.

16. OFF

Use this Dial position to turn off irrigation, master valve or pump and adjust display contrast.

16.1.1 Adjust Display Contrast

For better visibility, you can adjust contrast values of the controller display from 1-12 in the OFF position.

- 1 Turn the controller dial to OFF
- 2 At the All Watering Off screen, press the **+** and **-** keys to adjust contrast up or down (from 0 to 12).

16.1.2 Close Master Valves

Closes all master valves, disabling irrigation.

NOTICE

Using the MV Close function will disable all irrigation functions.



The Close Master Valves function closes Normally Open Master Valves. Normally Closed Master Valves remain closed.

- 1 Turn the controller dial to OFF
- 2 At the All Watering Off screen, press the **MV Close** key.
- 3 At the confirmation screen, press and HOLD the **Yes** key for 4 seconds to Close Master Valves. If you're not sure, press **No**.
- 4 A confirmation screen shows the MV has closed.
- 5 The OFF dial position screen will now show the message "All MVs Closed. To cancel and restore irrigation functions, turn the dial to AUTO".

17. INSTALLATION

17.1 Install the Controller

This section explains how to mount the LXME2 controller on a wall (or mounting surface) and connect the wiring.

 An optional metal cabinet (LXMM) and pedestal (LXMMPED) or stainless steel cabinet (LXMM-SS) and pedestal (LXMMPED-SS) are also available for the LXME2 controller. If you intend to purchase those options then follow the installation instructions included with those items and proceed to the Install Modules section below.

⚠ WARNING

This controller must be installed in compliance with local electrical codes.

17.1.1 Installation Checklist

When installing the LXME2 controller for the first time, it is recommended that you complete the following steps in order.

For your convenience a check-off box is provided for each step.

Check box contents	<input type="checkbox"/>
Select a location	<input type="checkbox"/>
Gather installation tools	<input type="checkbox"/>
Mount the controller	<input type="checkbox"/>
Connect source power	<input type="checkbox"/>
Install base and station module[s]	<input type="checkbox"/>
Connect field wiring	<input type="checkbox"/>
Complete the installation	<input type="checkbox"/>

17.1.2 Check Box Contents

All components below are included with your LXME2 controller and are required for installation. If anything is missing, please contact your distributor before proceeding.

- LXME2 controller
- Controller cabinet keys
- Mounting hardware (5 screws, 5 plastic wall anchors)
- Quick Start Guide/ Programming Guide
- Controller mounting template
- Station Numbering Labels

17.2 **Select Location for Controller**

Select a location that:

- Easily accessible and allows for comfortable viewing
- Has a flat wall surface
- Near 120 VAC or 230/240 VAC power source (depending on model)
- Is safe from potential vandalism
- Is outside the range of operating sprinklers

17.2.1 **Gather Installation Tools**

Before beginning installation, gather the following tools and materials:

- Slotted Head Screwdriver
- Philips Head Screwdriver
- Thin Blade Screwdriver
- Lineman's Pliers
- Torpedo Level
- Hammer
- Grounding Strap
- #8 AWG or #10 AWG Bare Ground Wire
- WC20 Waterproof Wire Connectors
- Tape Measure
- Wire Stripper
- Wire Nuts (provided)
- Marking Pencil
- Electric drill (or Hammer Drill if installing in masonry or concrete wall)
- Waterproof Caulking

17.2.2 Access Controller Cabinet

- 1** The controller comes with an outer door lock to deter vandalism and prevent unauthorized access to controller operations. If necessary, unlock the cabinet door using the supplied key.
- 2** Grasp the handle on the right-hand-side of the outer cabinet and pull it towards you to open the door, swinging it to the left.
- 3** Open or Remove Controller Front Panel. Grasp the handle on the right-hand-side of the controller front panel and pull it towards you to open the cabinet, swinging it to the left.
- 4** To remove the front panel: disconnect the ribbon cable from the front panel by gently pulling the connector out of the socket.

NOTICE

Be careful not to bend the pins in the sockets when attaching or detaching the ribbon cable.

- 5** Rock the front panel upward and nudge the bottom corner pin out of the lower pin-hole to remove the front panel.

17.3 Mount the controller



Before mounting the controller, we recommend that you remove the controller front panel, plus the LXME2 Base Module and/or any station modules if previously installed.

- 1 Using a level, tape the mounting template to the mounting surface at approximately eye level. Make sure that at least one of the five mounting hole marks is aligned on a wall stud or other solid surface.
- 2 Use a tapping tool (or nail) and hammer to tap pilot holes through the five mounting hole marks and into the mounting surface.
- 3 Then remove the template and drill holes in the mounting surface, installing wall anchors if necessary.
- 4 Drive the first screw into the top most-center hole. Then hang the controller on the screw by the key-hole slot on the back of the cabinet.
- 5 Line up the controller cabinet mounting holes with the remaining pilot holes and drive the four remaining screws through the cabinet back plane into the mounting surface.
- 6 Connect Power to the Controller
- 7 Surge Protection and Grounding
- 8 The LXME2 controller is equipped with built-in electrical surge protection. For this system to function, you must properly ground the controller.

⚠ WARNING

The LXME2 controller must be properly surge protected and grounded. Doing so can help prevent damage to the controller and irrigation system and also significantly reduce troubleshooting, repair time and expense. Failure to do so could result in failure of your controller and voiding the warranty.

Ensure that all grounding devices are compliant with local electrical codes.

17.4 Connect source power

The ESP-LXME2 controller has an internal transformer that reduces supply voltage (120 VAC in U.S. models; 230 VAC in international models; 240 VAC in Australian models) to 24 VAC. You will need to connect power supply wires to the transformer's three wires. (Line, Neutral, Ground)

⚠ WARNING

Electric shock can cause severe injury or death. Make sure power supply is turned OFF before connecting power wires. All electrical connections and wiring runs must be made according to local building codes.

- 1 Locate the transformer wiring compartment in the lower left corner of the controller cabinet. Remove the screw on the right-hand side and pull the cover off to expose the wiring compartment.

17.4.1 Install base and station module (BCM or PSM)

- 1 Install Base Module (BM2-LXME) or ProSmart module (PSM-LXME2) in Slot 0.

CAUTION:

Be careful not to bend the pins in the sockets when installing the module.

 *The Base and Flow Smart Module include a jumper wire connecting the weather sensor (SEN) terminals. Do not remove the jumper wire unless you install a weather sensor.*

- 2 Orient the connector on the bottom of the module with the connection socket in Slot 0 on the controller backplane.
- 3 Carefully fasten the module onto the controller backplane, pressing firmly until it snaps into place. The red light on the module will flash on and off once if the module is installed correctly. If the light does not flash once, verify the module is seated correctly.

 *To remove the module, press in on the (two) release buttons on either side of the module.*

17.4.2 Install Station Module

Install a 12 station module in Slot 1 that was included with your LXME2 controller. Additional station modules can be purchased separately.

 *The LXME2 is only compatible with 12 station modules (ESPLXM-SM12) and will not work with 8 or 4 station modules.*

CAUTION:

Be careful not to bend the pins in the sockets when installing the module.

- 1 Orient the connector on the bottom of the station module with the connection socket in Slot 1 on the controller backplane.
- 2 Carefully fasten the module onto the controller backplane, pressing firmly until it snaps into place. The red light on the module will flash on and off once if the module is installed correctly. If the light does not flash once, verify the module is seated correctly.

 To remove a module, press in on the (two) release buttons on either side of a module.

17.5 Dynamic Station Numbering

A Module Configuration screen is displayed whenever the LXME2 Controller detects a change in module configuration. The Module Summary screen displays the module type detected in each module slot along with the station numbers. With the Module Labels screen displayed. Locate the Module Station Numbering Labels that are provided on a separate foldout sheet.

The Module Station Numbering Screen displays a pair of letters (example: Slot 1 = Label AC) for each installed module. Find the station numbering label on the foldout sheet with the matching letter pair and place it over the blue strip on the module. This label shows which station number each terminal block is mapped to.

1	SM12 AC	01 ↓ 12	25 ↓ 36	SM12 BG	3
2	SM12 AL	13 ↓ 24	37 ↓ 48	SM12 BP	4
Done					
<input type="checkbox"/>	<input type="checkbox"/>	<input type="checkbox"/>	<input type="checkbox"/>	<input type="checkbox"/>	

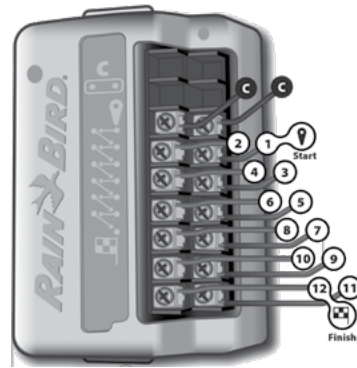

 For alternate station numbering see [Module/ Station Numbering](#)

17.5.1 Connect Field Wiring

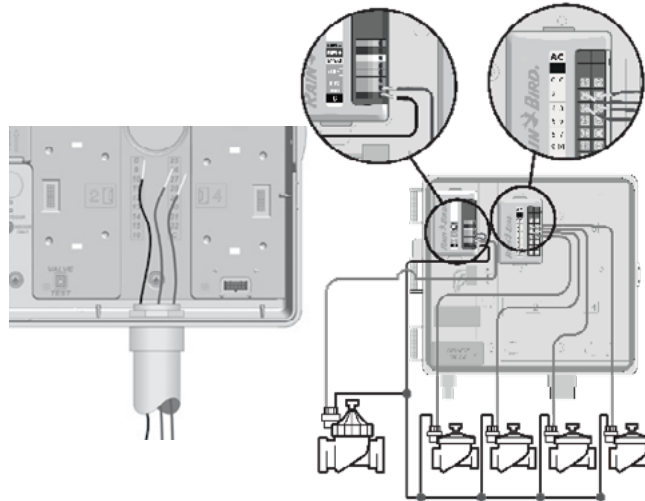

- 1 Locate (or remove) the large knockout on the bottom of the controller cabinet.
- 2 Attach a conduit fitting to the bottom of the cabinet; then attach conduit to the fitting.
- 3 Feed the field wires through the conduit and into the controller cabinet.
- 4 Strip the wire jacket back by a maximum of 1/2 inch (12 mm) and connect each valve wire to one of the numbered terminals on a station module.
- 5 Field wires for valves are connected to module terminals using screw terminal blocks, loosen the screws of the appropriate terminal using a Philips screw driver.
- 6 Insert the wire. Then tighten the screw to clamp the wire in place.
- 7 Connect the common wire(s) to any one of the COM terminals on the controller. Wires used to connect the valves must be code approved for underground installation.



Complete the following step only if your system uses a master valve or a pump start relay. The controller does not provide main power for a pump.

- 8 Connect the master valve or pump start relay wiring to the MV and COM terminals.
- 9 Once wiring is completed, fill top of conduit with waterproof caulking to prevent insect intrusion into the controller cabinet.

17.5.2 Connect Local Weather Sensor

The LXME2 can accept input from a single weather sensor wired directly to the controller or through a wireless receiver.

A local weather sensor can be bypassed from the [Weather sensor setup screen](#).

To Enable a Local Weather Sensor see [Weather Sensors](#).



Follow the sensor manufacturer's instructions to correctly install and make wire connections to the sensor. Ensure the sensor installation is in compliance with all local codes.



If your weather sensor requires 24V power from the controller, the + and - connectors to the left of the sensor and common connectors can be used.

- 1** Run continuous sensor wire from the weather sensor to the LXME2 controller.
- 2** Route wire through knockout on the bottom of the controller.
- 3** Remove the yellow jumper wire (if present). Connect the two sensor wires to the sensor (Sen) inputs. When finished, tug gently on the wires to make sure the connections are tight.



Ensure that the configuration for your controller and irrigation programs are set up correctly for your sensor. For example, if one of your programs is set up to manage your landscape lighting you may want to ensure that it's stations ignore input from a local weather sensor. See [Weather Sensor](#), for more details.

- 4** Complete the installation
- 5** Install Front Door
- 6** Line up the three door hinges with the plastic posts on the controller.
- 7** Press the hinges onto the posts until the front door snaps into place.

17.5.3 Connect a Flow Sensor - **PRO** Models Only

A Pro Smart Module (PSM-LXME2) is required to connect a Flow Sensor and use FloWatch, Learned Flow utility and Flow Alarm/ water use recording.



You may have to replace the BM2-LXME Base Module with the PSM-LXME2 Flow Smart Module, depending on the configuration you purchased.



The Pro Smart Module includes a jumper wire connecting the weather sensor (SEN) terminals. Do not

remove the jumper wire unless you install a weather sensor.

- 1** Install the flow sensor in the field according to the manufacturer's instructions, and run the flow sensor wire to the ESP-LXME2 controller.
- 2** Use a separate PE-39 #19 AWG cable for connecting the flow sensor to the Pro Smart Module. The maximum wire run length is 2000 feet (610 meters).
- 3** The connection from the PE-39 cable to the flow sensor must be made with direct burial type connectors. Use Rain Bird WC20 or 3M DBR/Y-6 splice kits only.
- 4** Minimize wire splices.
- 5** Any cable with broken, torn, or damaged insulation should be replaced.
- 6** Route the flow sensor wire through the knockout on the bottom of the controller.
- 7** Connect the flow sensor wire to the Flow + and Flow - inputs. When finished, tug gently on the wires to make sure the connections are tight.



For Rain Bird FS-Series flow sensors, connect the red sensor wire to the red (+) terminal and the black sensor wire to the grey (-) terminal.

17.5.4 Verify Field Installation

- 1** Once some or all valves have been wired and programmed into the LXME2 controller you can check the electrical portion of the installation even if water is not available to test the valves.
- 2** If water is available and you would like to test some or all of your stations, the easiest way to do so is by using the Test All Stations feature of the controller. See [Test all Stations](#) for more details.

<p>Rain Bird Corporation 6991 East Southpoint Road Tucson, AZ 85756 USA</p> <p>Tel: (520) 741-6100</p>	<p>Rain Bird Europe SNC Rain Bird France SNC 240 rue René Descartes Bâtiment A, Parc Le Clamar BP 40072 13792 AIX-EN-PROVENCE CEDEX 3 FRANCE</p> <p>Tel: (33) 4 42 24 44 61 rbe@rainbird.eu www.rainbird.eu rbf@rainbird.eu www.rainbird.fr</p>
<p>Rain Bird Corporation 970 W. Sierra Madre Ave. Azusa, CA 91702 USA</p> <p>Tel: (626) 812-3400</p>	<p>Rain Bird Deutschland GmbH Königstraße 10c 70173 Stuttgart DEUTSCHLAND</p> <p>Tel: +49 (0) 711 222 54 158 rbd@rainbird.eu</p>
<p>Rain Bird Australia Pty Ltd. Unit 13, Level1 85 Mt Derrimut Road PO Box 183 Deer Park, VIC 3023</p> <p>Tel: 1800 724 624 info@rainbird.com.au www.rainbird.com/au</p>	<p>Rain Bird International 1000 W. Sierra Madre Ave. Azusa, CA 91702 USA</p> <p>Tel: +1 (626) 963-9311</p>
<p>Rain Bird Ibérica S.A. C/ Valentín Beato, 22 2a Izq. fdo 28037 Madrid ESPAÑA</p> <p>Tel: (34) 91 632 48 10 rbib@rainbird.eu www.rainbird.es portugal@rainbird.eu www.rainbird.pt</p>	<p>Rain Bird Brasil Ltda. Rua Marques Póvoa, 215 Bairro Osvaldo Rezende Uberlândia, MG, Brasil CEP 38.400-438</p> <p>Tel: 55 (34) 3221-8210 www.rainbird.com.br</p>
<p>Technical Services for U.S. and Canada only: 1 (800) RAINBIRD 1-800-247-3782 www.rainbird.com</p>	<p>Rain Bird Turkey Çamlık Mh. Dinç Sokak Sk. No.4 D:59-60 34760 Ümraniye, İstanbul TÜRKİYE</p> <p>Tel: (90) 216 443 75 23 rbt@rainbird.eu www.rainbird.com.t</p>

© 2022 Rain Bird Corporation

"Rain Bird" and "Flo-Manager" are registered trademarks of Rain Bird Corporation.

D42069 Rev.01/22