

Think Tank Think ENDURATANK

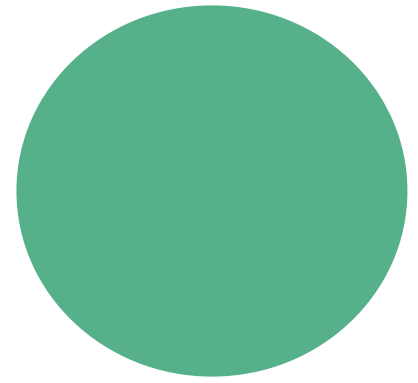

VERTICAL TANK TECHNICAL SPECIFICATION

NON POTABLE	172115		
CAPACITY (Litres)	5000	CAPACITY (Gallons)	1100

A (mm)	1900	B (mm)	620
C (mm)	2300	Standard Outlet	2"

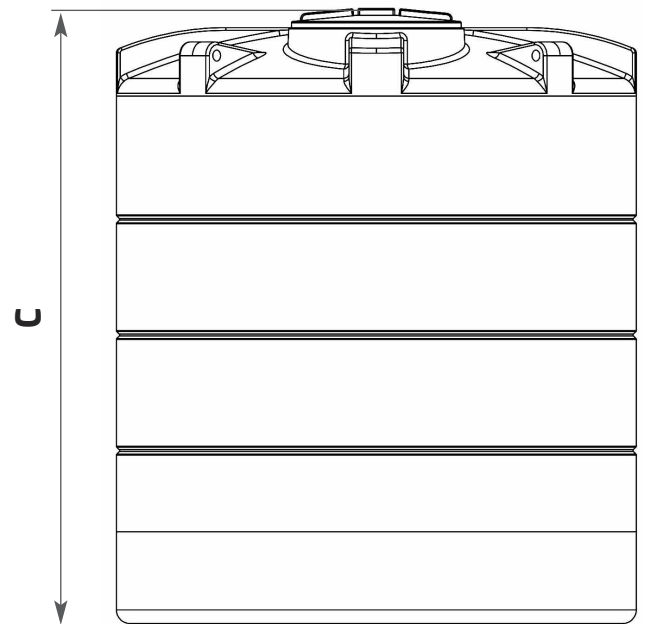
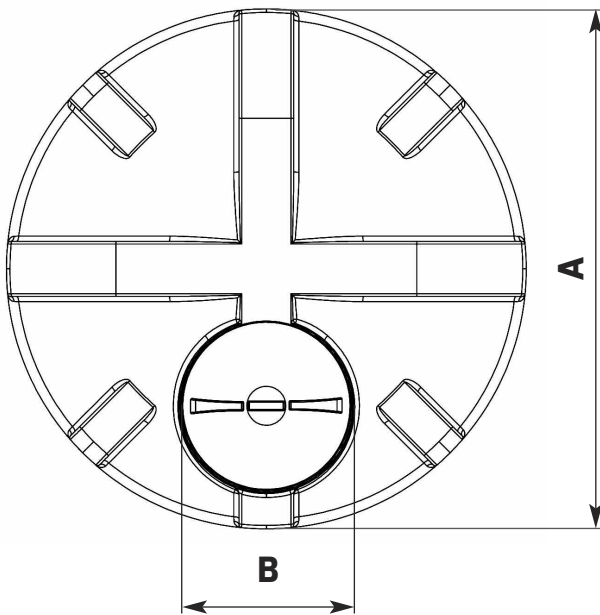

Please note:
Tank sizes quoted are subject to a +/- 3% variation

ENDURATANK[®]
A Division of ENDURAMAXX

© Enduramaxx 2017. Copyright of this drawing is reserved by Enduramaxx. The issue of this drawing is confidential disclosure of its contents, and is made conditional that it is neither disclosed to a third party, nor any item described herein and designed by Enduramaxx is produced either in whole or in part without the written consent of Enduramaxx.

Enduratank is a Registered Trading Name of Enduramaxx Limited

