

Qty. Description

1 CME 3-3 A-R-I-E-AQQE U-A-D-N

Product No.: [98394972](#)

Compact, reliable, horizontal, multistage, end-suction centrifugal pump with axial suction port and radial discharge port. Pump materials in contact with the liquid are in stainless steel. The mechanical shaft seal is a special designed, unbalanced O-ring seal. Pipework connection is via internal Whitworth pipe threads, Rp (ISO 7/1).

The pump is fitted with a 1-phase, fan-cooled, permanent-magnet, synchronous motor. The motor efficiency is classified as IE5 in accordance with IEC 60034-30-2.

The motor includes a frequency converter and PI controller in the motor terminal box. This enables continuously variable control of the motor speed, which again enables adaptation of the performance to a given requirement.

An operating panel on the motor terminal box enables setting of required setpoint as well as setting of pump to "Min." or "Max." operation or to "Stop". The Grundfos Eye indicator on the operating panel provides visual indication of pump status:

- "Power on": Motor is running (rotating green indicator lights) or not running (permanently green indicator lights)
- "Warning": Motor is still running (rotating yellow indicator lights) or has stopped (permanently yellow indicator lights)
- "Alarm": Motor has stopped (flashing red indicator lights).

Communication with the pump is possible by means of Grundfos GO Remote (accessory). The remote control enables further settings as well as reading out of a number of parameters such as "Actual value", "Speed", "Power input" and total "Power consumption".

The terminal box holds terminals for these connections:

- one dedicated digital input
- two analog inputs, 0(4)-20 mA, 0-5 V, 0-10 V, 0.5 - 3.5 V
- 5 V voltage supply to potentiometer and sensor
- one configurable digital input or open-collector output
- Grundfos Digital Sensor input and output
- 24 V voltage supply for sensors
- two signal-relay outputs (potential-free contacts)
- GENIbus connection
- interface for Grundfos CIM fieldbus module.

Controls:

Frequency converter: Built-in

Liquid:

Pumped liquid: Water

Liquid temperature range: -20 .. 120 °C

Selected liquid temperature: 20 °C

Density at selected liquid temperature: 998.2 kg/m³**Technical:**

Qty.	Description
	<p>Pump speed on which pump data are based: 3480 rpm</p> <p>Rated flow: 3.72 m³/h</p> <p>Rated head: 29.27 m</p> <p>Code for shaft seal: AQQE</p> <p>Curve tolerance: ISO9906:2012 3B</p> <p>Materials:</p> <p>Pump housing: Stainless steel EN 1.4301 AISI 304</p> <p>Impeller: Stainless steel EN 1.4301 AISI 304</p> <p>Installation:</p> <p>Range of ambient temperature: -20 .. 40 °C</p> <p>Maximum operating pressure: 16 bar</p> <p>Max pressure at stated temp: 16 bar / 90 °C 10 bar / 120 °C</p> <p>Type of connection: Rp</p> <p>Size of inlet connection: 1 inch</p> <p>Size of outlet connection: 1 inch</p> <p>Outlet position: 12</p> <p>Electrical data:</p> <p>Motor standard: IEC</p> <p>Frame size: 80B</p> <p>IE efficiency class: IE5</p> <p>Rated power - P2: 1.1 kW</p> <p>Mains frequency: 50 Hz</p> <p>Rated voltage: 1 x 200-240 V</p> <p>Rated current: 6.70-5.60 A</p> <p>Rated speed: 360-4000 rpm</p> <p>Enclosure class (IEC 34-5): IP55</p> <p>Insulation class (IEC 85): F</p> <p>Others:</p> <p>Terminal box position: 12</p> <p>Minimum efficiency index, MEI : 0.7</p> <p>Net weight: 15.2 kg</p> <p>Gross weight: 18.7 kg</p> <p>Danish VVS No.: 385231030</p> <p>Approvals: CE,WRAS,ACS,TR,EAC</p> <p>Country of origin: HU</p> <p>Custom tariff no.: 84137075</p>

98394972 CME 3-3 A-R-I-E-AQQE U-A-D-N 50 Hz

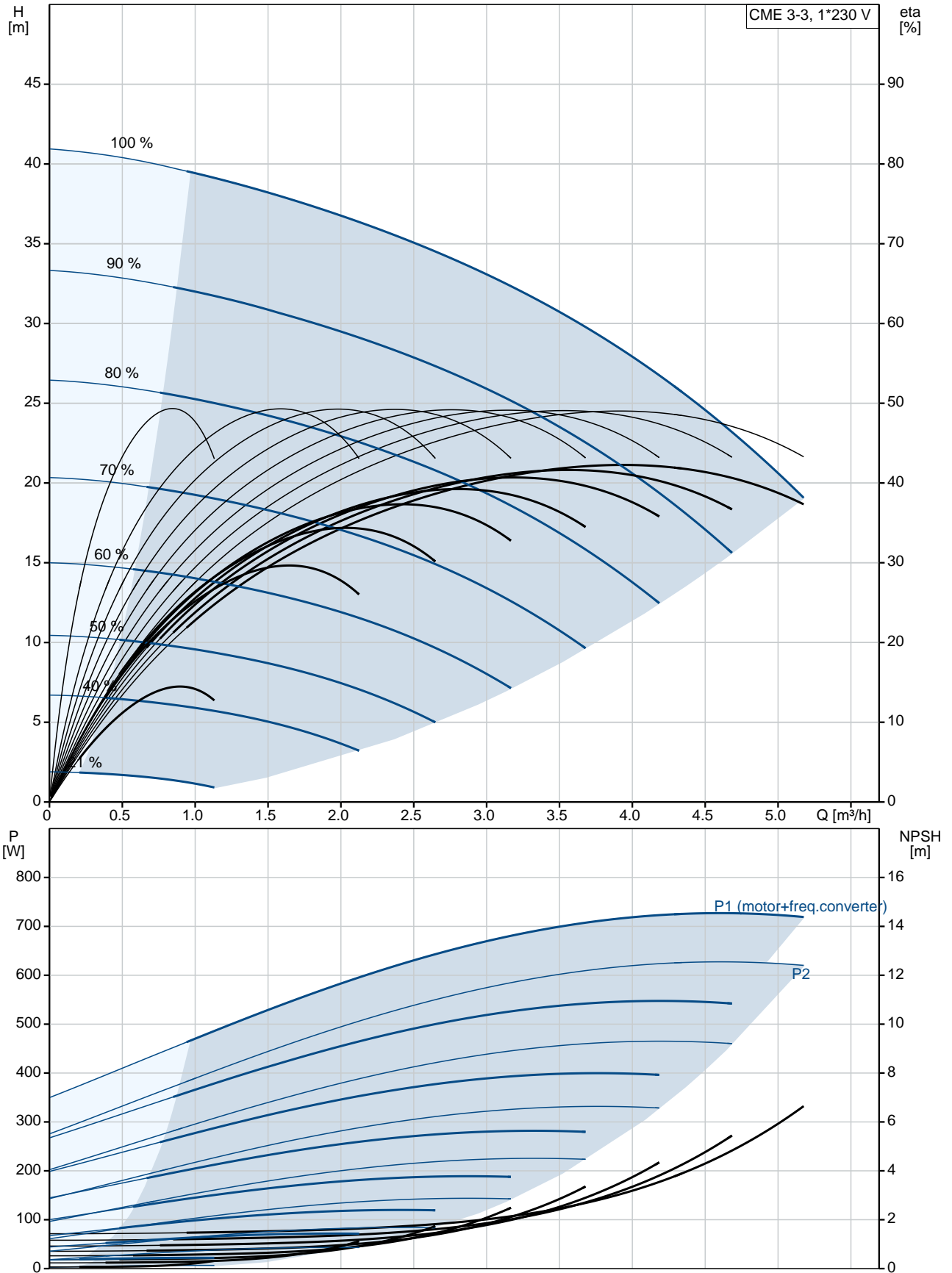

Description	Value
General information:	
Product name:	CME 3-3 A-R-I-E-AQQE U-A-D-N
Product No:	98394972
EAN number:	5711494281497
	5711494281497
Price:	1.103,00 GBP
Technical:	
Pump speed on which pump data are based:	3480 rpm
Rated flow:	3.72 m³/h
Rated head:	29.27 m
Impellers:	3
Code for shaft seal:	AQQE
Curve tolerance:	ISO9906:2012 3B
Pump version:	A
Model:	A
Materials:	
Pump housing:	Stainless steel
	EN 1.4301
	AISI 304
Impeller:	Stainless steel
	EN 1.4301
	AISI 304
Material code:	I
Code for rubber:	E
Installation:	
Range of ambient temperature:	-20 .. 40 °C
Maximum operating pressure:	16 bar
Max pressure at stated temp:	16 bar / 90 °C
	10 bar / 120 °C
Type of connection:	Rp
Size of inlet connection:	1 inch
Size of outlet connection:	1 inch
Outlet position:	12
Connect code:	R
Liquid:	
Pumped liquid:	Water
Liquid temperature range:	-20 .. 120 °C
Selected liquid temperature:	20 °C
Density at selected liquid temperature:	998.2 kg/m³
Electrical data:	
Motor standard:	IEC
Frame size:	80B
IE efficiency class:	IE5
Rated power - P2:	1.1 kW
Mains frequency:	50 Hz
Rated voltage:	1 x 200-240 V
Rated current:	6.70-5.60 A
Rated speed:	360-4000 rpm
Enclosure class (IEC 34-5):	IP55
Insulation class (IEC 85):	F
Controls:	
Frequency converter:	Built-in
Others:	
Terminal box position:	12
Minimum efficiency index, MEI :	0.7
Net weight:	15.2 kg

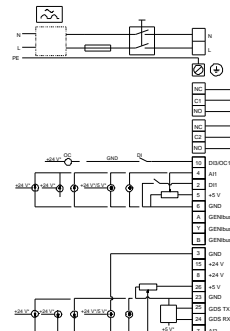
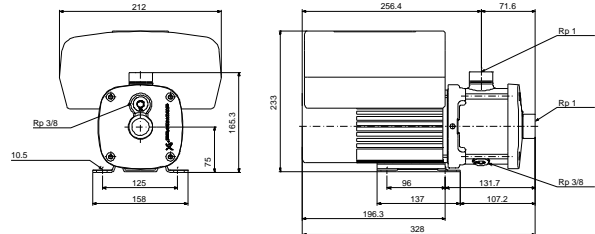
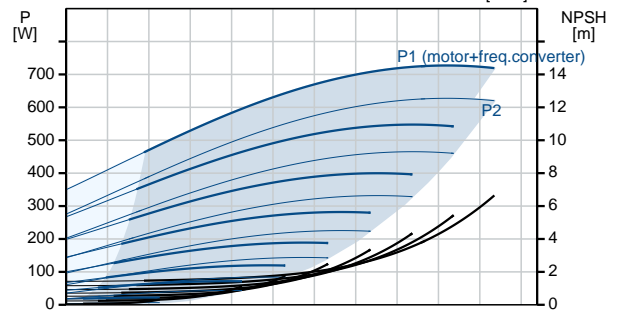
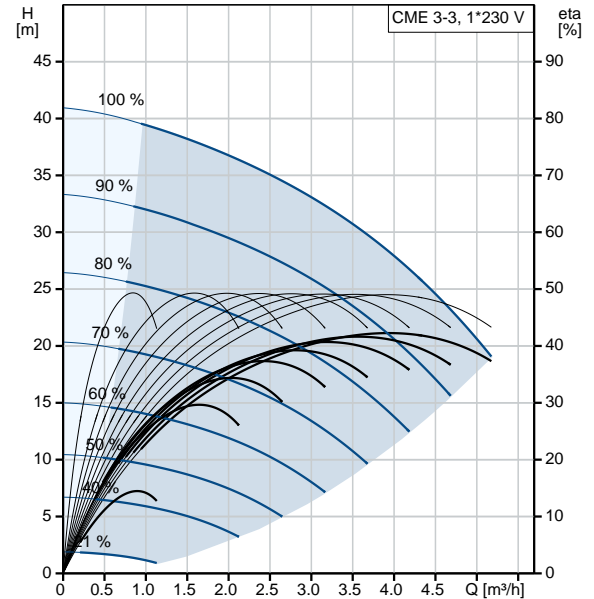



Company name:

Created by:

Phone:

Date:

25/09/2019

Description	Value
Gross weight:	18.7 kg
Danish VVS No.:	385231030
Approvals:	CE,WRAS,ACS,TR,EAC
Country of origin:	HU
Custom tariff no.:	84137075

98394972 CME 3-3 A-R-I-E-AQQE U-A-D-N 50 Hz

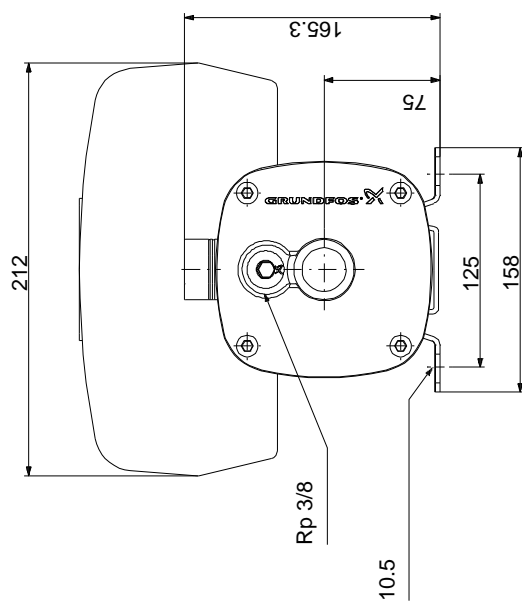
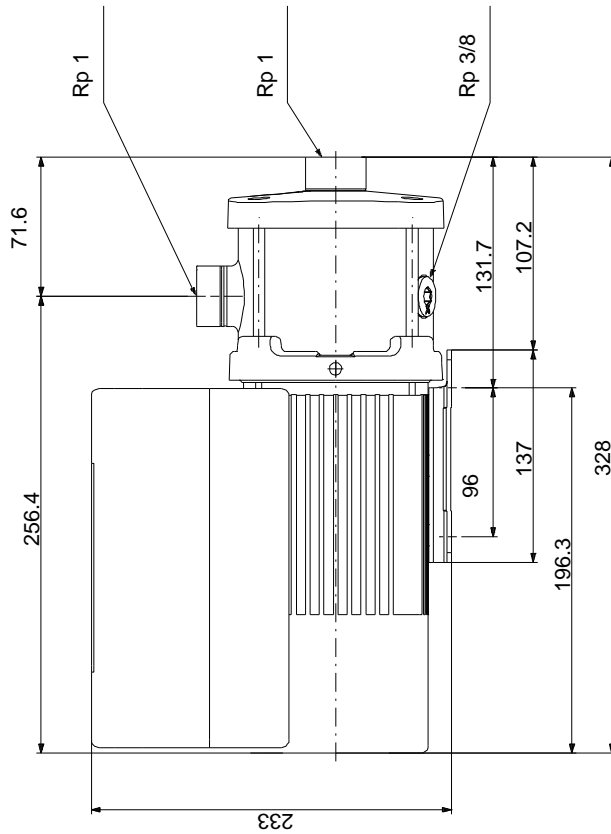

Note! All units are in [mm] unless others are stated.
Disclaimer: This simplified dimensional drawing does not show all details.

98394972 CME 3-3 A-R-I-E-AQQE U-A-D-N 50 Hz

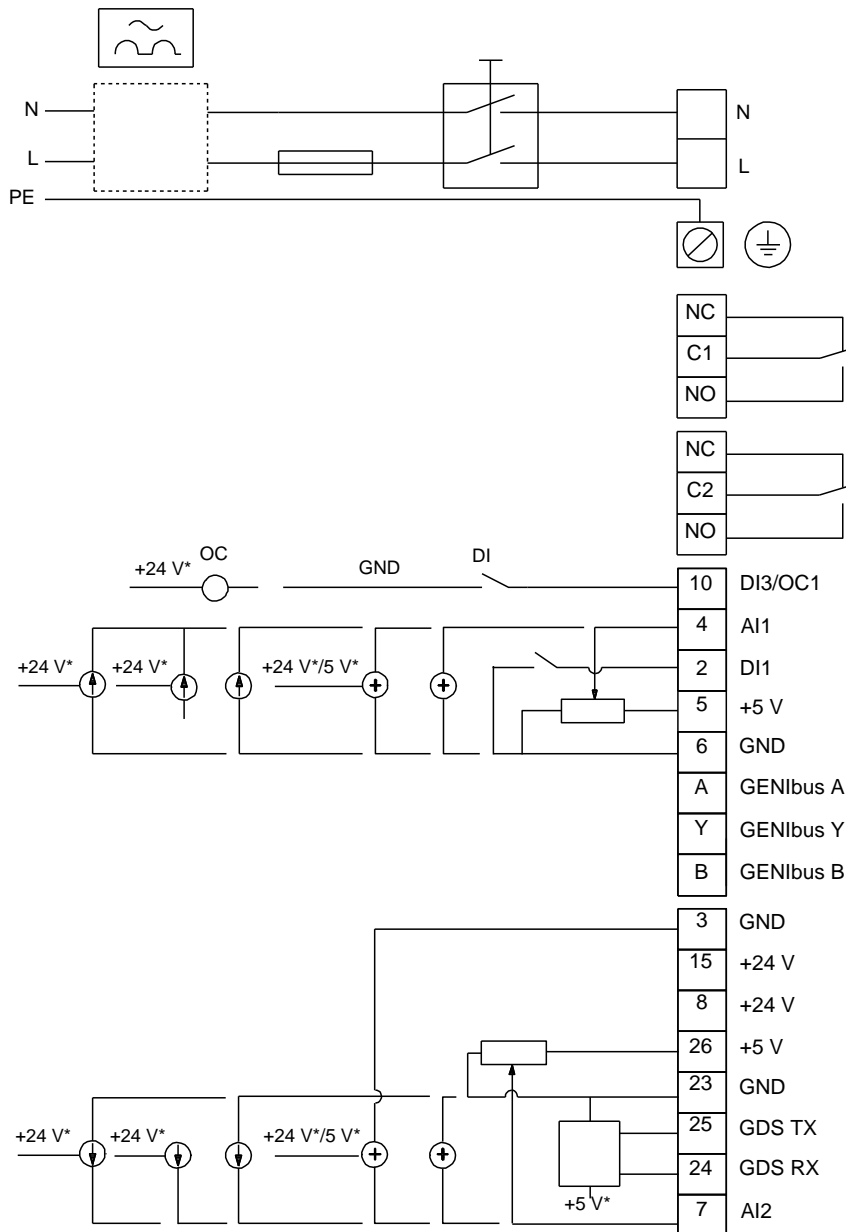

Note! All units are in [mm] unless others are stated.