

**Qty. Description**

1 **Hydro MPC-E 3 CRIE5-9**



Note! Product picture may differ from actual product

Product No.: [98426918](#)

Pressure booster system supplied as compact assembly according to DIN standard 1988/T5.

All pumps are speed-controlled.

From 0.37 to 11 kW, the booster system is equipped with CR, CRE, CRI, CRIE pumps with electronically commutated permanent-magnet motors with extremely high efficiency. The total efficiency of the motor including the frequency converter applies to IE5 level in IEC60034-31.

From 15 to 22 kW, the booster system is equipped with CR, CRE, CRI, CRIE pumps with motors with integrated frequency control. The total efficiency of the motor including the frequency converter is better than the IE3 level in IEC60034-31, even though this standard only applies to the motor.

- \* Hydro MPC-E maintains a constant pressure through continuous adjustment of the speed of the pumps.
- \* The system performance is adapted to the demand through cutting in/out the required number of pumps and through parallel control of the pumps in operation.
- \* Pump changeover is automatic and depends on load, time and fault.

The system consists of these parts:

Pump parts in contact with the pumped liquid are made of stainless steel EN DIN 1.4301

Pump bases and heads are of either cast iron/stainless steel (CRI) or cast iron EN-GJS-500-7 (CR), depending on pump type; other vital parts are made of stainless steel EN DIN 1.4301

The pumps are equipped with a service-friendly cartridge shaft seal, HQQE (SiC/SiC/EPDM)

- \* Two stainless steel manifolds to EN DIN 1.4571
- \* Stainless steel base frame to EN DIN 1.4301 up to CR 90; above CR 90 the pumps are placed on a galvanized I-Beam frame
- \* One non-return valve (POM) and two isolating valves for each pump
- \* Non-return valves are certified according to DVGW, isolating valves according to DIN and DVGW
- \* Adapter with isolating valve for connection of diaphragm tank
- \* Pressure gauge and pressure transmitter (analog output 4-20 mA)
- \* Control MPC in a steel cabinet, IP54, including main switch, all required fuses, motor protection, switching equipment and microprocessor-controlled CU 352.

Dry-running protection and diaphragm tank are available according to the list of accessories.

Pump operation is controlled by Control MPC with the following functions:

- \* Intelligent multipump controller, CU 352.
- Constant-pressure control through continuously variable adjustment of the speed of each individual pump.
- PID controller with adjustable PI parameters ( $K_p + T_i$ ).
- Constant pressure at setpoint, independent of inlet pressure.
- Soft pressure build-up (To prevent water hammer during startup).
- On/off operation at low flow.
- Automatic cascade control of pumps for optimum efficiency.
- Selection of min. time between start/stop, automatic pump changeover and pump priority.
- Automatic pump test function to prevent idle pumps from seizing up.
- Possibility of standby pump allocation.
- Possibility of backup sensor (redundant primary sensor).

Qty.	Description
	<p>Secondary sensor (Possible to switch to another sensor/setpoint).            Multi-sensor (up to 6 sensors to influence the setpoint).            Manual operation.            Possibility of external setpoint influence.            Log function.            Setpoint ramp.            Possibility of digital remote-control functions:            System on/off.            Max., min. or user-defined duty.            Up to 6 alternative setpoints.            Digital inputs and outputs can be configured individually.            Pump and system monitoring functions:            Minimum and maximum limits of current value.            Inlet pressure.            Non-return valve monitoring.            Motor protection.            Sensors and cables monitored for malfunction.            Alarm log with the previous 24 warnings/alarms.            Display and indication functions:            Colour screen display.            Green indicator light for operating indications and red indicator light for fault indications            Potential-free changeover contacts for operation and fault.            Grundfos bus communication.</p> <p>It is possible to add CIM communication modules for communicating with Scada/BMS.</p> <p>Pumps, piping, cabling complete as well as Control MPC are mounted on the base frame.            The booster system has been preset and tested.</p> <p>Flow media: Water            Allowed liquid temp.: 5 °C .. 60 °C            System pressure max.: 16 bar            Flow (Plant): 31 m<sup>3</sup>/h            Flow without one stand-by pump acc. DIN 1988/T5: 20 m<sup>3</sup>/h            Mains suply: 380-415 V            Nom. current of plant: 15,0A-415V            Nominal power: 2.2 kW            Net weight: 153 kg</p> <p>Maximum head: 93 m            Maximum flow: 31 m<sup>3</sup>/h</p>

## 98426918 Hydro MPC-E 3 CRIE5-9 50 Hz

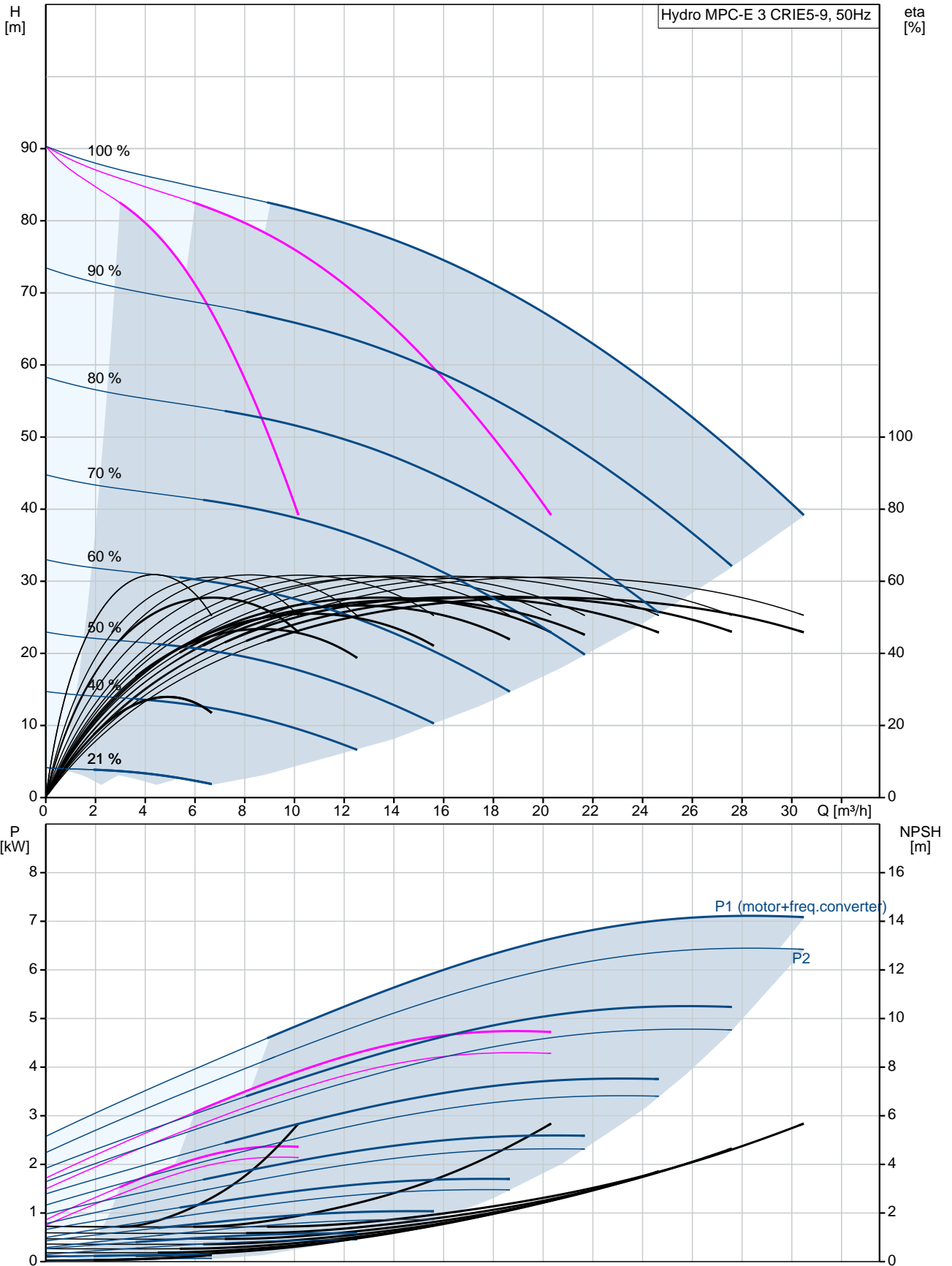

Description	Value
<b>General information:</b>	
Product name:	Hydro MPC-E 3 CRIE5-9
Product No:	98426918
EAN number:	5711494818228
	5711494818228
<b>Technical:</b>	
Max flow:	31 m <sup>3</sup> /h
Max flow system:	20 m <sup>3</sup> /h
Head max:	93 m
Main pump name:	CRIE5-9
Main pump No:	98390070
Number of pumps:	3
Non-ret. valve:	at discharge side
<b>Materials:</b>	
Manifolds:	EN/DIN 1.4571/ AISI 316 TI
<b>Installation:</b>	
Maximum operating pressure:	16 bar
Maximum permissible inlet pressure:	12.2 bar
Manifold inlet:	R 2"
Manifold outlet:	R 2"
Pressure rating:	PN16
Earth connection:	PE
<b>Liquid:</b>	
Pumped liquid:	Water
Liquid temperature range:	5 .. 60 °C
Selected liquid temperature:	20 °C
Density at selected liquid temperature:	998.2 kg/m <sup>3</sup>
<b>Electrical data:</b>	
Power (P2) main pump:	2.2 kW
Mains frequency:	50 Hz
Rated voltage:	3 x 380-415 V
Rated current of system:	15,0A-415V
Start. method:	electronically
Enclosure class (IEC 34-5):	IP54
Radio interference supression:	EMC DIRECTIVE(2014/30/EU)
<b>Controls:</b>	
Control type:	E
<b>Tank:</b>	
Diaphragm tank:	Yes
<b>Others:</b>	
Basis plant:	Y
Net weight:	153 kg
Gross weight:	173 kg
Product range:	GB
Config. file no:	98272377
Config.file Control MPC:	98271947
Config.file Hydro MPC:	98272020
Country of origin:	GB
Custom tariff no.:	84137075

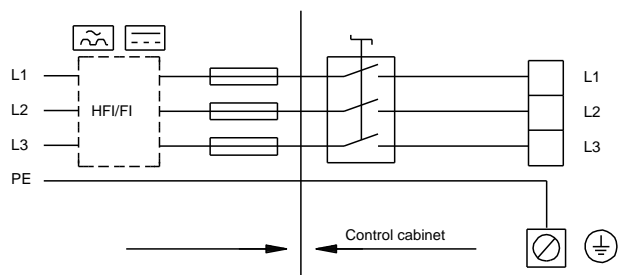
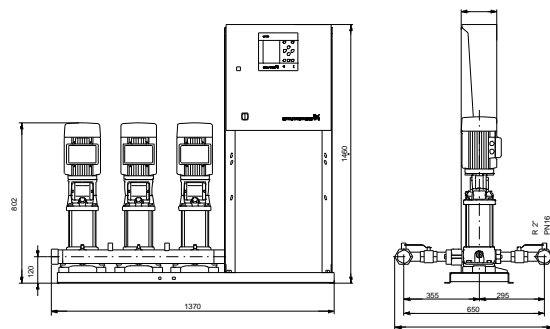
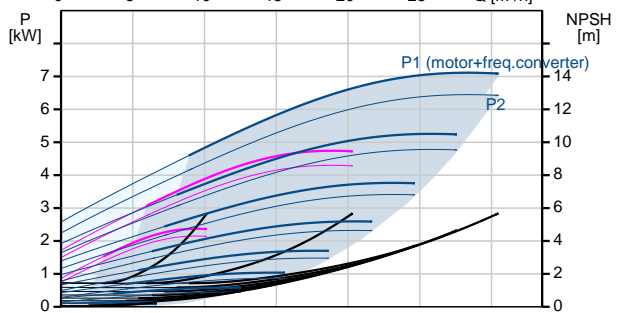
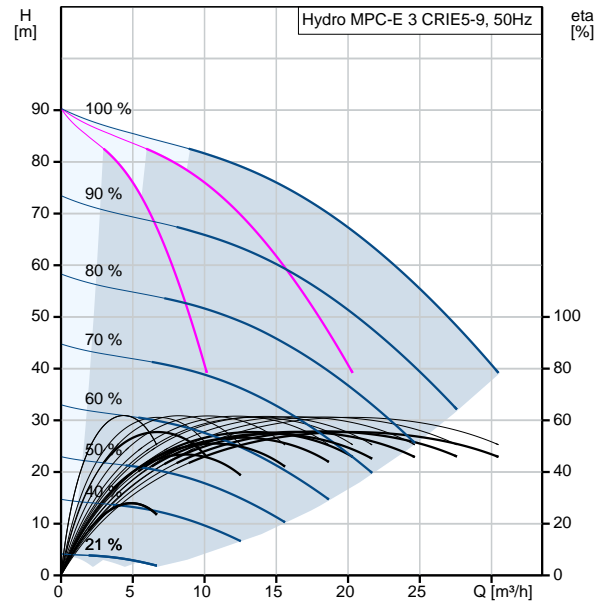

## 98426918 Hydro MPC-E 3 CRIE5-9 50 Hz

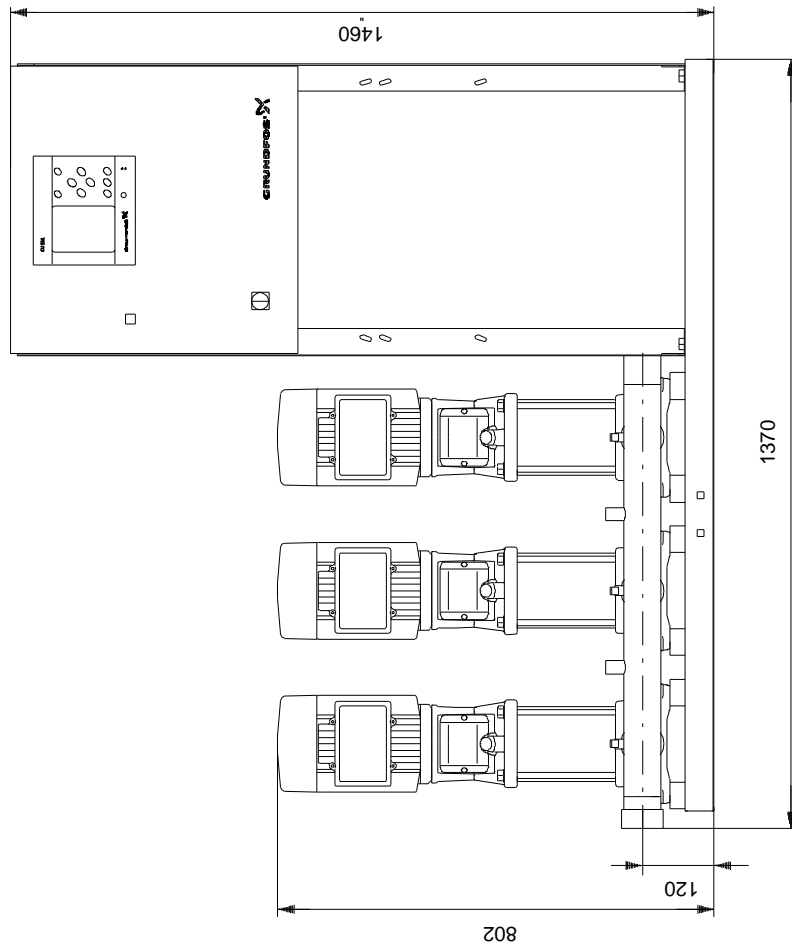
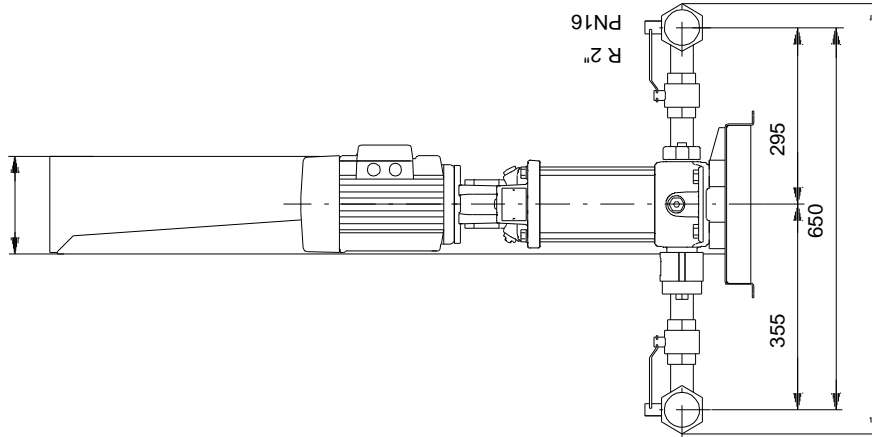

Note! All units are in [mm] unless others are stated.  
Disclaimer: This simplified dimensional drawing does not show all details.

## 98426918 Hydro MPC-E 3 CRIE5-9 50 Hz

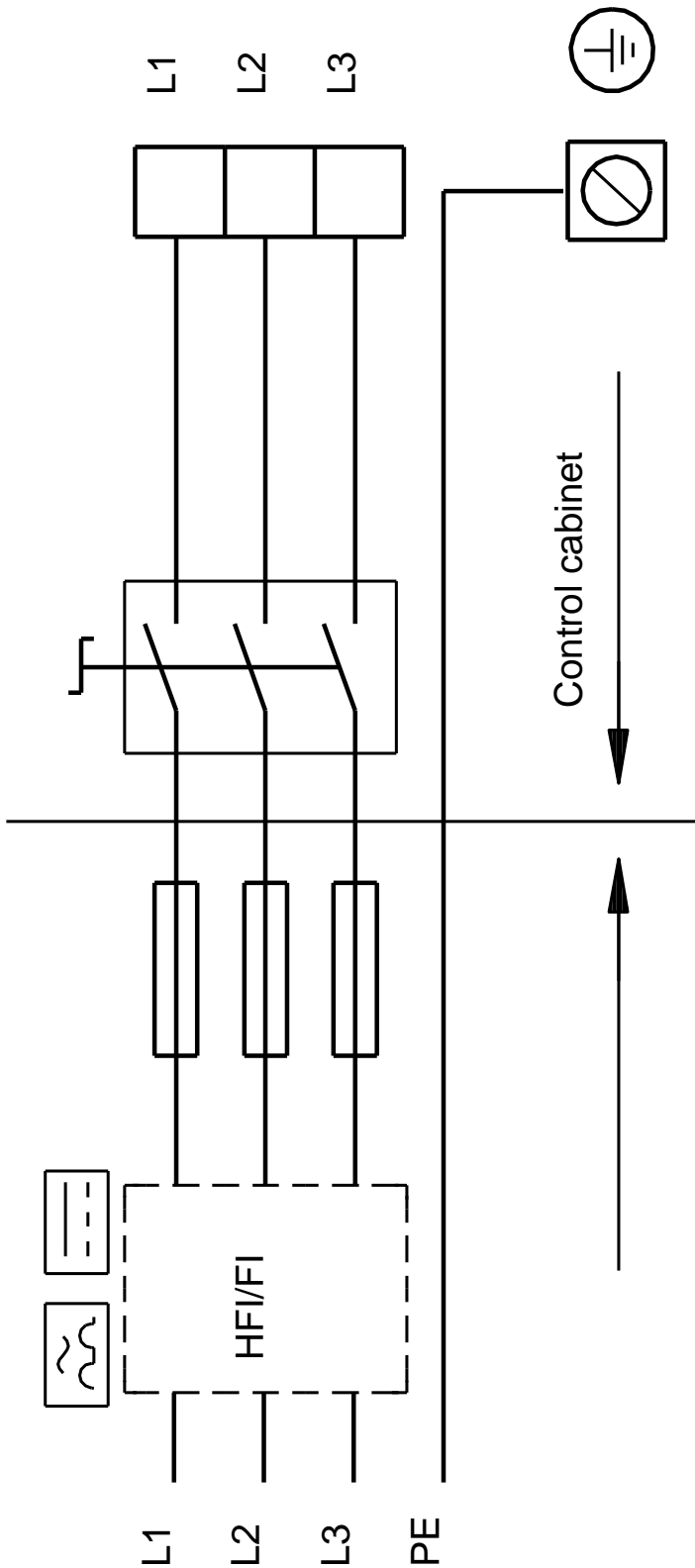

Note! All units are in [mm] unless others are stated.