

# PRO-C<sup>®</sup>

RESIDENTIAL AND LIGHT COMMERCIAL  
IRRIGATION CONTROLLER

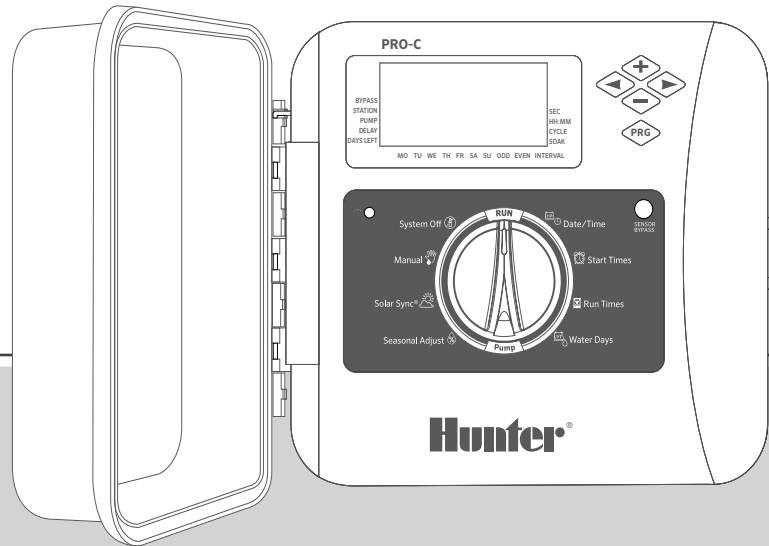

## P2C Series

Modular Controller  
Indoor/Outdoor

Owner's Manual  
Installation Instructions

# Hunter<sup>®</sup>

# Table of Contents

---

<b>3</b>	Specifications	<b>15</b>	Connecting to a Hunter Solar Sync® Sensor
<b>4</b>	Pro-C Controller Components	<b>16</b>	Setting the Current Date and Time
<b>6</b>	Mounting the Controller to a Wall	<b>17</b>	Setting Program Start Times
<b>7</b>	Connecting AC Power	<b>18</b>	Setting Station Run Times
<b>8</b>	Installing Station Modules	<b>19</b>	Setting a Watering Schedule
<b>9</b>	Connecting Station Wires	<b>21</b>	Options for Running Your Irrigation System
<b>10</b>	Connecting a Master Valve	<b>24</b>	Hidden and Advanced Features
<b>11</b>	Connecting a Pump Start Relay (optional)	<b>25</b>	Troubleshooting Guide
<b>12</b>	Connecting a Hunter CliK Weather Sensor (not included)	<b>26</b>	FCC Notice
<b>14</b>	Connecting a Hunter Remote (not included)		

**Need more helpful information on your product?**  
**Find tips on installation, controller programming, and more.**



[hunter.help/Pro2C](https://hunter.help/Pro2C)

## Operating Specifications

- **Station Count:** Conventional wiring from 4 to 23 stations, two-wire EZ Decoder System option up to 32 stations
- **Station Run Time:** 1 minute to 6 hours (optional Seconds Mode, see pg. 18)
- **Start Times:** 4 individual starts per program, three programs available (A, B, C)
- **Watering Schedule:** 7-day calendar, interval watering up to a 31-day interval or true odd or even day programming

## Electrical Specifications

- **Transformer Input:** 120 VAC, 60 Hz (230 VAC, 50/60 Hz for international use)
- **Transformer Output:** 24 VAC, 1 A
- **Station Output:** 24 VAC, 0.56 A per station
- **P/MV Output:** 24 VAC, 0.28 A
- **Maximum Output:** 24 VAC, 0.84 A (includes Master Valve Circuit)
- **Battery:** 9 V alkaline battery (not included) used only for non-AC programming of the control panel
- Battery, front panel, internal CR2032 lithium for real-time clock

## Cabinet Dimensions

- Height: 9" (23 cm)  
Width: 10" (21.5 cm)  
Depth: 4½" (10.9 cm)
- Cabinet is NEMA 3R, IP44 rated

## Default Settings

All stations are set to zero run time. This controller has a non-volatile memory that retains all entered program data, even during power outages, without need for a battery.

# Pro-C Controller Components

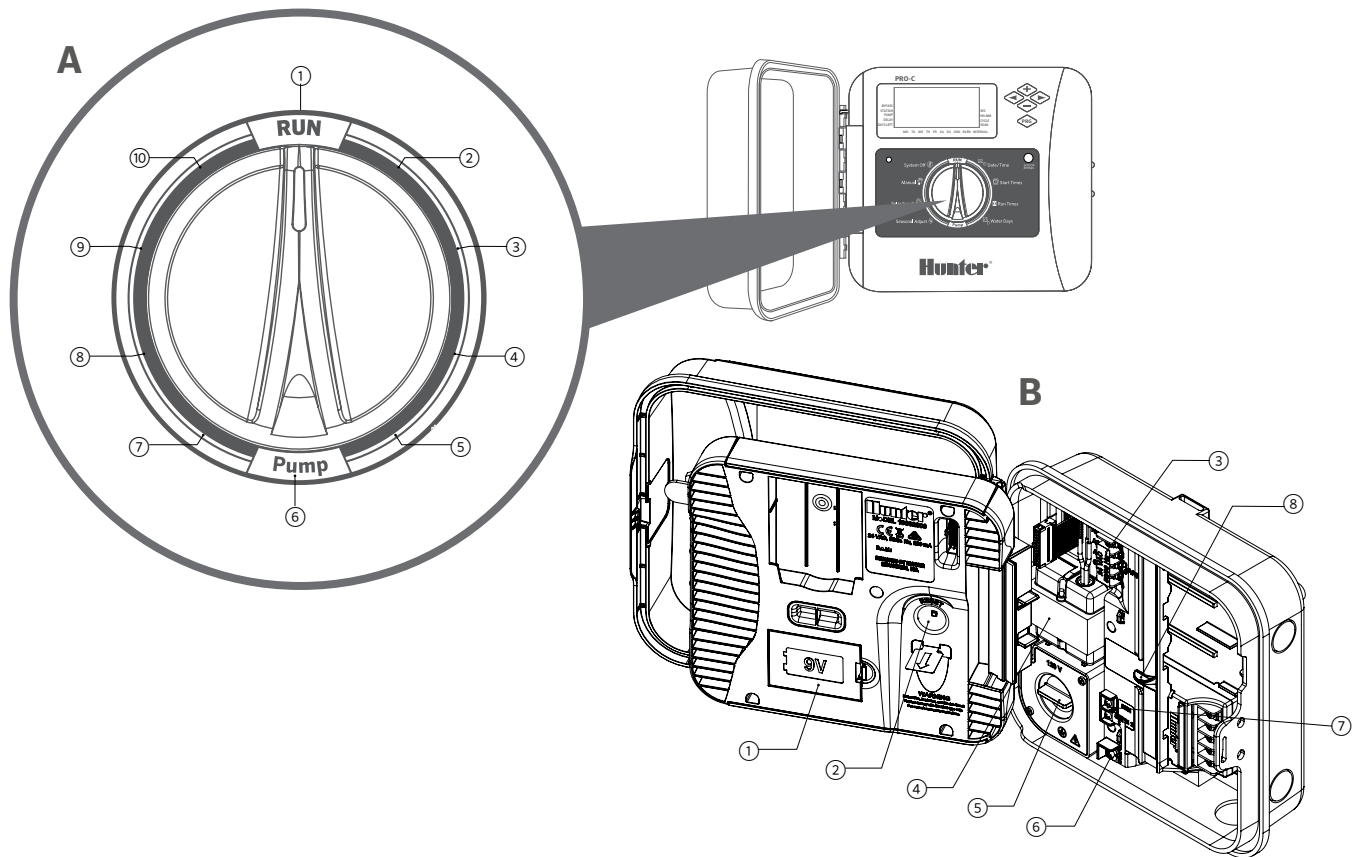

## A Control Dial

①	<b>Run</b>	Normal dial position for automatic operation
②	<b>Set Date/Time</b>	Set current date and time
③	<b>Set Program Start Times</b>	Set 1 to 4 start times in each program
④	<b>Set Station Run Times</b>	Set run time for each station
⑤	<b>Set Days to Water</b>	Select individual days to water, odd, even, or interval watering schedule
⑥	<b>Set P/MV Operation</b>	Enable or disable the Pump or Master Valve for each station
⑦	<b>Seasonal Adjustment</b>	Apply global adjustments to station run times based on seasonality (5% to 300%)
⑧	<b>Solar Sync® Sensor</b>	Allows user to program settings when using Solar Sync ET Sensor
⑨	<b>Manual — Single Station</b>	Activates one-time watering of a single station

## B Wiring Compartment

①	<b>9 V Battery</b>	An alkaline battery (not included) allows programming of the controller facepack without AC power
②	<b>Reset Button</b>	Resets the controller, keeping all programmed data intact
③	<b>SmartPort® Input Terminals</b>	Used to connect a SmartPort Wiring Harness, which enables Hunter remote controls
④	<b>Transformer</b>	Internal 24 VAC transformer, prewired with power cord and plug
⑤	<b>Junction Box</b>	Wiring compartment that provides an area for connecting primary AC power to the controller
⑥	<b>Common Terminal</b>	Used for field Common connections to solenoid valves; also used to complete sensor circuit wiring
⑦	<b>Sensor Inputs (x 2)</b>	Used to connect Hunter Solar Sync and Klik Sensors
⑧	<b>Power Slide</b>	Slide power lock On and Off when inserting and removing PCM output modules

## Mounting the Controller to a Wall

### All necessary hardware is included for indoor and outdoor installations.

1. Use the hole at the top of the controller as a reference and secure a 1" (25 mm) screw into the wall. **Note: Install screw anchors if attaching to drywall or masonry wall.**
2. Align controller with the screw and slide the keyhole on top of the controller over the screw.
3. Secure controller in place by installing screws in the holes.



#### Note

Outdoor model is water- and weather-resistant. Connecting the outdoor Pro-C Controller to the primary power should be done by a licensed electrician following all local codes. Improper installation could result in shock or fire hazard. This device is not intended for use by young children. Never let children play with this device.

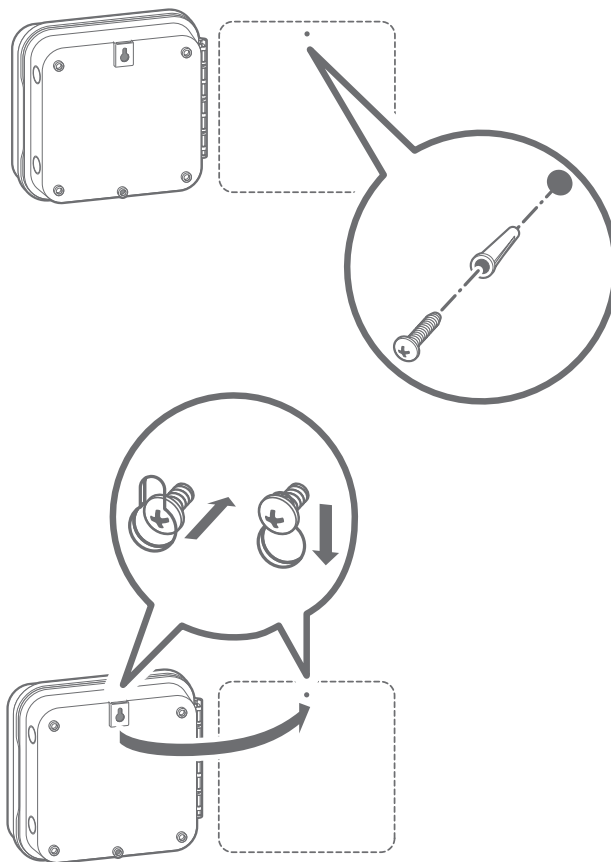

## Outdoor Cabinet

P2C models are prewired with a power cord and plug for simple installations in both indoor and outdoor applications. If the controller is to be powered by direct line voltage, follow these wiring instructions:

1. Route **AC** power cable and conduit through the  $\frac{1}{2}$ " (13 mm) conduit opening on the left side of the cabinet bottom.
2. Connect the wires to the transformer wires located inside the junction box. Always use a UL Listed conduit  $\frac{1}{2}$ " (13 mm) male adapter when installing the **AC** wiring.
3. Insert the adapter into the  $\frac{1}{2}$ " (13 mm) hole at the bottom of the controller. Attach a nut to the adapter inside the enclosure.

- ① **GROUND**  
(Green)
- ② **NEUTRAL**  
(White)
- ③ **HOT**  
(Black)

Outdoor Cabinet

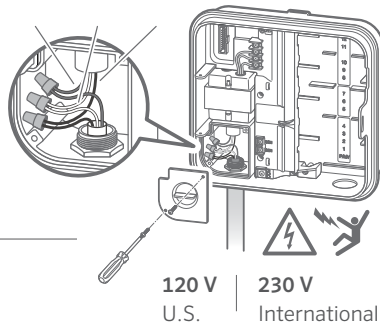

**To be performed by a licensed electrician only.**

Always use UL Listed  $\frac{1}{2}$ " (13 mm) conduit with male adapter when installing AC wiring. Pro-C Controllers are intended to be supplied AC power with a 15 A rated overcurrent protected device.

## Installing Station Modules

The Pro-C Controller is supplied with a factory-installed base module for up to 4 stations. Additional modules may be added in increments of 3 stations (PCM-300), 9 stations (PCM-900), or 16 stations (PCM-1600). In total, a conventionally wired system can be expanded up to 23 stations. Additional modules are sold separately.

The Pro-C Controller is also compatible with the EZ Decoder System (EZDS) for hybrid conventional and two-wire operations. Add a Pro-C Decoder Module (PC-DM) to enable control for up to 32 total stations. This system uses the same EZ-1 Decoders used with ICC2, HCC, and HPC Controllers. For more installation and programming details, please refer to the PC-DM Installation Guide.



[hunter.info/P2CDecoder](http://hunter.info/P2CDecoder)

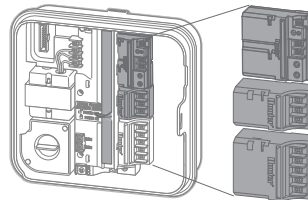
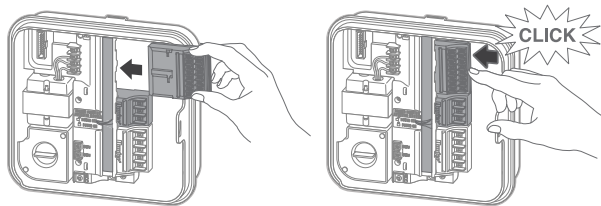

## Installing PCM Modules

The Pro-C Controller is designed with a simple-to-use **Power Lock** feature that ensures the modules are energized and firmly secured into the controller. The **Power Lock** can unlock or lock all modules at the same time by simply pushing the **Power Lock** slide.

1. Slide the **Power Lock** into the **Power Off** (unlocked) position. Insert the PCM modules into the appropriate sequential position in the controller cabinet.
2. Once all of the modules are in place, slide the **Power Lock** into the **Power On** (locked) position to energize and secure the modules into the controller.
3. The Pro-C Controller will automatically recognize the correct number of stations. It is not necessary to press the reset button on the back of the facepack or cycle power to the controller.



1. Route valve wires between control valve location and controller.
2. At valves, attach a Common wire to either solenoid wire of all valves. This is most commonly a white wire. Attach a separate control wire to the remaining wire of each valve. All wire splice connections should be done using waterproof connectors.
3. Route valve wires through the conduit and attach the conduit to one of the openings on the cabinet bottom.
4. Strip  $\frac{1}{2}$ " (13 mm) of insulation from ends of all wires. Secure the valve Common wire to **COM** (Common) terminal. Attach all individual valve control wires to the appropriate station terminals.

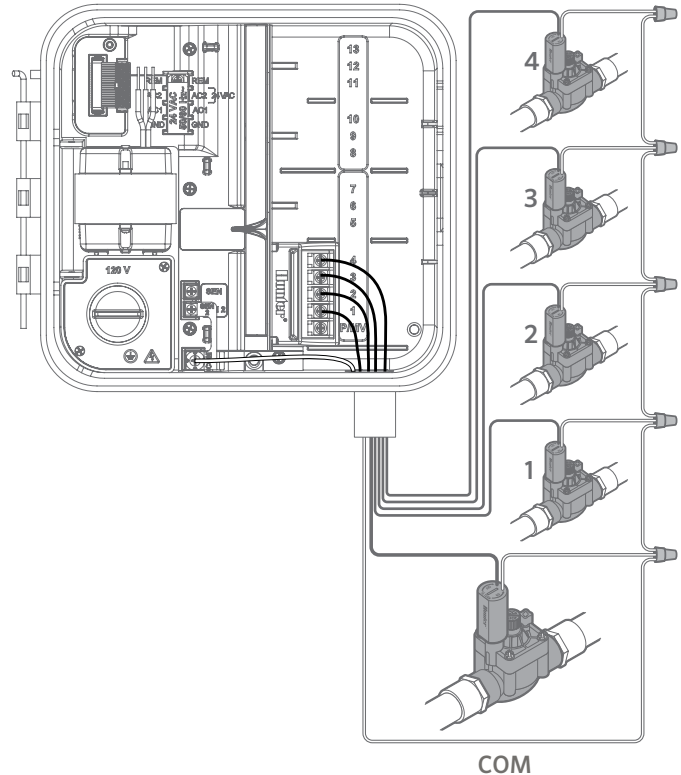

## Connecting a Master Valve

Connect either wire from the Master Valve to the **P/MV** terminal located on the bottom of the 4-station base module. Connect remaining wire to the **COM** (Common) terminal.

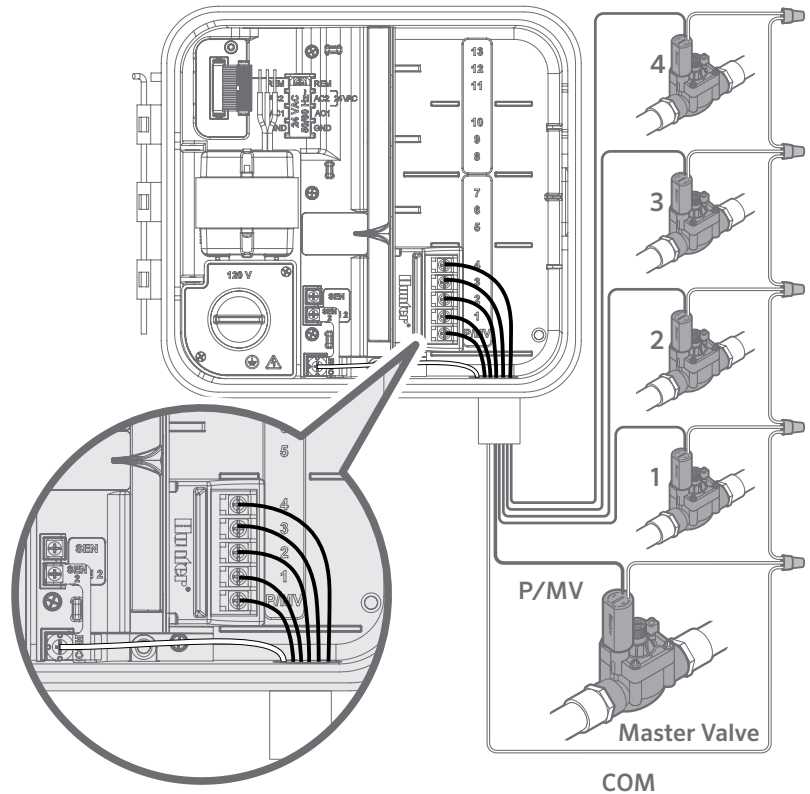

## Connecting a Pump Start Relay (optional)

1. Route a wire pair from the pump relay into the controller housing.
2. Connect the pump Common wire to the terminal slot **COM** (Common) and the remaining wire from the pump relay to the **P/MV** terminal slot on the 4-station base module.

The relay holding the current draw must not exceed 0.28 A (24 VAC). **Do not connect the controller directly to the pump — damage to the controller will result.**

For more information on the installation of a Pump Start Relay, visit the support page.



[hunter.help/PSR](https://hunter.help/PSR)

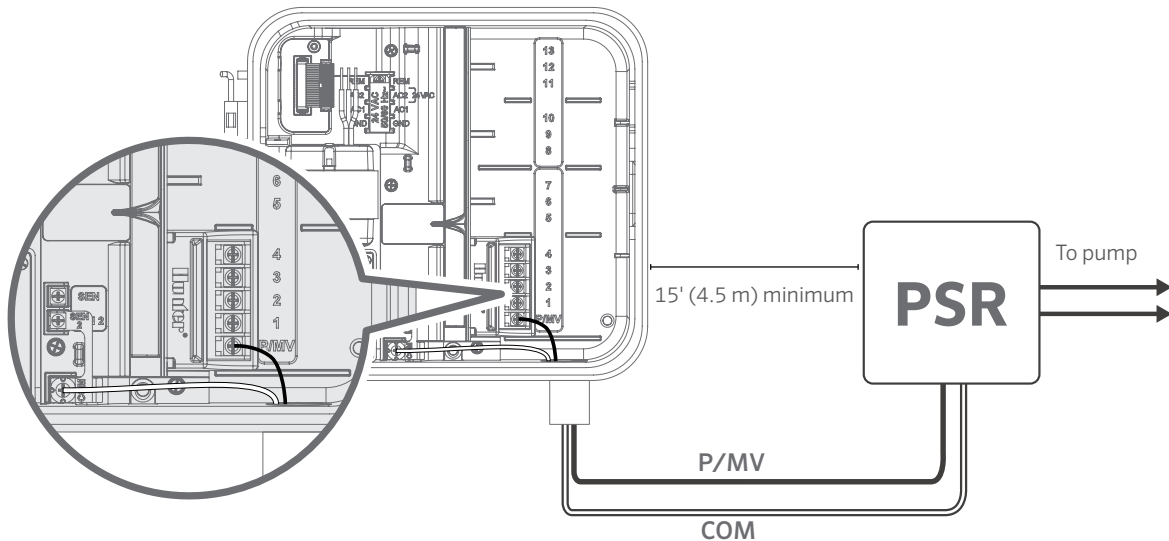

## Connecting a Hunter Clik Weather Sensor (not included)

A Hunter weather sensor or other micro-switch-type weather sensors can be connected to the Pro-C Controller. The purpose of this sensor is to stop automatic watering when weather conditions dictate.

1. Remove the metal jumper plate that is attached across **SEN-2** and **COM**.
2. Connect one wire from the sensor to the **SEN-2** screw terminal and the other sensor wire to the **COM** terminal.

When the weather sensor has deactivated automatic watering, **OFF** will appear on the display.

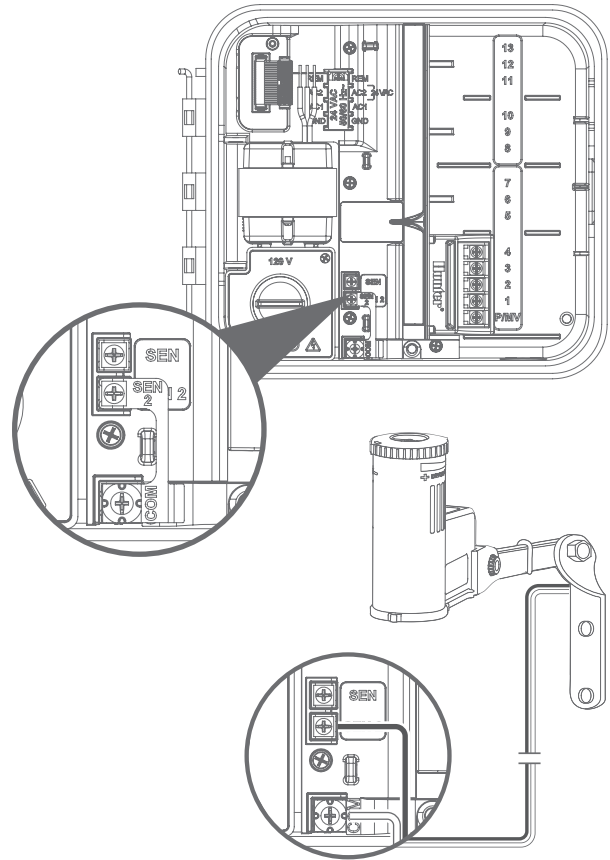

### Note

The Manual single-station function ignores any attached sensor and will allow watering to occur.

## Manually Bypassing the Weather Sensor

If the rain sensor is interrupting irrigation, you can bypass it by using the bypass switch on the front of the controller.

Press the Sensor Bypass button to temporarily bypass the sensor status and allow normal controller operation. **The Bypass switch will remain active for a maximum of 24 hours before reverting to active sensor status.** The Bypass indicator will be selected in the display when the Sensor Bypass switch is active. The Bypass switch does not affect the Seasonal Adjust update when using the Solar Sync Sensor.

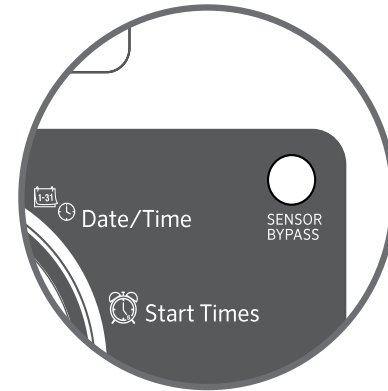

## Connecting a Hunter Remote (not included)

The Pro-C Controller is compatible with Hunter remote controls. The SmartPort Wiring Harness (included with all Hunter remotes) allows for fast and easy use of Hunter controls. Hunter remotes make it possible to operate the system without walking back and forth to the controller.

### Installing the SmartPort Connector

1. The SmartPort Connector can be installed directly on the cabinet via the side knockouts or in the electrical conduit connected to the controller.
2. Attach the **red** wire to the screw terminal marked **AC1**; attach the **white** wire to the screw terminal **AC2**; attach the **blue** wire to the screw terminal **REM**.

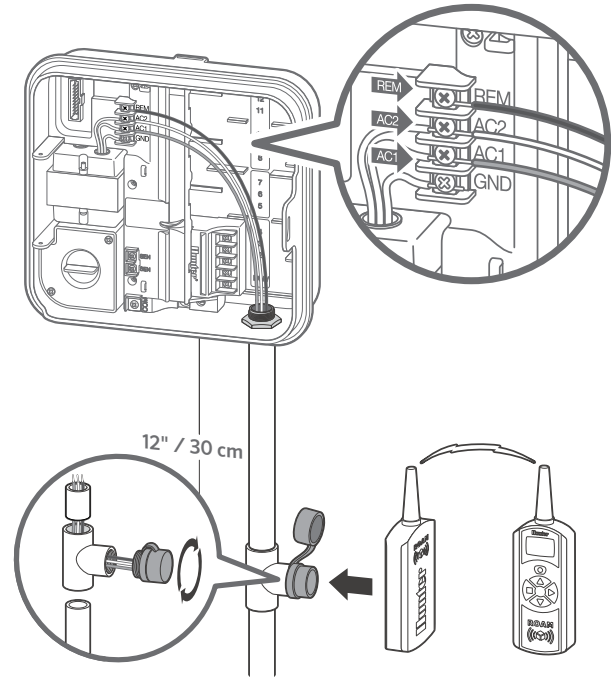

The Pro-C Controller can be made “smart” with the addition of a Solar Sync ET Sensor. This advanced weather sensor calculates daily evapotranspiration (ET) rates and adjusts irrigation schedules based on local weather conditions. In addition, the sensor includes automatic rain and freeze shutdown capabilities to prevent irrigation in raining or freezing conditions.

**The Solar Sync Sensor can only be wired to sensor terminal # 1 labeled SEN in the Pro-C Controller.** For additional Solar Sync installation and programming instructions, scan the QR code.



[hunter.info/SolarSyncSen](http://hunter.info/SolarSyncSen)

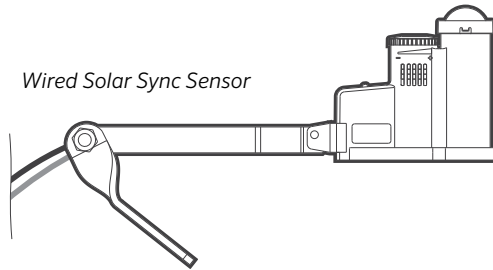

Wired Solar Sync Sensor

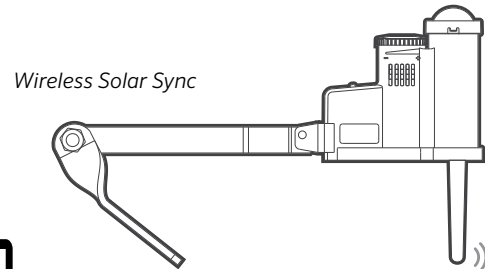

Wireless Solar Sync



Solar Sync Receiver

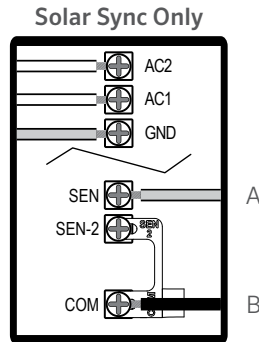

Green + Black to Solar Sync

### Solar Sync Wiring

WIRE COLOR	SENSOR TERMINAL
------------	-----------------

Green (A)	SEN
-----------	-----

Black (B)	COMMON
-----------	--------

*\*Do not remove jumper from SEN-2 to COM*

## Setting the Current Date and Time

1. Turn the dial to the **DATE/TIME** position.
2. The current year will flash in the display. Use the + and - buttons to change the year. Push the → button to set the month.
3. The month will flash. Use the + and - buttons to change the month. Press the → button to set the day.
4. The day will flash. Use the + and - buttons to change the day of the month. Press the → button to set the time.
5. The time will display. Use the + and - buttons to select AM, PM, or 24 hr. Press the → button to move to hours. Use the + and - buttons to change the hour shown on the display. Press the → button to move to minutes. Use the + and - buttons to change the minutes shown in the display.

The date and time have now been set.

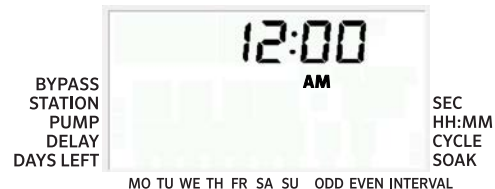



1. Turn the dial to the **START TIMES** position.
2. Press the **PRG** button to select **A**, **B**, or **C**.
3. Use the + and - buttons to change the start time. (Advances in 15-minute increments.) One start time will activate all stations sequentially in that program.
4. Press the → button to add another start time or the **PRG** button for the next program.

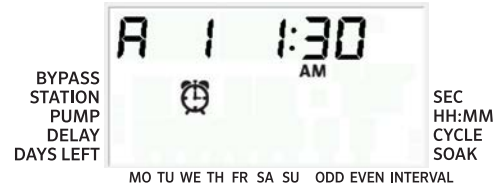

## Eliminating a Program Start Time

With the dial set to the **START TIMES** position, push the + and - buttons until you reach 12:00 am (midnight). From this position, push the - button once to reach the **OFF** position.

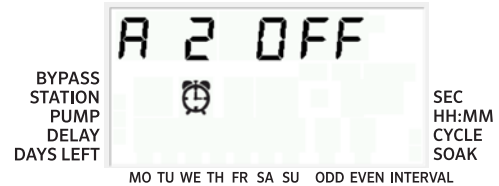

### Note

All stations operate in numerical order. Only one program start time is required to activate a watering program.

If a program has all four start times turned off, then that program is off (all other program details are retained). Because there are no start times, there will be no watering with that program.

# Setting Station Run Times

1. Turn the dial to the **RUN TIMES** position.
2. The display will show the last program selected (**A, B, or C**) and the station number selected. The run time for that station will flash. You can switch to another program by pressing the **PRG** button.
3. Use the + and - buttons to change the station run time on the display. You may set station run times from 1 minute to 6 hours.
4. Press the → button to advance to the next station.
5. Repeat steps 2 and 3 for each station.



## Run Times in Seconds Mode

Users can enable a **Seconds Mode** to input Station Run Times with seconds resolution. To select Seconds Mode:

1. With the dial set to Run, hold the + button while turning the dial to **Start Times**, then release the + button.
2. Press the + and - buttons to enable/disable Seconds Mode. The pointer indicator on the display will select **SEC** (for seconds) or **HH:MM** (for standard run times).
3. With the Seconds Mode enabled, turn the dial to the **Run Times** position and use the + and - buttons to increase and decrease run times for each station in 1-second intervals.
4. Users can set Run Times with seconds resolution up to 5 minutes. Any Run Time longer than 5 minutes will be set in 1-minute increments.

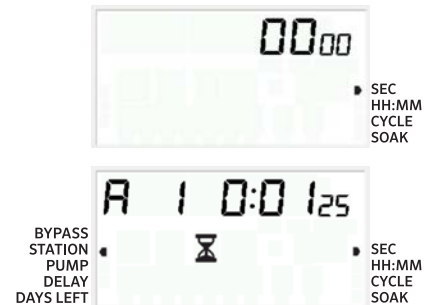

1. Turn the dial to the **WATER DAYS** position.
2. The display will show the last program selected (**A**, **B**, or **C**). You can switch to another program by pressing the **PRG** button.
3. The controller displays the active day schedule information. You can choose to water on specific days of the week, specific interval days, or odd/even days. Each program can operate using only one type of water day option.

## Selecting Specific Days of the Week to Water

1. Press the + button to activate a particular day of the week to water. Press the - button to cancel watering for that day. After pressing a button, the display automatically advances to the next day.
2. After programming, set the dial to the **RUN** position to enable automatic execution of all selected programs and start times.



## Selecting Odd or Even Days to Water

1. This feature uses numbered day(s) of the month for watering instead of specific days of the week (odd days: 1st, 3rd, 5th, etc.; even days: 2nd, 4th, 6th, etc.)
2. With the  cursor on **SU** in specific days of the week mode, press the → button once.
3. If even day watering is desired, press the - button once. **EVEN** will flash on the screen. You can move back and forth from **ODD** to **EVEN** by pressing the - button.
4. Once you selected odd or even day watering, turn the dial back to the **RUN TIMES** position.



 **Note**

The 31st of any month and February 29th are always **OFF** days if Odd day watering is selected.

## Setting a Watering Schedule (continued)

### Selecting Interval Watering

Use this feature to set a consistent irrigation schedule based on a number of days between watering, as opposed to specific days of the week.

1. Turn the dial to the **WATER DAYS** position. The water drop above Monday should flash.
2. Press the → button until **EVEN** days are selected, then press the → button one more time. The display will change to the interval mode and the Interval Day number will flash.
3. The display will now show two numbers: the interval and the days remaining in the interval.
4. The number of days between waterings, or the interval, will flash. Use the + and - buttons to select the number of days desired between waterings.
5. Press the → button. The days remaining in the interval are now flashing. Use the + and - buttons to select the number of days until the next desired watering. One day remaining means it will water the next day.
6. After setting the interval remaining days, press the → button to select non-water days (optional). Press the ← and → buttons to select specific days, and press the - button to designate as a non-water day.



#### Note

If any days are selected as non-water days at the bottom of the display, the Interval Day watering will exclude those days. For example, if the Interval Days are set at 5 and Monday is a non-water day, the controller will water every 5th day, but never on a Monday. If the interval water day falls on a Monday and Monday is a non-water day, the program would not water for 5 more days, resulting in no irrigation for 10 days total.



## Run

After programming is complete, turn the dial to the **RUN** position to enable automatic execution of all selected programs and start times.

## System Off

Valves currently watering will shut off after the dial is turned to the **SYSTEM OFF** position for two seconds. All active programs will be discontinued and watering will stop. To return the controller to normal automatic operation, simply return the dial to the **RUN** position.

## Manually Run a Single Station

1. Turn the dial to the **MANUAL** position.
2. Station run time will flash in the display. Use the → button to move to the desired station. You may then use the + and - buttons to select the amount of time for a station to water.
3. Turn the dial to the **RUN** position to run the station. (Only the designated station will water, then the controller will return to automatic mode with no change in the previously set program.)



### Note

The Manual single station function ignores any attached sensor and will allow watering to occur.

## Seasonal Adjustment

Seasonal Adjust is used to make global run time changes without reprogramming the entire controller.

1. Turn the dial to the **SEASONAL ADJUST** position.
2. Press the + or - buttons to set the percentage desired from 5% to 300%.

To view the new adjusted run time, turn the dial to set the run time. The displayed run time will be updated accordingly as the seasonal adjustment is made.



### Note

The controller should always be initially programmed in the 100% position.

### One-Touch Manual Start and Advance

You can also activate a program to water without using the dial.

1. With the dial in the **RUN** position, hold down the → button for 2 seconds.
2. This feature automatically defaults to program **A**. You can select program **B** or **C** by pressing the PRG program.
3. The station number will flash. Press the ← or → button to scroll through the stations and use the + and - buttons to adjust the station run times.
4. Press the → button to scroll to the desired station. After a 2-second pause, the program will begin.

This feature is great for a quick cycle when extra watering is needed or if you would like to scroll through the stations to inspect your system.



### Set Pump/Master Valve (P/MV) Operation

All stations have the P/MV start circuit **ON** in the default setting.

To program P/MV operation:

1. Turn the dial to the **PUMP** position.
2. Press the + or - buttons to toggle the P/MV start **ON** or **OFF** for the specific station.
3. Press the → button to advance to the next station.
4. Repeat steps 2 and 3 for all necessary stations.

### Programmable Off

This feature permits the user to stop all programmed irrigation for a designated period from 1 to 99 days. At the end of the programmable off period, the controller will resume normal automatic operation.

1. Turn the dial to the **SYSTEM OFF** position.
2. Press the + button and a 1 will be displayed next to **OFF**.
3. Press the + button as many times as needed to set the number of days off desired (up to 99).
4. Turn the dial back to the **RUN** position. The controller is now set to **OFF** for the set number of days.

The days off remaining will decrease at midnight of each day. When it goes to zero, the display will show the normal time of day and normal irrigation will resume at the next scheduled start time.

## Hidden and Advanced Features

Feature	Where Found	Description
<b>Programmable Sensor Override</b>	Hold - and turn to Start Times	Sets individual stations to ignore sensor shutdowns. Select stations with ◀ or ▶, then use +/- to change to Off to ignore the sensor.
<b>Cycle and Soak</b>	Hold + and turn to Run Times; enter Cycle and press PRG to set Soak	Sets max time a station can run at once and minimum time it must wait before another cycle. Divides run time into segments to prevent runoff.
<b>Delay Between Stations</b>	Hold - and turn to Run Times	Inserts a delay (seconds or minutes) between stations in a run time for slow valves or recharging tanks.
<b>Hide Programs</b>	Hold - and turn to Water Days	Use +/- to change from 4 to 1 to hide extra programs. 1 will show only Program A, start time 1. 4 will show all programs (A, B, C) and 4 start times per program.
<b>Solar Sync Delay</b>	Hold + and turn to Solar Sync	Sets number of days before the Solar Sync Sensor begins adjusting run times. Allows landscape establishment for a set period of days before the sensor begins adjusting automatically.
<b>Click Delay</b>	Hold + and turn to Off	Set number of days for watering to remain off after sensor has been activated and restored.
<b>Total Run Time</b>	Turn to Run Times; press ◀ when station 1 is shown and PRG to select other programs	Calculates and displays the total of all run times in a program start time.
<b>Test Program</b>	Hold PRG 3 seconds	Runs all stations in the controller for the time entered for test or diagnostic purposes.
<b>Easy Retrieve® Memory</b>	Hold + and PRG to Save Hold - and PRG to Restore	Saves all program information to restore at a later time.
<b>Total Reset</b>	Press PRG and Reset button	Erases all watering information.
<b>Quick Check™ Technology</b>	+, -, ◀, ▶ together, then +	Checks all stations for wiring problems.
<b>Run Program</b>	Hold ▶, PRG to select	Runs all stations in selected program; use ▶ to advance to next station.
<b>Seconds Mode Run Times</b>	Hold + and turn to Start Times	Optional Seconds Mode allows for seconds of Run Time resolution, up to 5 minutes. Press + and - buttons to toggle between Seconds and Minutes Modes.



Feature	Where Found	Description
<b>Display shows ERR with number</b>	Short in field wiring or bad solenoid	Check field wiring and valve solenoid. Press any button to clear ERR message.
<b>Display shows P ERR</b>	Short in Pump/Master Valve wiring or solenoid	Check wiring and solenoid at P/MV. Check specifications for Pump Start Relay.
<b>Display shows SP ERR</b>	SmartPort error; electrical noise is present near connection to remote or other SmartPort device	Move connections away from sources of electrical noise.
<b>Display shows “No AC”</b>	There is no <b>AC</b> power to the controller	Check fuse/breaker and incoming power supply to controller.
<b>Display shows watering, but no watering is occurring</b>	Problem in field wiring; problem with solenoids; no water pressure to the system	Check field wiring (voltmeter). Check valve solenoid(s). Verify water source is open.
<b>Rain sensor does not stop irrigation</b>	Jumper wire is not removed; sensor switch in <b>BYPASS</b> position	Remove jumper wire on SEN-2 terminals. Set sensor switch to Active position.
<b>Controller seems to water continuously</b>	Too many start times	One Start Time operates all stations in a program. Remove unnecessary start times.

This equipment has been tested and found to comply with the limits for a Class B digital device pursuant to Part 15 of the FCC Rules. These limits are designed to provide reasonable protection against harmful interference in a residential installation. This equipment generates, uses, and can radiate radio frequency energy and, if not installed and used in accordance with the instructions, may cause harmful interference to radio communications. However, there is no guarantee that interference will not occur in a particular installation. If this equipment does cause harmful interference to radio or television reception, which can be determined by turning the equipment off and on, you are encouraged to try to correct the interference by taking one or more of the following measures:

- Reorient or relocate the receiving antenna.
- Increase the separation between the equipment and receiver.
- Connect the equipment into an outlet on a circuit different from that of which the receiver is connected.
- Consult the dealer or an experienced radio/TV technician for help.

Changes or modifications not expressly approved by Hunter Industries could void the user's authority to operate this device. If necessary, consult a representative of Hunter Industries Inc. or an experienced radio/television technician for additional suggestions.



**This product should not be used for anything other than what is described in this document. This product should only be serviced by trained and authorized personnel.**



---

Helping our customers succeed is what drives us. While our passion for innovation and engineering is built into everything we do, it is our commitment to exceptional support that we hope will keep you in the Hunter family of customers for years to come.

A handwritten signature in black ink that reads "Gene Smith". The signature is fluid and cursive, with a long horizontal stroke extending to the right.

**Gene Smith, President,  
Landscape Irrigation and Outdoor Lighting**

---

**HUNTER INDUSTRIES** | *Built on Innovation*<sup>®</sup>  
1940 Diamond Street, San Marcos, CA 92078 USA  
hunterindustries.com

© 2023 Hunter Industries™. Hunter, the Hunter logo, and all other trademarks are property of Hunter Industries, registered in the U.S. and other countries. ♻️ Please recycle.